





The stylized symbol  on the tile characterizes our communication.  
A contribution of value the Floor and Covering industry.







**01\_**

**Profiles for  
floors**

**02\_**

**Profiles for  
Stair nosing**

**03\_**

**Wall covering  
profiles**

**04\_**

**Expansion joints**

**05\_**

**Perimeter profiles for  
balconies**

**06\_**

**Mattings for tile  
installation**



prof



The Company page 6



Innovation page 14



Marketing page 18



Instructions and materials page 262



# Index



**07\_**

**Skirting boards and wall protection**

**08\_**

**Draining systems**

**09\_**

**Accessories for laying**

Profiles for floors page 28

**01\_**

Profiles for stair nosing page 74

**02\_**

Wall covering profiles page 100

**03\_**

Expansion joints page 142

**04\_**

Perimeter profiles for balconies page 180

**05\_**

Mattings for tile installation page 198

**06\_**

Skirting boards and wall protection page 208

**07\_**

Draining systems page 230

**08\_**

Accessories for laying page 246

**09\_**

## THE COMPANY

 Profilitec is an integral part of an industrial group, made up of companies in the field of micro precision engineering, high-tech mould production, advanced techno-polymers extrusion and the manufacturing of structural compounds.

The history of a company built one day at a time that takes pride in its exceptionally solid foundation.



**Since 1966 our group represents a benchmark producer in the profile sector.**

Over the years production has grown and diversified and we have thus matured as a company of high technical ability proposing a wide variety of innovative solutions for floor and wall coverings. Efficient logistics has allowed us to be present timely and effectively worldwide in the key markets of floors and coatings for interiors, design and construction. Prompt and active support provided by our staff, marketing materials, technical courses and training, allows us to be an important and key reference in our sector.





## INTEGRATED PRODUCTION

**+** The decision to manage all production processes internally in a vertical and integrated form enables us to keep know-how, service and performances at the highest level.

We have implemented innovative processes which position us at the top level in our sector, as a company of excellence at 360 degrees.

**Company 100% Made in Italy.**





Extrusion **1**



Forming **2**



Perforation **3**



Mechanical working **4**



Surface finishing **5**



Cold rolling **6**



Profile coating **7**

## THE VALUE OF IDEAS

**+** We believe that the intrinsic value of our ideas becoming facts, prevails over rhetoric. A disposition shared with thousands of our cherished customers worldwide, is the foundation of our 50 year history dedicated to wall and floor coverings.





## ETHICS AND SUSTAINABILITY

A constant attention to the processes and the management of resources is a commitment that each of us must respect regardless of profit or loss. Profilitec recycles all of the raw materials used in manufacturing with "on line" recovery systems.

Profilitec is certified UNI EN ISO 9001:2008 and consistently adheres to the highest standards in the field of quality and environmental protection.



## EFFECTIVE LOGISTICS

**+** Over 10.000 sq.m of warehouse surface with millions of metres of profiles stocked , ready for quick and punctual deliveries.





**Profilitec SpA guarantees its customers a reliable supply chain.**

As a company with more than 10.000 customers in more than 65 countries, we guarantee a service with fast and accurate deliveries worldwide. Profilitec is a guarantee for timely and accurate deliveries. Profilitec processes 99% of orders within 24 hours of receipt.



## A COMPLETE RANGE

**+** Innovation, design and range depth, are the elements that best characterize the product offering of Profilitec.

Solutions and answers are carefully planned, designed, realized and communicated for our worldwide dealers and installers.





**"Dove tailed"** mechanical anchoring.



2001



2003

Co-extrusion of different materials with re-use in line of the flange off-cut.

**Multiclip system**  
A revolution in the laminate floor installation.



2004

**Clip System**  
A modular way to match profiles with infinite possibilities.



2005

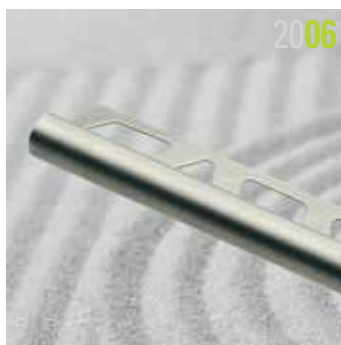

2006

Birth of the **stainless steel** range, with a unique programme of models and finishes.

**Jointec**  
Technical improvement with a series of expansion joints, especially structural.

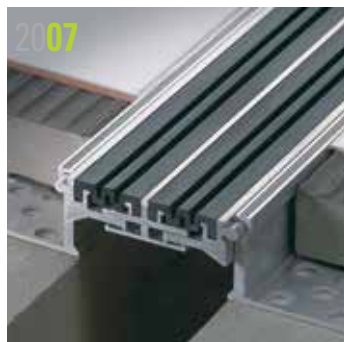

2007



2008

**Mosaictec Series**, to solves specific problems for thin tiles with special attention to well finished detail.

# BORDER COLLECTION



# SKIRTING

Una gamma completa di profili perimetrali e di finitura per interni e esterni. L'ampio ventaglio di soluzioni per esterni offre un'ampia gamma di colori e finiture. I vantaggi di questo sistema di finitura per esterni sono: alta resistenza, lunga durata, facile installazione e manutenzione.

A complete range of profiles and panels for interior and exterior use. The wide range of exterior solutions offers a wide range of colors and finishes. The advantages of this exterior finishing system are: high resistance, long life span, easy installation and maintenance.

Una gamma completa di finiture per interni e esterni. I vantaggi di questo sistema di finitura per interni sono: alta resistenza, lunga durata, facile installazione e manutenzione.

An extensive range of interior skirting profiles offering an alternative to traditional wood and plastic profiles. Design provides functional solutions, the plastic skirting is durable and resistant to harsh conditions. In addition, it provides the additional benefit of being low voltage-cableing such as telephones, TV and computer cables.

## PATENTS

+ “Everyone knows that something is impossible to invent, until an inexperienced person comes along and invents it...” Albert Einstein.

Profiltec boasts an impressive number of patents and inventions.





A wider skirting range- technical and design.



**SWR** Stainless steel elements make your stair not only safe but beautiful. Another example of creativity.



**Plano Design** the first skirting board flush to the wall, is an innovation perfectly aligned with our company DNA.



New innovative technical solutions for terraces meeting the market needs.



**Appendo**, a vertical decorative listello with integrated hook.



**Leveltec**  
Level just with a click. Even an apparently simple product can contain extraordinary ideas and innovations.





## EDUCATIONAL

**+** Knowledge becomes a value once it is effectively packaged and communicated to the market. A highly important task which Profilitec professionals perform daily in their service to architects, contractors, installers, distributors and end users.





#### Training and technical support

Technical training, communicated with various educational formats to all industry participants, provides a significant advantage to our customers when choosing the right technical solution to a product or installation problem.

For this Profilitec provides qualified personnel for training and continued education to customers and their clients.

The company's technical department is always available to support both design and installation.



GENERAL COLLECTION

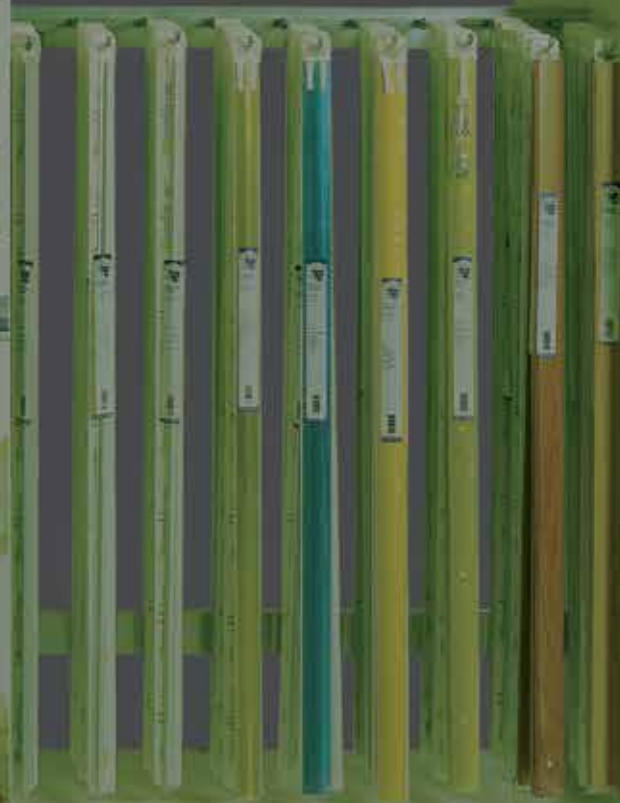

GENERAL COLLECTION



PROBLEMI-SOLUZIONI

PROBLEMI-SOLUZIONI

FAMIGLIA PRODOTTI  
PRODUCT FAMILY

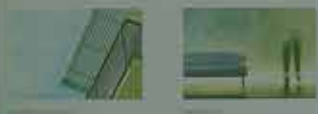

**MARKETING**

**+** Innovative marketing tools to propose new technical solutions to customers.  
Point-of-sale displays and showroom displays.  
Full and detailed product catalogues and sample boxes.  
Product samples for the right solution .



DISPLAYS



CATALOGUES AND FAMILY SAMPLE FOLDERS



BLOG



SPECIAL SAMPLE FOLDERS



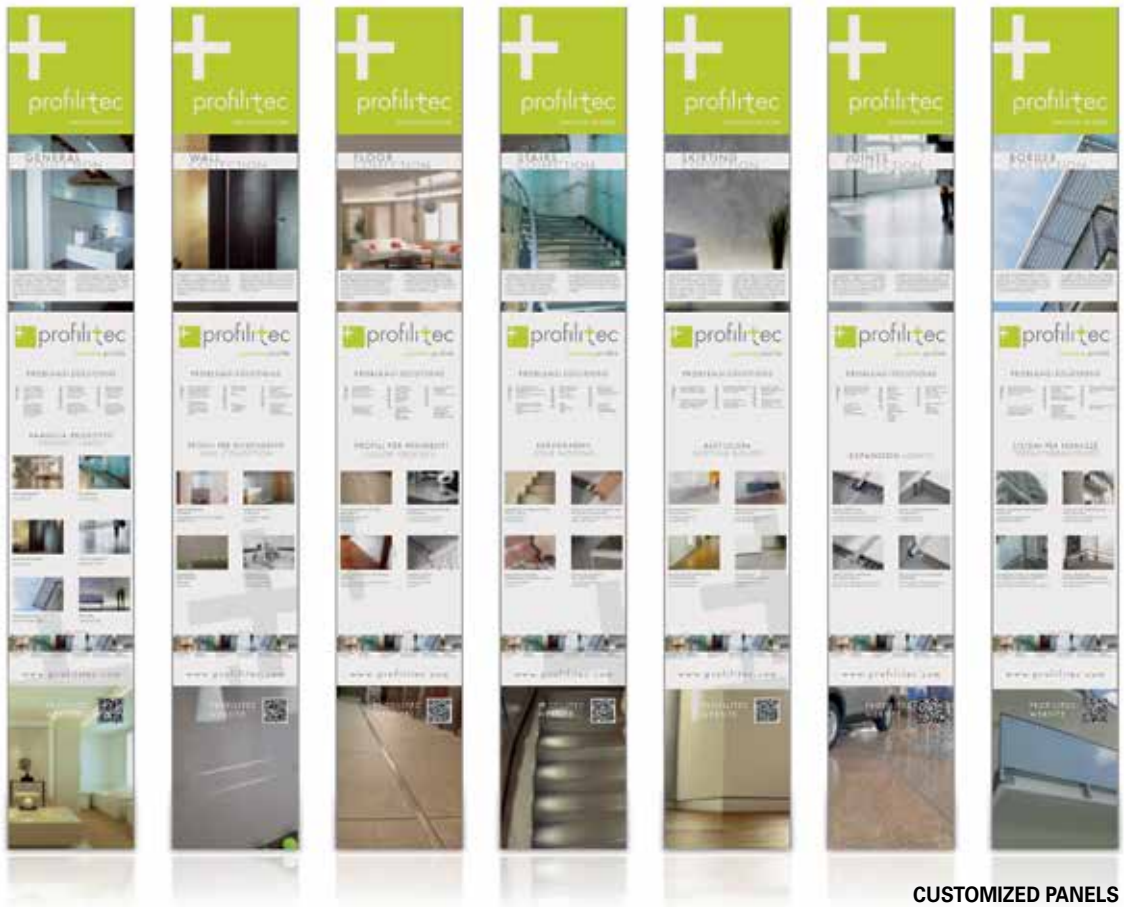

CUSTOMIZED PANELS



PROFESSIONAL DISPLAY STAND



# showroom displays



An effective and well thought through presentation and stocking of profiles in the shop, warehouse and showroom, is part of Profilitec's offering to clients, permitting the orderly and elegant communication of Profilitec product range. The proposed solutions are designed with attention, attributing the right value to the product in its context and the spaces provided by our customers.



PANELS



SALES POINT DISPLAY



**COMPANY PROFILE**



**SKIRTING MOCK-UP**



**GENERAL CATALOGUE**



**PRICE LIST**



**PRODUCT FAMILY BROCHURE**





# catalogues and sample folders



Profilitec SpA has created a unique marketing tool : the DOX sample folder.

11 different folders tell the full story of all our product families in a comprehensive and graphic manner.

In the DOX sample folder you can touch the products and consult all the technical detail relative to the available products' measures and finishes.

The DOX is enriched with a series of photos of applications where you can appreciate the profiles installation.

For the transport we have conceived a user-friendly trolley which can include the complete DOX series.



FAMILY SAMPLE FOLDERS SET



SAMPLE FOLDERS SET TROLLEY

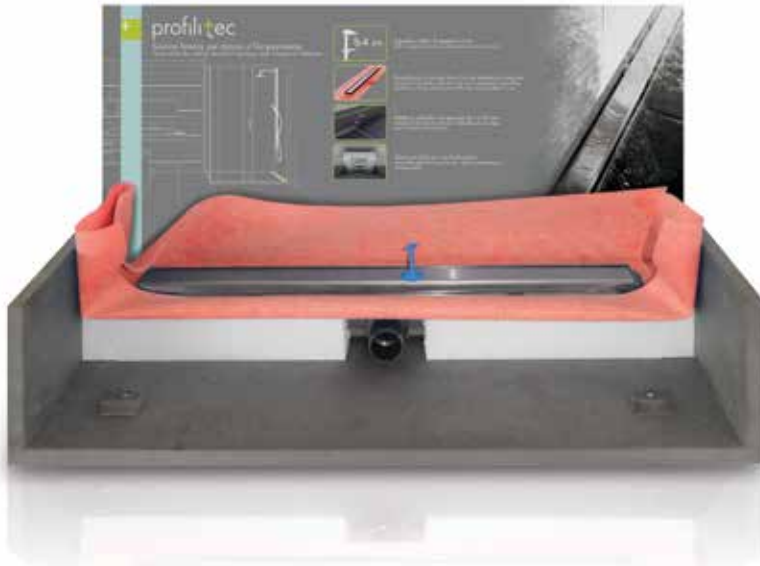

**VISUAL DRAIN DISPLAY**



**MULTIDRAIN DISPLAY**



**LEVELTEC COUNTER DISPLAY**



**SAMPLE CASES**



**SAMPLE BOX  
PROFILES SELECTION AND LEVELTEC**





prof

sample folders



SPECIAL SAMPLE FOLDER

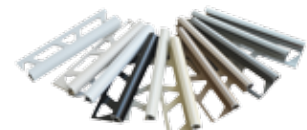
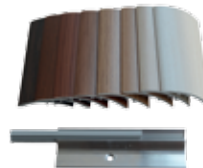

SAMPLE SWATCHES





## Profiles for floors

01\_

Jointing of different material coverings, compensation of differing heights, contouring of edges, terminal finish with traditional profile materials or innovative ones to provide to modern look.

A complete range of profiles for floor coverings created specifically for tile and marble laying and a comprehensive series of profiles suitable for edging and finishing a large variety of coverings known on the market.

We offer both technical and decorative solutions. Simple sections for essential, discreet finishes. Or more decorative solutions, which add aesthetically to surfaces while remaining in harmony with surroundings and ceramics a vast range to offer specific solutions aimed at guaranteeing a state of the art detailed floor covering job.

Article		Use	Pag.
Trimtec	TR	multipurpose	30
Trimtec	SR	edge finish	32
Bordertec	BSR	terminal prof. for elevated floors	33
Roundjolly	RJ	ultra-thin tiles	34
Mosaictec	SJM	ultra-thin tiles	35
Squarejolly	SJ	junction	36
Cubetec	CU-FI	junction	38
Covertec	EP	junction	39
Roundtec	RD	transition	40
Zerotec	ZRM	transition	41
Zerotec	ZR	junction ramp	42
Ramptec	ZRR	junction ramp	43
Linetec	AD	separation profile	44
Linetec	MB	separation profile	45
Linetec	PT	separation profile	46
Curveline		bending equipment	47
Covertec	SP	junction	48
Striptec	ST	existing floors	50
Striptec	ST/SB	existing floors	51
Leveltec	RP	existing floors	52
Leveltec	RP	existing floors	53
Variotec	DC	edge strip	54
Variotec	DK	edge strip	55
Variotec	DR/DS/LS	compensating edge	56
Leveltec - Linetec	ZP/PR/PQ/PU	junction	57
Multiclip®		multiclip	58
Multiclip®	CLG 370	multiclip	59
Multiclip®	CLF 450	multiclip 6÷11 mm	60
Multiclip®	CLF 490	multiclip 12÷18 mm	61
Multiclip®	CLP 270	multiclip perimeter	62
Multiclip®	CLS 250	multiclip stairnosing	63
Multifix	CLG 300	multifix	64
Multiclip® - Multifix		assembly multiclip-multifix	65
Multicover		multicover wood	66
Woodtec	LT	edge for wooden floors	67
Woodtec	LP	edge for wooden floors	68
Woodtec	LG	junction	69
Carpetec	MG	carpet junction	70
Carpetec	MP	edge	71
Carpetec	MA/MS/MD	carpet edge	72
Linotec	AP/AV/SC	edge PVC	73





trimtec™ TR

**TRIMTEC TR** is a complete range of brass, aluminium and stainless steel trim profiles designed to allow a faster and proper laying of floor coverings independent of tile size or type of finishing and edging required.

**TRIMTEC TR** is supplied in different heights ranging from 2 mm to 30 mm to match the thickness of tiles normally produced. In the aluminium and brass version, the dovetail internal cavity groove of the profile improves the grip action of the grout whether for vertical or horizontal tile laying.

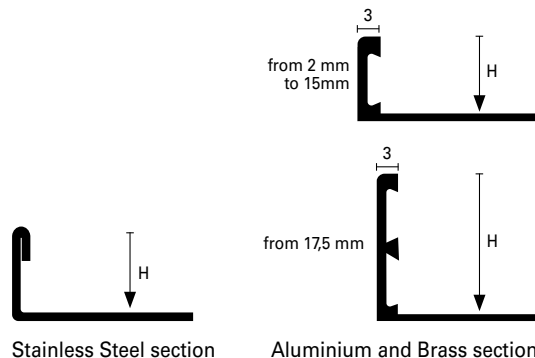

(TR 100\* - TR 175\*)

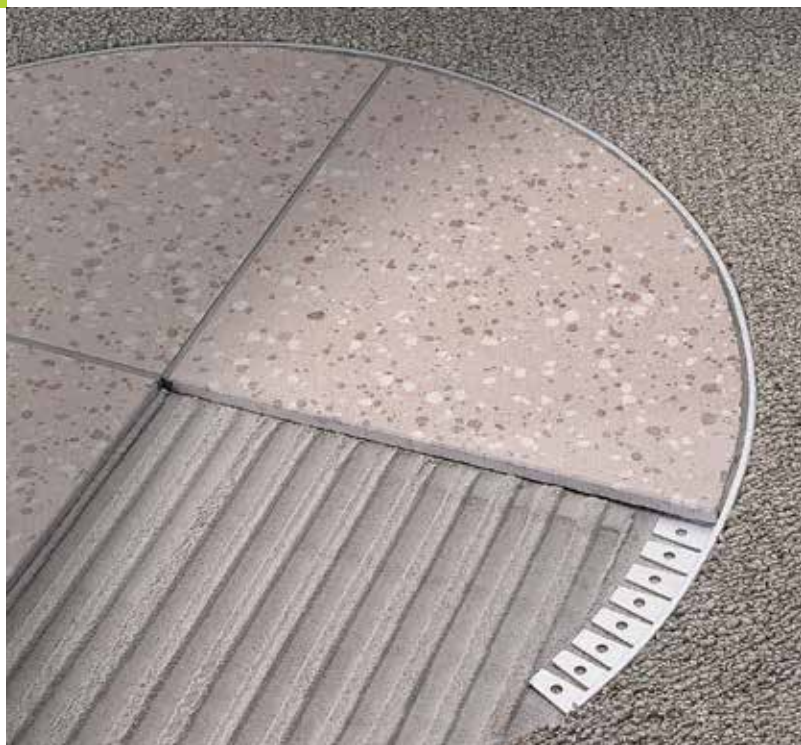
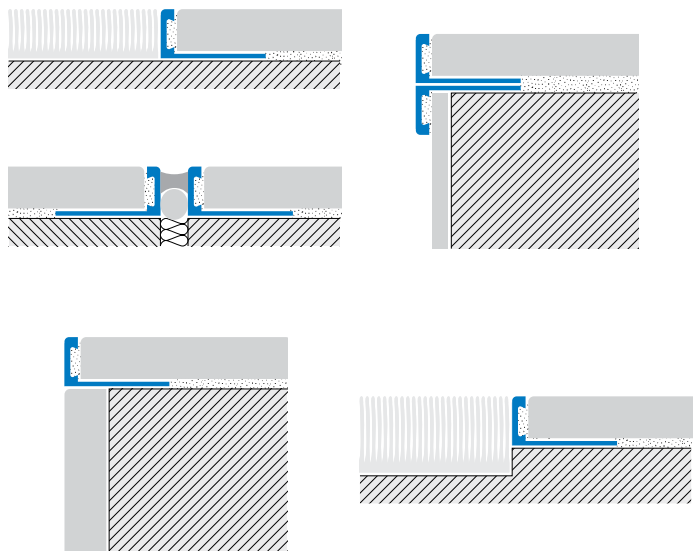

**TRIMTEC TR** profiles are conceived for tile laying but can be well used also with other types of flooring such as marble stone, wood, industrial resin floors, and natural stone floors.

**TRIMTEC TR** are mainly used as transition trims between two types of floors (between tiling and carpeting for instance) and are adaptable as expansion joints when 2 lengths are laid face to face with filler poured in the gap. They can be used as ceramic skirting edging as well as terminal finish and protection for any given height of the floored area. In some cases also as entrance mat framing.





#### TRIMTEC TR-O\* Extruded Brass

This brass profile is developed with prime choice raw material in order to guarantee tolerance and endurance to chemical and mechanical solicitations. It is quite suitable for heavy industrial traffic areas as well as for domestic use where brass is always appreciated. Through contact with moisture or corrosive media brass may oxidize on exposed surfaces. This situation can be easily solved by buffing the product with to conventional polisher to return to its original shine.

Available in natural brass (ON) or polished brass (OL): minimum qty required for this option.

#### TRIMTEC TR-I\* Stainless Steel AISI 304 - DIN 1.4301 e AISI 316 DIN 1.4401

This stainless steel profile is AISI 304 standard which ensures high tolerance to most of diluted chemicals found in laboratories or strong detergents present in food processing plants, commercial kitchens, slaughter houses, breweries, public toilets, hospitals etc.

Available in polished stainless steel (IL), brushed (IS) or sanded (IX).

#### TRIMTEC TR-AN Natural aluminium

This profile is developed in conformity with the UNI standards. It has little tolerance to mechanical or chemical solicitation. During installation, excess adhesive and grout should be removed immediately to avoid stains. The exposed surface may change colour or darken in time. Outdoors or where higher stresses are involved the use of brass profiles is recommended.

#### TRIMTEC TR-AS Silver Anodised Aluminium

This profile has a silver coating and is suitable for both indoor or outdoor application with high tolerance to weather agents but less to mechanical impact. During installation, excess adhesive and grout should be removed immediately to avoid stains. The exposed surface may change colour or darken in time. Where higher stresses are involved the use of brass profiles is recommended.

#### CURVELINE

TRIMTEC TR series are also available with to special cut flange so they become formable for curved edges and inlays. To order: add the letter D to the product code – for further details see page 47.

#### INSTALLATION:

- 1) Choose the trim size according to the thickness of the tile. The trim must not exceed the height of the tile but should be at least  $0.5 \div 1$  mm lower.
- 2) Apply tile adhesive to area to be tiled.
- 3) Cut trim to required length. Reserve extra space for linear expansion. The perforated flange of the trim is then firmly bedded into the adhesive and aligned.
- 4) Trowel extra adhesive over the perforations and the dovetail groove in the vertical section.
- 5) A tiny gap of approx.  $0.5 \div 2$  mm is left between trim and tile for the final grouting to be carried out.

	H=mm		Art.	
Material:	2	TR	20	ON/OL
Extruded Brass	3	TR	30	ON/OL
Finish*: Natural (ON), Polished (OL)	4,5	TR	45	ON/OL
	6	TR	60	ON/OL
Length: 2,70 metres	8	TR	80	ON/OL
	10	TR	100	ON/OL
⚠: 0,90 / 1,35 metres	12,5	TR	125	ON/OL
	15	TR	150	ON/OL
⚠ "ultra-thin tiles"	17,5	TR	175	ON/OL
	20	TR	200	ON/OL
	22,5	TR	225	ON/OL
	25	TR	250	ON/OL
	27,5	TR	275	ON/OL
	30	TR	300	ON/OL

Material:	4,5	TR	45	IL/IS/ILM
Stainless Steel AISI 304	6	TR	60	IL/IS/ILM
Stainless Steel AISI 316 (ILM)	8	TR	80	IL/IS/ILM
Finish*: Polished (IL), Brushed (IS), Sanded (IX)	10	TR	100	IL/IS/IX/ILM
	11	TR	110	IL/IS/IX/ILM
Length: 2,70 metres	12,5	TR	125	IL/IS/IX/ILM
	15	TR	150	IL/IS/ILM
⚠: 0,90 / 1,35 metres (only IL)	17,5	TR	175	IL/IS
	20	TR	200	IL/IS
⚠ "ultra-thin tiles"	22,5	TR	225	IL/IS
	25	TR	250	IL/IS
	27,5	TR	270	IL/IS
	30	TR	300	IL/IS

Material:	2	TR	20	AN
Extruded Aluminium	3	TR	30	AN
Finish: Natural (AN)	4,5	TR	45	AN
	6	TR	60	AN
Length: 2,70 metres	8	TR	80	AN
	10	TR	100	AN
⚠: 0,90 / 1,35 metres	11	TR	110	AN
	12,5	TR	125	AN
⚠ "ultra-thin tiles"	15	TR	150	AN
	17,5	TR	175	AN
	20	TR	200	AN

Material:	2	TR	20	AS
Anodised aluminium	3	TR	30	AS
Finish: Silver (AS)	4,5	TR	45	AS
	6	TR	60	AS
Length: 2,70 metres	8	TR	80	AS
	10	TR	100	AS
⚠: 0,90 / 1,35 metres	11	TR	110	AS
	12,5	TR	125	AS
⚠ "ultra-thin tiles"	15	TR	150	AS
	17,5	TR	175	AS
	20	TR	200	AS

⚠: Pre-cut length available in SELFLINE kit L= 0,90/1,35 m





trimtec™ SR

**TRIMTEC SR** is recommended in particular for finishing the edges of the perimeter of the ceramic floors, especially where they abut to vertical covering, or as stair nosing, as well as for trimming external access ways and balconies. SR trim has an extended vertical edge which serves to better cover and protect the joining surfaces or paint finishing as well as to prevent future fissuring. Its particular section design makes it suitable to match two different floor thicknesses with the same reversible profile. Vertical dovetail anchorage.

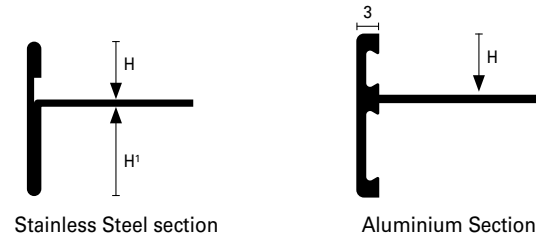

Stainless Steel section

Aluminium Section

(SR 8/15\*)

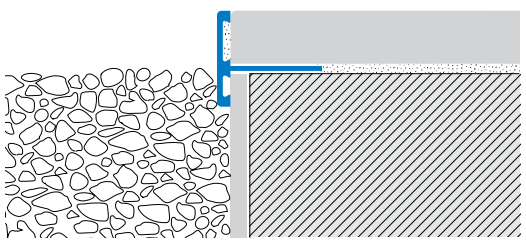

**TRIMTEC SR-O\* Extruded Brass**

This brass profile is developed with prime choice raw material in order to guarantee tolerance and endurance to chemical and mechanical solicitations. Through contact with moisture or corrosive media, brass may oxidize on exposed surfaces. This situation can be easily solved by buffing the product with a conventional polisher to return to its original shine. Available in natural brass (ON) or polished brass (OL).

**TRIMTEC SR-AS Silver Anodised Aluminium**

This profile has to silver coating and is suitable for both indoor or outdoor application with high tolerance to weather agents but less to mechanical impact. During installation, excess adhesive and grout should be removed immediately to avoid stains. The exposed surface may change colour or darken in time. Where higher stresses are involved the use of brass profiles is recommended or Stainless Steel.

**TRIMTEC SR-I\* Stainless Steel AISI 304 - DIN 1.4301**

This stainless steel profile is AISI 304 standard which ensures high tolerance to most of diluted chemicals found in laboratories or strong detergents present in food processing plants, commercial kitchens, slaughter houses, breweries, hospitals, public toilets etc. Available in polished stainless steel (IL), brushed (IS) or sanded (IX).

**CURVELINE**

TRIMTEC SR series are also available with to special cut flange so they become formable for curved edges and inlays. To order: add the letter D to the product code.

	H=mm	Art.		
Material: Extruded Brass	8/15 10/12,5	SR SR	8/15 10/12	ON/OL ON/OL
Finish*: Natural (ON), Polished (OL)				
Length: 2,70 metres				

Material: Extruded anodised aluminium	8/15 10/12,5	SR SR	8/15 10/12	AS AS
Finish: Silver (AS)				
Length: 2,70 metres				

Material: Stainless Steel AISI 304	8/15 10/12,5	SR SR	8/15 10/12	IL/IS IL/IS
Finish*: Polished (IL), Brushed (IS)				
Length: 2,70 metres				







The **BORDERTEC BSR** is recommended to contour marble and stone balconies and terraces with to water-run-off finishing element. Its reversible section allows to match two different tiles' thicknesses with the same reversible profile. Bordertec BSR is equipped with the necessary special pieces for a proper installation.  
(One corner works also as two junctions).

# border+tec BSR

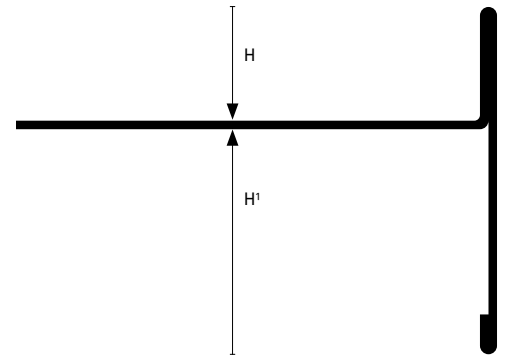

(BSR 15/30\*)

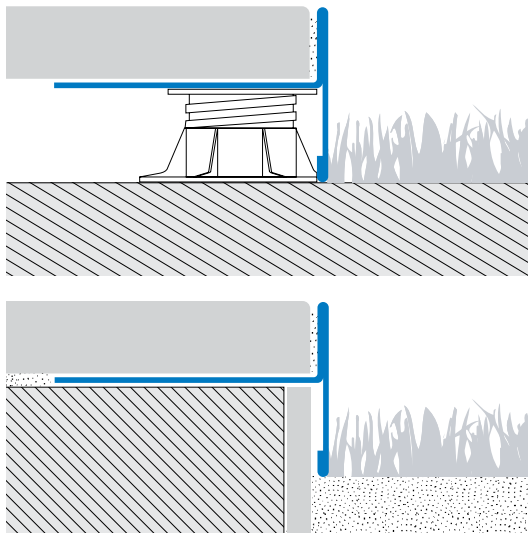

### BORDERTEC BSR-A\* Powder Coated Aluminium

Profile coated on its entire surface with polyester powder.  
(\* ) Available on request also in grey (A22) and micaceous grey (A50).

External corner piece: Code BSRE-A22/A50  
Junction piece: codeBSRG-A22/A50

### BORDERTEC BSR-IL Polished Stainless Steel AISI 304 - DIN 1.4301

Polished Stainless Steel AISI 304 ensures high resistance to most diluted chemical agents.

External corner piece: Code BSRE-IL  
Junction piece: codeBSRG-IL

	H=mm	Art.		
Material:	15/30	BSR	15/30	A22/A50
Alluminium verniciato	20/25	BSR	20/25	A22/A50
Finish*: Grey (A22), Micaceous grey (A50)	10/35	BSR	10/35	A22/A50
Length: 2,70 metres	20/40	BSR	20/40	A22/A50*
	20/60	BSR	20/60	A22/A50*
	20/80	BSR	20/80	A22/A50*
	20/100	BSR	20/100	A22/A50*

Material:	15/30	BSR	15/30	IL
Stainless Steel AISI 304	20/25	BSR	20/25	IL
Finish: Polished (IL)	10/35	BSR	10/35	IL
Length: 2,70 metres				



The **ROUNDJOLLY®** profiles connect floors of different levels, completing and protecting the tile edge from bangs and mechanical impacts. The profile, available in aluminium and stainless steel is ideal for restructuring and on surfaces covered with thin tiles.

roundjolly™ RJ



Stainless Steel section



Aluminium section

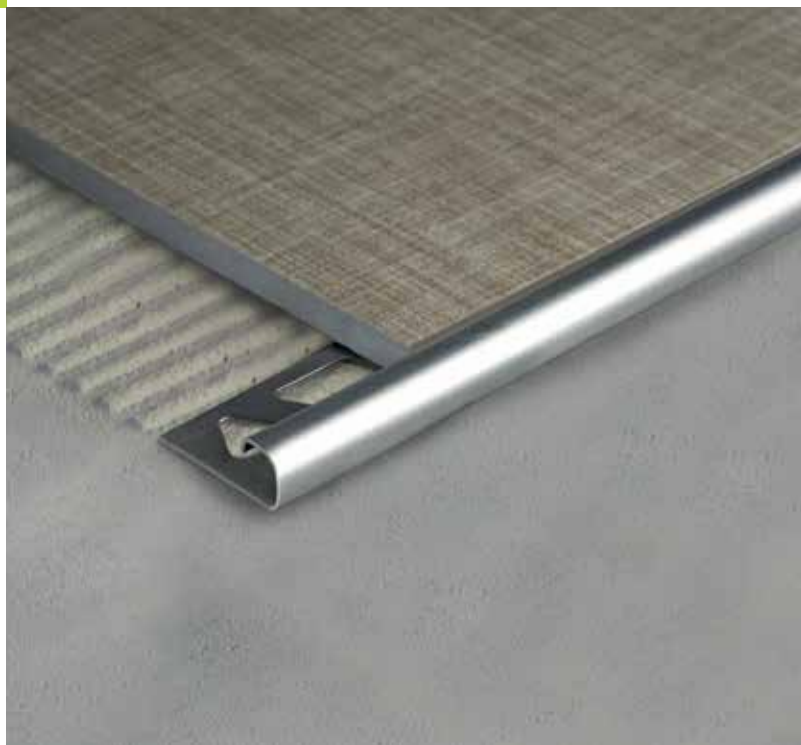
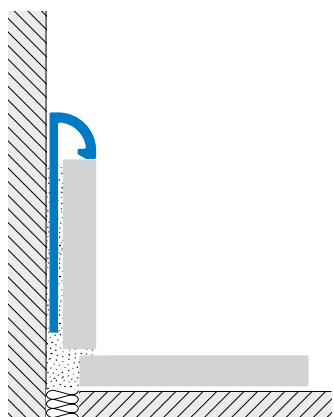

**ROUNDJOLLY® RJ-AS Silver Anodised Aluminium**

A silver coated aluminium profile which offers adequate protection and tolerance to wear over time page 107.

**ROUNDJOLLY® RJ-I\* Stainless Steel AISI 304 DIN 1.4301**

Stainless steel ensures excellent resistance to most chemicals, so it is ideal in the food, chemical and hospital areas.

Available in polished stainless steel (IL) and brushed (IS)

Special end-cap RJC available, see page 107.

	H=mm	Art.		
Material: Extruded anodised aluminium	4,5	RJ	45	AS
Finish: Silver (AS)				
Length: 2,70 metres				
☒ "ultra-thin tiles"				

Material: Stainless Steel AISI 304	4,5	RJ	45	IL/IS
Finish*: Polished (IL), Brushed (IS)				
Length: 2,70 metres				
☒ "ultra-thin tiles"				





# mosaictec *SJM*

**MOSAICTEC SJM** is a multipurpose profile to match floor and wall coverings or used as edgings or decorative listellos, with a perfect symmetry of the 2 visible sides.

This profile has been specially conceived for thin floors and mosaics, its reduced wing size and thickness is designed to provide the perfect solution for the neat finishing of mosaic tesseras, ensuring a neat, level surface finish.

MOSAICTEC SJM belongs to a complete series of solutions for mosaics. A special cubic end cap is available, multipurpose to match with all installation needs.

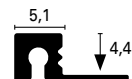

### MOSAICTEC SJM 44 AS Silver Anodised Aluminium

This profile has a silver coating and is suitable for both indoor or outdoor application with high tolerance to weather agents but less to mechanical impact. During installation, excess adhesive and grout should be removed immediately to avoid stains.

### MOSAICTEC SJC 44 AS Capsula Silver Anodised Aluminium

Capsules to make external, internal, three-way junction and end-cap. The profile symmetric section has been conceived to match all these functions with one piece.

For the complete range of finishes, please see the wall covering section.

	H=mm	Art.		
Material: Extruded anodised aluminium	4,4	SJM	44	AS
Finish: Silver (AS)				
Length: 2,70 metres				
"ultra-thin tiles"				

Material: Extruded anodised aluminium	4,4	SJC	44	AS
Finish: Silver (AS)				
"ultra-thin tiles"				



squarejolly™ SJ

**SQUAREJOLLY SJ** is a multipurpose aluminium profile suitable for many different situations arising in thin bed adhesive tile coverings.

This special 'symmetrical square' profile is recommended for multiple finishing effects.

In the drawing "H" corresponds to the tile thickness and "B"= H+1 mm to the visible part.

Anchorage improved on vertical side with the "dovetail" internal cavity. Patented system (aluminium version).

The particular section of the SJ profile by Profilitec, with the 2 vertical sides directly in touch with the adjacent surfaces make it perfect also for floor applications and ensure its resistance to loads.

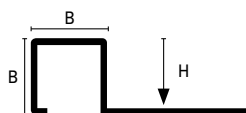

Stainless Steel and brass section

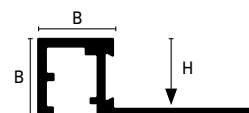

Aluminium section

(SJ 90\*)

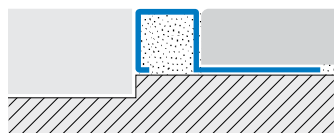

**SJ profile is a multipurpose profile for a wide range of applications:**

- Junction of floors at the same level
- Decorative listellos
- Finishing the outer edges of wall tiles
- Entrance mat framing
- Upper finish of tiled skirting and edges
- Stair nosing profiles

For the complete range of finishes, please see the wall covering section.

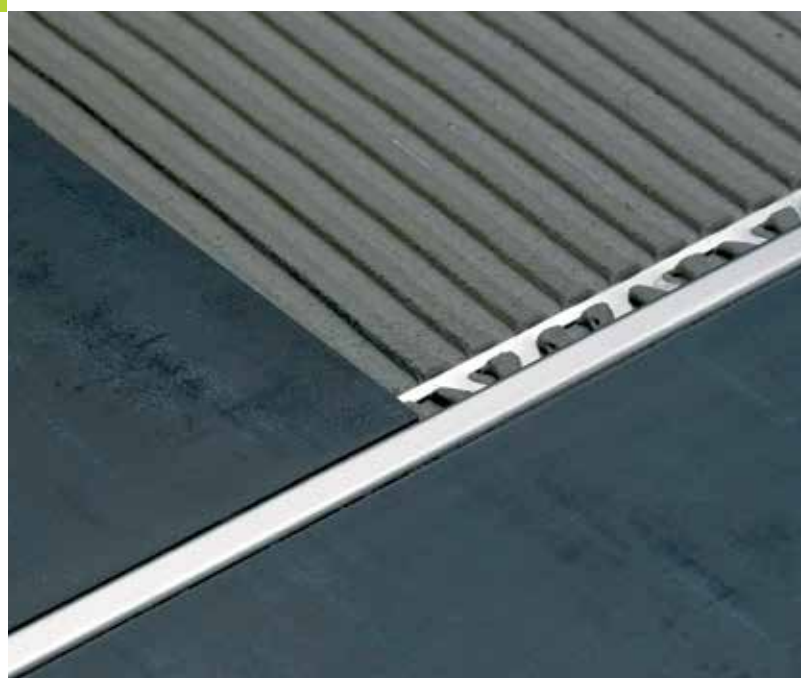



The profile inner section has been conceived to match with a special cap SQUARECAPSULE SJC which can work as external, internal, three-way junction and end-cap. All these functions with one piece.

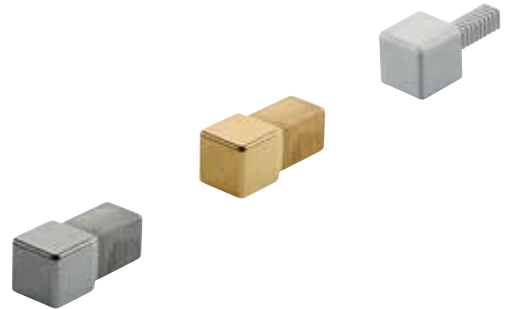

**SQUAREJOLLY SJ-I\* Stainless Steel AISI 304 - DIN 1.4301 e AISI 316**

This stainless steel profile is AISI 304 standard which ensures high tolerance to most of diluted chemicals found in laboratories or strong detergents present in food processing plants, commercial kitchens, slaughter houses, breweries, hospitals, public toilets etc.

The choice of AISI 316 as standard is suggested for marine environments and in case of exposition to harsher chemical agents.

Available in polished stainless steel (IL), brushed (IS) and sanded (IX).

	H=mm		Art.	
Material:	6	SJ	60	IL/IS
Stainless Steel AISI 304	8	SJ	80	IL/IS/IX/ILM
Stainless Steel AISI 316 (ILM)	9	SJ	90	IL/IS/ILM
Finish*: Polished (IL), Brushed (IS), Sanded (IX)	10	SJ	100	IL/IS/IX/ILM
	11	SJ	110	IL/IS/ILM
Length: 2,70 metres	12,5	SJ	125	IL/IS/IX/ILM
	15	SJ	150	IL/IS/ILM

**SQUAREJOLLY SJ-AS Silver Anodised Aluminium**

This profile has a silver coating and is suitable for both indoor or outdoor application with high tolerance to weather agents but less to mechanical impact. During installation, excess adhesive and grout should be removed immediately to avoid stains. The exposed surface may change colour or darken in time. Where higher stresses are involved the use of brass or stainless steel profiles is recommended.

Material:	6	SJ	60	AS
Extruded anodised aluminium	8	SJ	80	AS
Finish: Silver (AS)	9	SJ	90	AS
	10	SJ	100	AS
Length: 2,70 metres	11	SJ	110	AS
	12,5	SJ	125	AS

**SQUAREJOLLY SJ-OL Polished Brass**

This brass profile is developed with prime choice raw material in order to guarantee tolerance and endurance to chemical and mechanical solicitations. Through contact with moisture or corrosive media, brass may oxidize on exposed surfaces. This situation can be easily solved by buffing the product with a conventional polisher to return to its original shine.

Material:	8	SJ	80	OL
Brass	10	SJ	100	OL
Finish: Polished (OL)	12,5	SJ	125	OL
	Length: 2,70 metres			

**SQUARECAPSULA SJC\***

The profile inner section has been conceived to match with a special cap which can work as external, internal, three-way junction and end-cap. All these functions with one piece.

Material:	6	SJC	60	*
Alluminium / Brass / Stainless steel	8	SJC	80	*
	9	SJC	90	*
	10	SJC	100	*
	11	SJC	110	*
	12,5	SJC	125	*
	15	SJC	150	*





**CUBETEC** gives a straight and decorative finish, providing long lasting and heavy duty tile edge protection. The model **CUBETEC** is used with floor covering materials to provide decorative joints while protecting tile edges or to link to other materials, as well as frame for welcome mats. Available in Polished Stainless Steel AISI 304, in two different widths of the visible side. Vertical dovetail anchorage.

# cubetec™ CU-FI

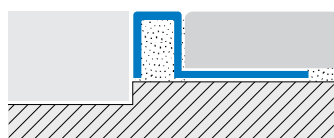
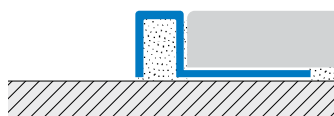
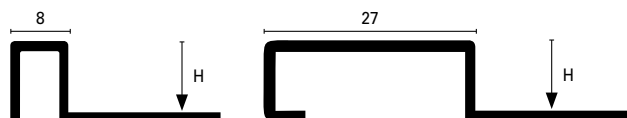

### CUBETEC CU-I\* Stainless Steel AISI 304 - DIN 1.4301

This stainless steel profile is AISI 304 standard which ensures resistance to corrosion. Visible side width 8 mm.

Available in polished stainless steel (IL) and brushed (IS).

### CUBETEC FI-I\* Stainless Steel AISI 304 - DIN 1.4301

This stainless steel profile is AISI 304 standard which ensures resistance to corrosion. Visible side width 27.

Available in polished stainless steel (IL) and brushed (IS)

	H=mm	Art.		
Material:	8	CU	80	IL/IS
Stainless Steel AISI 304	10	CU	100	IL/IS
Finish*: Polished (IL), Brushed (IS)	12,5	CU	125	IL/IS
Length: 2,70 metres				

Material:	8	FI	80	IL/IS
Stainless Steel AISI 304	10	FI	100	IL/IS
Finish*: Polished (IL), Brushed (IS)	12,5	FI	125	IL/IS
Length: 2,70 metres				



covertec™ EP

**COVERTEC EP** is a profile joining two adjacent surfaces of different floor covering material (cement/ceramic or wood/ceramic or with other resin or vinyl flooring combinations) allowing an invisible movement zone, therefore performs also as to movement joint as well as a decorative finishing trim. It also covers slight imperfections of junctions and cuts for floor separation. Aluminium and brass, vertical dovetail anchorage. Patented.

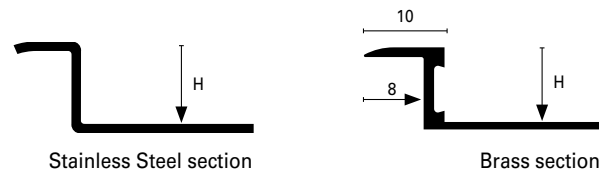

(EP 100\*)

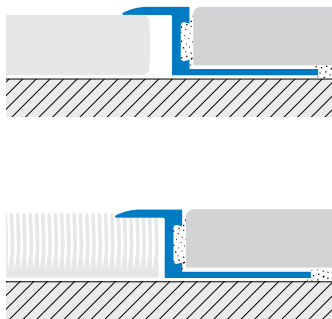

**COVERTEC EP-O\* Extruded Brass**

This brass profile is developed with prime choice raw material in order to guarantee tolerance and endurance to chemical and mechanical solicitations. It is primarily applied on both indoor and outdoor floors and can bear intense transit areas as well as for detailing elegant residential coverings. Through contact with moisture or corrosive media, brass may oxidize on exposed surfaces. This situation can be easily solved by buffing the product with a conventional polisher to return to its original shine. Available in natural brass (ON) or polished brass (OL).

	H=mm		Art.	
Material:	8	EP	80	ON/OL
Extruded Brass	10	EP	100	ON/OL
Finish*: Natural (ON), Polished (OL)	12,5	EP	125	ON/OL
Length: 2,70 metres				

**COVERTEC EP-IL Polished Stainless Steel AISI 304 - DIN 1.4301**

This stainless steel profile is AISI 304 standard which ensures high tolerance to most of diluted chemicals found in laboratories or strong detergents present in food processing plants, commercial kitchens, slaughter houses, breweries, hospitals, public toilets etc.

Material:	8	EP	80	IL
Stainless Steel AISI 304	10	EP	100	IL
Finish*: Polished (IL)	12,5	EP	125	IL
Length: 2,70 metres				



roundtec™ RD

This profile **ROUNDTEC RD** is mainly utilized for adjacent floors of different levels as for instance the joining of to ceramic floor to a thinner linoleum or other types of vinyl and resin surface. Its rounded section conveys to virtually ideal vertical drop of 3 mm to the lower adjacent floor surface and at the same time protects the tile edge with a touch of elegance, other applications are stair nosing or finishing of tiled kitchen tops and counters. Vertical dovetail anchorage. Patented.



(RD 100 O\*)

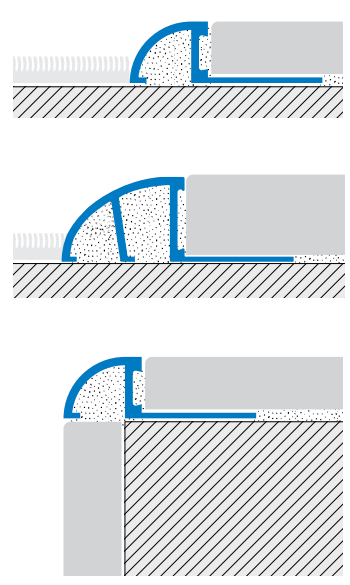

**ROUNDTEC RD-O\* Brass**

This brass profile is developed with prime choice raw material in order to guarantee tolerance and endurance to chemical and mechanical solicitations. It is primarily applied on both indoor and outdoor floors and can bear intense transit areas as well as for detailing elegant residential coverings. Through contact with moisture or corrosive media, brass may oxidize on exposed surfaces. This situation can be easily solved by buffing the product with a conventional polisher to return to its original shine. Available in natural brass (ON) or polished brass (OL).

	H=mm	Art.		
Material:	8	RD	80	ON/OL
Extruded Brass	10	RD	100	ON/OL
Finish*: Natural (ON), Polished (OL)	12,5	RD	125	ON/OL
	15	RD	150	ON/OL
Length: 2,70 metres				





**ZEROTEC ZRM** profile is the ideal solution for joining two floors at different levels, between a ceramic covering and one in moquette carpeting for instance. This trim allows a 4 mm progressive sloping difference to the next floor to match thus making safer when treading over the connecting floors. The ramp inclination has been conceived for vehicle and wheel carts transit.

# zerotec™ ZRM

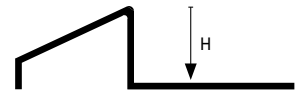

(ZRM 100 IL)

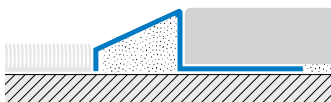

### ZEROTEC ZRM-IL Polished Stainless Steel AISI 304 - DIN 1.4301

This stainless steel profile is an AISI 304 standard which ensures high tolerance to most of diluted chemicals found in laboratories or strong detergents present in food processing plants, commercial kitchens, hospitals, public toilets, slaughter houses, breweries, etc.

	H=mm	Art.		
Material: Stainless Steel AISI 304	8	ZRM	80	IL
	10	ZRM	100	IL
Finish: Polished (IL)	12,5	ZRM	125	IL
Length: 2,70 metres				



zerotec™ ZR

**ZEROTEC ZR** trim allows the installer to perfectly join the height difference created when laying new floor covering over an existing one. Its ramp angle inclination has been conceived to bear intense transit of vehicles or wheeled carts in garage areas and shopping centers always maintaining total protection to the various edges of tiled floors. This profile contributes to safety when treading over connecting floors. For high traffic industrial and commercial areas we suggest to prefer the brass option. Vertical dovetail anchorage. Patented (Aluminium and brass version).

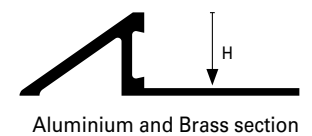
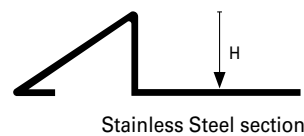

(ZR 100\*)

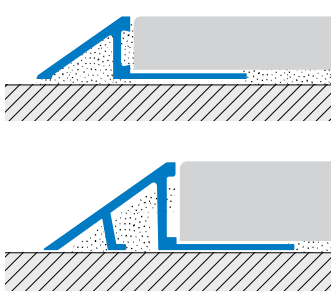

**ZEROTEC ZR-O\* Extruded Brass**

This brass profile is developed with prime choice raw material in order to guarantee the tolerance and endurance to chemical and mechanical solicitations. It is primarily applied on both indoor and outdoor floors and can bear intense transit areas as well as for detailing elegant residential coverings. Through contact with moisture or corrosive media, brass may oxidize on exposed surfaces. This situation can be easily solved by buffing the product with a conventional polisher to return to its original shine. Available in natural brass (ON) or polished brass (OL).

	H=mm		Art.	
Material:	8	ZR	80	ON/OL
Extruded Brass	10	ZR	100	ON/OL
Finish*: Natural (ON), Polished (OL)	12,5	ZR	125	ON/OL
	15	ZR	150	ON/OL
Length: 2,70 metres				
: 0,90 / 1,35 metres				

**ZEROTEC ZR-AN Natural aluminium**

This profile is developed in conformity with the UNI standards. It has little tolerance to mechanical or chemical solicitation. During installation, excess adhesive and grout should be removed immediately to avoid stains. The exposed surface may change color or darken in time. Outdoors or where higher stresses are involved the use of brass or stainless steel models are recommended.

Material:	8	ZR	80	AN
Extruded Aluminium	10	ZR	100	AN
Finish: Natural (AN)	12,5	ZR	125	AN
Length: 2,70 metres				
: 0,90 / 1,35 metres				

**ZEROTEC ZR-AS Silver Anodised Aluminium**

This profile has a silver coating and is suitable for both indoor or outdoor application with high tolerance to weather agents but less to mechanical impact. During installation, excess adhesive and grout should be removed immediately to avoid stains. The exposed surface may change colour or darken in time. Where higher stresses are involved the use of brass profiles is recommended.

Material:	8	ZR	80	AS
Extruded anodised aluminium	10	ZR	100	AS
Finish: Silver (AS)	12,5	ZR	125	AS
Length: 2,70 metres				
: 0,90 / 1,35 metres				

**ZEROTEC ZR-IL Stainless Steel - AISI 304 - DIN 1.4301**

This stainless steel profile AISI 304 standard ensures high tolerance to most of diluted chemicals found in laboratories or strong detergents present in food processing plants, commercial kitchens, slaughter houses, breweries, hospitals, public toilets etc.

Material:	8	ZR	80	IL
Stainless Steel AISI 304	10	ZR	100	IL
Finish: Polished (IL)	12,5	ZR	125	IL
	15	ZR	150	IL
Length: 2,70 metres				
: 0,90 / 1,35 metres				

: Pre-cut length available in SELFLINE kit L= 0,90/1,35 m

**CURVELINE**

Some profile of **ZEROTEC ZR** series are also available with a special cut flange so they become formable for curved edges and inlays. To order: add the letter D to the product code – for further details see page 47.





ramp+tec™ ZRR

**RAMPTEC ZRR** profile in anodised aluminium has been conceived to join floors at different heights.

The ramp angle of elevation of 20° allows to connect smoothly uneven adjoining floor levels for a safe transit.

The vertical edge has the dovetail internal cavity for a better mechanical fixing for both grout and adhesive, in the major intensive load points.

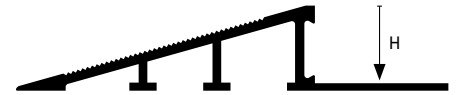

(ZRR 100\*)

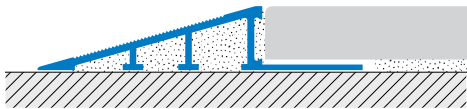

**RAMPTEC ZRR-AS Silver Anodised Aluminium**

This profile has a silver coating and is suitable for both indoor or outdoor application with high tolerance to weather agents. Profile suitable also for car transit.

	H=mm	Art.		
Material:	10	ZRR	100	AS
Extruded anodised aluminium	12,5	ZRR	125	AS
Finish: Silver (AS)	15	ZRR	150	AS
Length: 2,70 metres				





**LINETEC** profile is a joint profile for thin bed adhesive laying. It has to 5 mm visible face width at surface and a 4 mm thick body which allows grinding along with the floor covering material in installation. It is also ideal for marble or wood flooring combinations. The arrow shaped vertical flange of this profile ensures a solid mechanical bond within the split cavity.

linetec™ AD

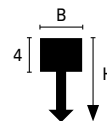

(AD 10\*)

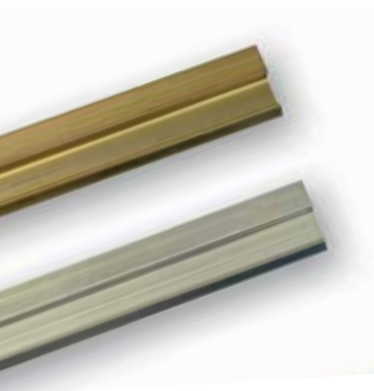

**LINETEC AD-ON Natural Brass**

This brass profile is developed with prime choice raw material in order to guarantee tolerance and endurance to chemical and mechanical solicitations. It is primarily applied on both indoor and outdoor floors and can bear intense transit areas as well as for detailing elegant residential coverings. Through contact with moisture or corrosive media, brass may oxidize on exposed surfaces. This situation can be easily solved by buffing the product with a conventional polisher to return to its original shine.

**LINETEC AD 10 AN Natural aluminium**

This profile is developed in conformity with the UNI standards. It has little tolerance to mechanical or chemical solicitation. During installation, excess adhesive and grout should be removed immediately to avoid stains. The exposed surface may change color or darken in time. Outdoors or where higher stresses are involved the use of brass profiles is recommended.

	<b>BxH</b>	<b>Art.</b>		
Material:	5x10	AD	10	ON
Extruded Brass	5x14	AD	14	ON
Finish: Natural (ON)				
Length: 2,70 metres				
Width: 5 mm				
Altezza: 10 mm e 14 mm				

Material:	5x10	AD	10	AN
Extruded Aluminium				
Finish: Natural (AN)				
Length: 2,70 metres				
Width: 5 mm				
Altezza: 10 mm				



**LINETEC MB** split joint profile is utilized for two joining floor coverings which are laid in traditional mortar bed. It is usually employed with marble coverings because it can bear grinding, yet still enhances the decorative effect. It is available in brass and aluminium in 5 and 10 mm widths which can bear grinding/polishing treatment during the laying process.

linetec™ MB

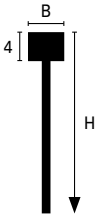

(MB 5\*)

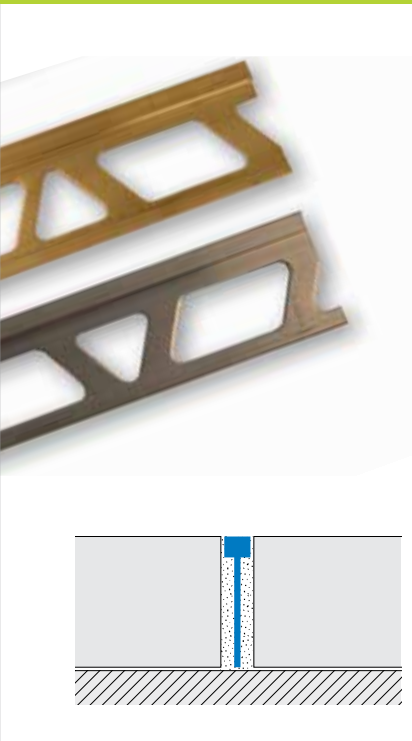

**LINETEC MB-ON Brass Natural**

This brass profile is developed with prime choice raw material in order to guarantee tolerance and endurance to chemical and mechanical solicitations. It is primarily applied on both indoor and outdoor floors and can bear intense transit areas as well as for detailing elegant residential coverings. Through contact with moisture or corrosive media, brass may oxidize on exposed surfaces. This situation can be easily solved by buffing the product with a conventional polisher to return to its original shine.

**LINETEC MB 5 AN Natural aluminium**

This profile is developed in conformity with UNI standards. It has little tolerance to mechanical or chemical solicitation. During installation excess adhesive and grout should be removed immediately to avoid stains. The exposed surface may change colour or darken in time. Outdoors or where higher stresses are involved the use of brass profiles is recommended.

	<b>BxH</b>	<b>Art.</b>		
Material:	5x25	MB	5	ON
Extruded Brass	10x25	MB	10	ON
Finish: Natural (ON)				
Length: 2,70 metres				
Width: 5 mm a 10 mm				

Material:	5x25	MB	5	AN
Extruded Aluminium				
Finish: Natural (AN)				
Length: 2,70 metres				
Width: 5 mm				



**LINETEC PT** profile is a separation joint for several floors available in different sizes. The face width at surface is 2,5 mm. It is quite flexible and adaptable to decorative contour design laying, whether it be marble or palladiana terrazzo floors laid on cement or resin based screeds. This article can bear grinding/polishing treatment during the laying process.

linetec™ PT

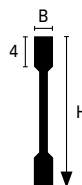

Brass section



Stainless Steel section

(PT 200\*)

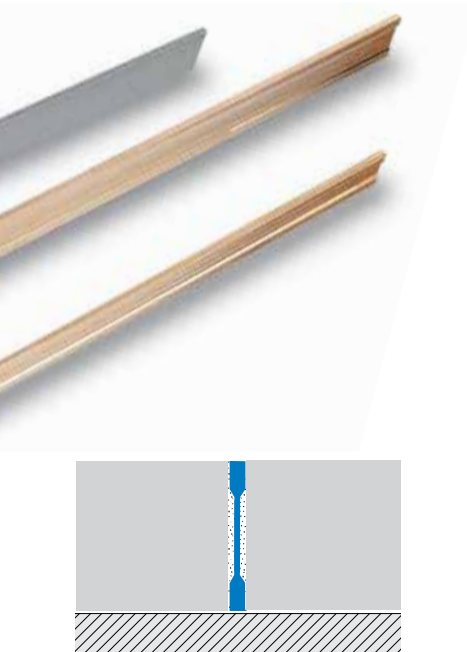

**LINETEC PT-ON Natural Brass**

This brass profile is developed with prime choice raw material in order to guarantee tolerance and endurance to chemical and mechanical solicitations. It is primarily applied on both indoor and outdoor floors and can bear intense transit areas as well as for detailing elegant residential coverings. Through contact with moisture or corrosive media, brass may oxidize on exposed surfaces. This situation can be easily solved by buffing the product with a conventional polisher to return to its original shine.

**LINETEC PT-IN Natural Stainless Steel AISI 304 - DIN 1.4301**

This stainless steel profile is AISI 304 standard which ensures high tolerance to most of diluted chemicals found in laboratories or strong detergents present in food processing plants, commercial kitchens, slaughter houses, breweries, hospitals, public toilets etc. The profile has a slight difference in shape compared to the brass one, due to the steel bending process.

	BxH		Art.	
Material:	2,5x10	PT	100	ON
Extruded Brass	2,5x15	PT	150	ON
Finish: Natural (ON)	2,5x20	PT	200	ON
	2,5x40	PT	400	ON
	5,0x30	PT	305	ON
Length: 2,70 metres				
Improved anchoring on the vertical side				

Material:	2,5x10	PT	100	IN
Stainless Steel AISI 304	2,5x15	PT	150	IN
Finish: Natural (IN)	2,5x20	PT	200	IN
	2,5x40	PT	400	IN
Length: 2,70 metres				





Formable trim profiles to bend into shape in order to follow floor contours and other particular geometrescal cuts thanks to to softer alloy and special flange sections.

They can be easily and quickly bent saving considerable time on site. Perfect for mosaic works or wood/ceramic combination flooring as well as for framing and edging resin floors laid on site, as they perfectly adapt to more elaborate decorative laying, allowing to create original inlays. The profiles can be formed with a simple hand pressure or employing the special bending equipment.

Laying instructions:

- Cut the profile to the desired length
- Manually curve the profile to the desired shape.
  - Where necessary use a template or the bending equipment.
- Anchor the profile to the support and if required fasten it with the screws that fit into the holes of the flange section.

The articles available with formable flange are listed here on the right, with the relevant minimum allowed radius, which can be achieved with the bending equipment.

# curveline™



Page	Available Series	Min. Int. Radius	Min. Ext. Radius
31	TR-ON / AS / AN / IL/IS	30 cm	30 cm
32	SR-ON / AS / IL/IS	50 cm	50 cm
42	ZR - A*	60 cm	-
42	ZR - ON	200 cm	-
49	SP 14 OL / AS	80 cm	80 cm
49	SP 14 OC	100 cm	100 cm



**COVERTEC SP** is a profile designed to join two adjacent existing floors at the same height but it can cover imperfections in cutting or slight variations of height to be found on a tiled floor joining to a wooden one for example. Thanks to its shape, available in 3 different widths, this profile helps floor coverings to maintain the minimum distance thus acting also as a dilatation joint.

covertec™ SP

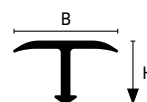

Aluminium and Brass section

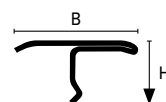

Stainless Steel section

(SP 14\*)

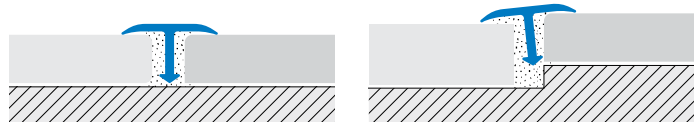

**COVERTEC SP** edges are slightly bent downwards in a rounded-off shape in order to help hide the difference of level up to 2 mm. The arrow head shaped vertical flange can be easily embedded into the gap but it is recommended not to use acetic based silicon for fixing, as brass can oxidize over time. Some versions of series **COVERTEC SP**, thanks to their particular alloy composition, can easily be bent manually in phase of laying to follow into the round contour cuts of flooring curvature decorative design jobs and curves. For further details verify the table at p. 47.





The gap between the two adjacent floors allows for final polishing treatments of wooden or marble surface without damaging the bordering one.

Profiles work as dilatation joint covers, while providing a proper finishing to possible cut or match imperfections between the two floors, as typical in the diagonal patterns.



#### COVERTEC SP-OL Polished Brass

This brass profile is developed with prime choice raw material in order to guarantee the tolerance and endurance to chemical and mechanical solicitations.

	BxH	Art.		
Material:	14x7	SP	14	OL
Extruded Brass	20x7	SP	20	OL
Finish: Polished (OL)	26x7	SP	26	OL
Length: 2,70 metres				
⚠: 0,90/1,35 metres				
Width: 14, 20, 26 mm				

#### COVERTEC SP-OC Chromed Brass

This profile has a chrome finish which conveys a higher aesthetic touch. It is water proof and resistant to most corrosive agents. Limited tolerance to abrasion, not recommended for high traffic areas.

Material:	14x7	SP	14	OC
Extruded Brass	20x7	SP	20	OC
Finish: Chrome (OC)				
Length: 2,70 metres				
Width: 14, 20 mm				

#### COVERTEC SP-I\* Stainless Steel AISI 304 - DIN 1.4301

Patented system in stainless steel. It ensures an excellent resistance to corrosion. The profile has a slight difference in shape compared to the brass one due to the special steel rolling process which differs from the brass work process. Available in polished stainless steel (IL), brushed (IS) or sanded (IX).

Material:	14x7	SP	14	IL/IS/IX
Stainless Steel AISI 304	20x7	SP	20	IL/IS/IX
Finish*: Polished (IL), Brushed (IS), Sanded (IX)				
Length: 2,70 metres				
⚠: 0,90/1,35 m - only (IL)				
Width: 14, 20 mm				

#### COVERTEC SP-AS Silver Anodised Aluminium

This profile has a silver coating and is suitable for both indoor or outdoor application with high tolerance to weather agents but less to mechanical impact. During installation excess adhesive and grout should be removed immediately to avoid stains. The exposed surface may change colour or darken in time. Where higher stresses are involved the use of brass profiles is recommended.

Material:	14x7	SP	14	AS
Extruded anodised aluminium	20x7	SP	20	AS
Finish: Silver (AS)				
Length: 2,70 metres				
⚠: 0,90/1,35 metres				
Width: 14, 20 mm				

#### COVERTEC SP\* Aluminium Wood Cladding Finish

Profile with a melamine wood tone in 8 different varieties. Good tolerance to abrasion comparable to most melamine coverings. The melamine embossing on the aluminium is particularly smooth therefore it remains quite clean and blends well with the flooring tone.

	Finish	L=14 mm		L=20 mm			
Material:	Whitened	SP	14	RS	SP	20	RS
Extruded Aluminium Laminate cov.	Maple	SP	14	AC	SP	20	AC
Length: 2,70 metres	Beech	SP	14	FA	SP	20	FA
⚠: 0,90/1,35 metres	Oak	SP	14	RO	SP	20	RO
Width: 14, 20 mm	Cherry	SP	14	CI	SP	20	CI
	Light walnut	SP	14	NC	SP	20	NC
	Dark walnut	SP	14	NS	SP	20	NS
	Wengé	SP	14	WE	SP	20	WE

⚠: Pre-cut length available in SELFLINE kit L= 0,90/1,35 m





# strip<sup>+</sup>tec™ ST

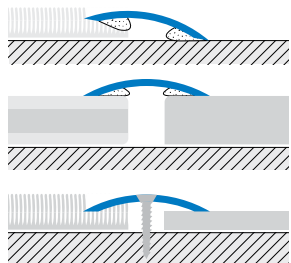

### Installation for self-adhesive version:

- 1) Check if support is sound, smooth, clean, dry and free from grease and loose materials.
- 2) Cut profile to the required length and remove the protective film.
- 3) Press downwards on the profile until it is fixed firmly. Do not hammer.

### Installation for pre-drilled version:

- 1) Cut profile to the required length and place the mark on the surface of the profile pre-drilled holes.
- 2) Insert and fix the flare head screws.

**STRIPTEC** profile is generally fixed to link two adjacent floors of similar or different height and covering materials. The rounded shape of this strip profile grants to maximum height difference of 5 mm. To apply STRIPTEC means also to cover up the slight imperfections which may occur during the laying job. It can also be used as a terminal profile provided that the thickness of the surface material does not exceed 5 mm.

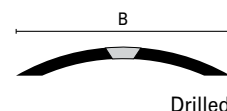
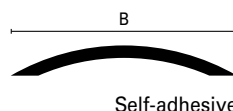

### STRIPTEC ST-OL\* Brass polished

A laminate polished brass flat bar which is resistant to light mechanical and chemical impacts and lasting wear. The brass article allows an extremely elegant decorative finish to homes and is available in pre-drilled or self adhesive versions.

Available also in the heavy duty version, thickness 1,3 mm, Code STP 30 OLA/OLF.

	B=mm	Art.	Adhesive	Drilled	Not drill.
Material:	18	ST 18	OLA	-	OLN
Laminated Brass	30	ST 30	OLA	OLF	
Finish: Polished (OL*)	35	ST 35	OLA	OLF	
Length: 2,70 metres					
△: 0,90 / 1,35 metres					
Width: 18, 30, 35 mm					

### STRIPTEC ST-IL\* Polished Stainless Steel

Stainless steel profile with a high resistance to wear and a good resistance to atmospheric agents.

Available in self-adhesive (OLA), drilled (OLF), pre-drilled (OLN) versions.

	B=mm	Art.	Adhesive	Drilled	Not drill.
Material:	18	ST 18	ILA	-	ILN
Stainless Steel	30	ST 30	ILA	ILF	
Finish: Polished (IL*)	35	ST 35	ILA	ILF	
Length: 2,70 metres					
△: 0,90 / 1,35 metres					
Width: 18, 30, 35 mm					

### STRIPTEC ST-A\* Anodised Aluminium

Full aluminium anodised profile available in Silver (AS), Gold (AO), Bronze (AB) finishes. This product confers to chromatic combination with indoor decoration with all floor covering materials.

	B=mm	Art.	Adhesive	Drilled	Not drill.
Material:	18	ST 18	A*A	A*F	
Extruded anodised aluminium	30	ST 30	A*A	A*F	
Finish*: Silver (AS*), Gold (AO*), Bronze (AB*)	35	ST 35	A*A	A*F	
	40	ST 40	A*A	A*F	
Length: 2,70 metres					
△: 0,90 / 1,35 metres					
Width: 18, 30, 35, 40 mm					

### STRIPTEC ST 30\* Aluminium Wood Cladding Finish

Profile with to melamine wood tone in 8 different varieties. Good tolerance to abrasion comparable to most melamine coverings.

The melamine embossing on the aluminium is particularly smooth therefore it remains quite clean and blends well with the flooring tone.

	Finish	Adhesive	Drilled
Material:	Whitened	ST 30 RSA	ST 30 RSF
Extruded Aluminium Laminate cov.	Maple	ST 30 ACA	ST 30 ACF
	Beech	ST 30 FAA	ST 30 FAF
Length: 2,70 metres	Oak	ST 30 ROA	ST 30 ROF
	Cherry	ST 30 CIA	ST 30 CIF
Width: 30 mm	Light walnut	ST 30 NCA	ST 30 NCF
	Dark walnut	ST 30 NSA	ST 30 NSF
	Wengé	ST 30 WEA	ST 30 WEF

△: Pre-cut length available in SELFLINE kit L= 0,90/1,35 m





A wide choice of transition and threshold strip profiles with a variety of widths and top detailing such as knurling, rounded edges or simply flat and/or heavier bars for better fitting under doorways. This variety is to best customize residential finishing and adapt to any decorative environment. The extruded brass and aluminium models are suitable for heavier transit areas.

# strip+tec™ ST/SB



## STRIPTEC ST 38 A\* Anodised Aluminium

A top knurled bar in silver color finish, gold or bronze. High tolerance to corrosion but limited resistance to mechanical impact. The mid-section thickness is 3,7 mm. Self-adhesive (A\*A), Drilled (A\*F) version.



	B=mm	Art.		Adhesive	Drilled
Material: Extruded anodised aluminium	38	ST	38	ASA	ASF
Finish*: Silver (AS*), Gold (AO*), Bron. (AB*)	38	ST	38	AOA	AOF
	38	ST	38	ABA	ABF
Length: 2,70 metres					
: 0,90/1,35 metres					

## STRIPTEC STB-OL\* Polished Brass

The brass article ensures an excellent tolerance to impact and chemical environments. Therefore it is ideal for industrial or commercial areas where heavier transit occurs. Also suitable in residential areas where brass is always appreciated. The mid-section thickness is 1,5 mm. Self-adhesive (A\*A), Drilled (A\*F) version.

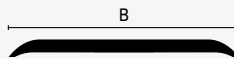

Material: Extruded Brass	30	STB	30	OLA	OLF
	35	STB	35	OLA	OLF
	40	STB	40	OLA	OLF
Finish: Polished (OL*)					
Length: 2,70 metres					
: 0,90/1,35 metres					

## STRIPTEC ST 50 OL\* Polished Brass

A heavy cambered brass profile with 5 mm, thickness mid-section. Designed to guarantee resistance to chemical and mechanical impact present in commercial or industrial areas with heavier transit. Self-adhesive (A\*A), Drilled (A\*F) version.

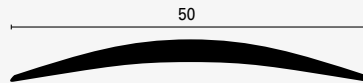

Material: Extruded Brass	50	ST	50	OLA	OLF
Finish: Polished (OL*)					
Length: 2,70 metres					

## STRIPTEC STB 25 A\* Anodised aluminium

This top grooved flat head profile has a silver, gold or bronze coating. Good anti-oxidation tolerance but less to mechanical impact. Mid-section thickness: 2,2 mm. Self-adhesive (A\*A), Drilled (A\*F) version.

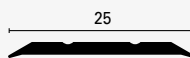

Material: Extruded anodised aluminium	25	STB	25	ASA	ASF
	25	STB	25	AOA	AOF
	25	STB	25	ABA	ABF
Finish*: Silver (AS*), Gold (AO*), Bron. (AB*)					
Length: 2,70 metres					
: 0,90/1,35 metres					

## STRIPTEC STB 35 A\* Anodised aluminium

This flat head aluminium smooth heavy duty aluminium profile is coloured finished in silver, gold or bronze. The pre-drilled version has its holes placed in the middle. One may opt for the side holes for the code L version. The mid-section thickness is 2,4 mm. Self-adhesive (A\*A), Drilled (A\*F) version.

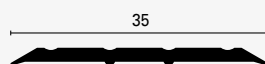

Material: Extruded anodised aluminium	35	STB	35	ASA	ASF
	35	STB	35	AOA	AOF
	35	STB	35	ABA	ABF
Finish*: Silver (AS*), Gold (AO*), Bron. (AB*)					
Length: 2,70 metres					
: 0,90/1,35 metres					

: Pre-cut length available in SELFLINE kit L= 0,90/1,35 m



**LEVELTEC RP** is conceived as terminal and joining profile for floors at different heights. This product can also cover slight imperfections due to cuts or chipping of different materials such as wood floors joining to linoleum or carpeting. LEVELTEC RP series comprises different height adjustments ranging from a

4,5 ÷ 12,5 mm scale and to 3 ÷ 14 mm mismatch. The product is usually sold with a ready to fix high quality self-adhesive for DIY installation. Available also in the pre-drilled version, to be fixed with screws and dowels.

## leveltec™ RP

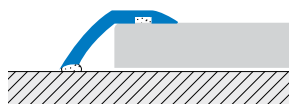

### Installation for self-adhesive version:

- 1) Check if support is sound, smooth, clean, dry and free from grease and loose materials.
- 2) Cut profile to the required length and remove the protective film.
- 3) Apply the profile by pressing on it until it is firmly fixed – do not hammer.

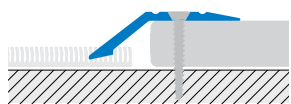

### Installation for pre-drilled version:

- 1) Cut profile to the required length and remove the protective film.
- 2) Insert and fix the flare head screws



### LEVELTEC RP-OL\* Polished Brass

This profile is adaptable to various heights of connecting floors thanks to the availability of four different models. This profile is supplied with a polished surface.

The profile RPR 39, thanks to its reversible form can be used on both sides, joining heights from 8 to 14 mm. Self-adhesive (A\*A), Drilled (A\*F) version.

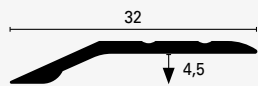

	HxB	Art.		Adhesive	Drilled
Material: Extruded Brass	4,5x32	RP	50	OLA	OLF
Finish: Polished (OL*)					
Length: 2,70 metres					
: 0,90 / 1,35 metres					

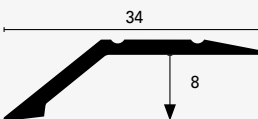

	HxB	Art.		Adhesive	Drilled
Material: Extruded Brass	8x34	RP	80	OLA	OLF
Finish: Polished (OL*)					
Length: 2,70 metres					
: 0,90 / 1,35 metres					

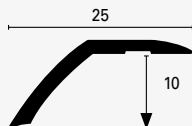

	HxB	Art.		Adhesive	Drilled
Material: Extruded Brass	10x25	RP	100	OLA	OLF
Finish: Polished (OL*)					
Length: 2,70 metres					
: 0,90 / 1,35 metres					

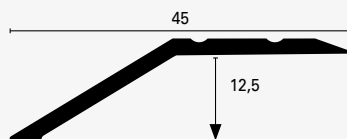

	HxB	Art.		Adhesive	Drilled
Material: Extruded Brass	12,5x45	RP	125	OLA	OLF
Finish: Polished (OL*)					
Length: 2,70 metres					
: 0,90 / 1,35 metres					

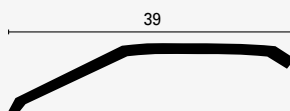

	HxB	Art.		Adhesive	Drilled
Material: Extruded Brass	39	RPR	39	OLA	OLN
Finish: Polished (OL*)					
Length: 2,70 metres					
: 0,90 / 1,35 metres					

: Pre-cut length available in SELFLINE kit L= 0,90/1,35 m

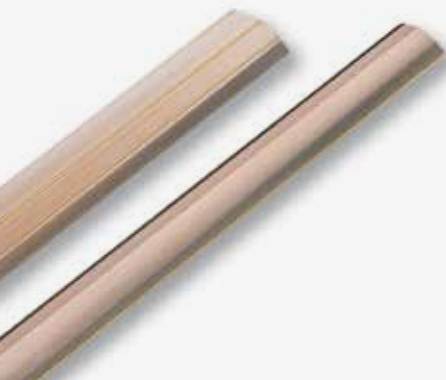



Available in different widths and heights to meet all possible needs of junction between floors at different levels, with smooth or grooved surface. Their thickness makes them suitable also for environments with high pedestrian traffic. Their shaped edges ensure a perfect contact between the profile and the floor.

# leveltec™ RP

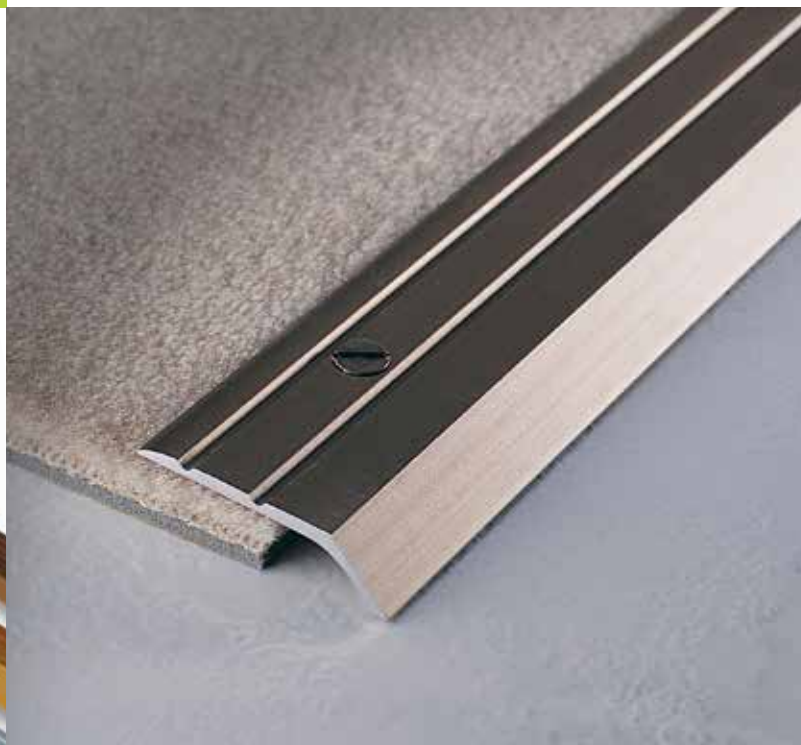
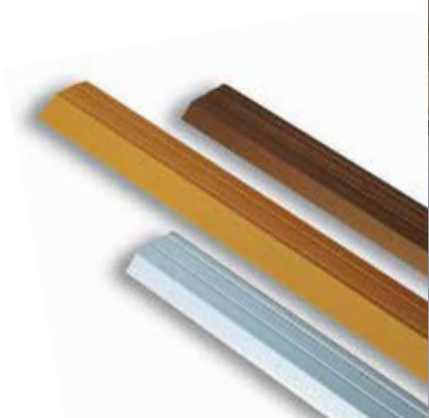
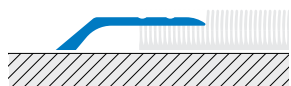

## LEVELTEC RP 50 A\* Anodised aluminium

This aluminium version is available in three different colour finishes: Silver (AS\*), Gold (AO\*), Bronze (AB\*) and it blends well with several flooring materials utilized in domestic environments.  
Self-adhesive (A\*A), Drilled (A\*F) version.

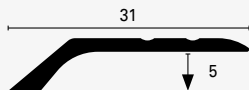

	HxB	RP	Art.	Adhesive	Drilled
Material:	5x31	RP	50	ASA	ASF
Extruded anodised aluminium	5x31	RP	50	AOA	AOF
	5x31	RP	50	ABA	ABF
Finish*: Silver (AS*), Gold (AO*), Bron. (AB*)					
Length:	2,70 metres				

## LEVELTEC RP 80 A\* Anodised aluminium

This top grooved aluminium version is available in three different colour finishes: Silver (AS\*), Gold (AO\*), Bronze (AB\*) and it blends well with several flooring materials utilized in domestic environments.  
Self-adhesive (A\*A), Drilled (A\*F) version..

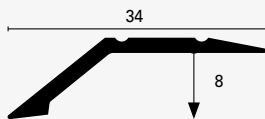

	HxB	RP	Art.	Adhesive	Drilled
Material:	8x34	RP	80	ASA	ASF
Extruded anodised aluminium	8x34	RP	80	AOA	AOF
	8x34	RP	80	ABA	ABF
Finish*: Silver (AS*), Gold (AO*), Bron. (AB*)					
Length:	2,70 metres				

## LEVELTEC RP-IL\* Polished Stainless Steel

Stainless steel profile with a high resistance to wear and to good resistance to atmospheric agents.  
Self-adhesive (ILA), Drilled (ILF) version.

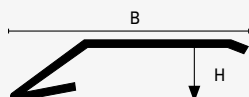

	HxB	RP	Art.	Adhesive	Drilled
Material:	5x29	RP	50	ILA	ILF
Stainless Steel	8x34	RP	80	ILA	ILF
	11x38	RP	110	ILA	ILF
Finish: Polished (IL*)					
Length:	2,70 metres				



This type of profile represents our innovative program for transition and finishing profiles for adjacent floor coverings with different levels. Due to its very special design, VARIOTEC DC features a multi-height adaptability which can range from 7 mm to 14 mm by simple inclination. This type of profile is to be glued on existing floors or as finish terminal floor edging to portray an extremely elegant touch. For gluing application we recommend to use our special adhesive.

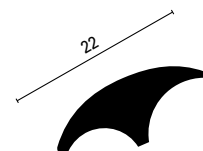

variotec™ DC

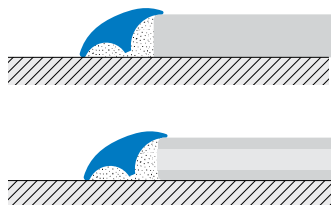

**VARIOTEC DC 22 OL Polished Brass**

Full brass profile to guarantee the tolerance and endurance to chemical and mechanical solicitations. Through the contact of moisture or corrosive media, brass may oxidize on the exposed surfaces. This situation can be easily solved by buffing the product with a conventional polisher to return to its original shine.

	B=mm		Art.	
Material: Extruded Brass	22	DC	22	OL
Finish: Polished (OL)				
Length: 2,70 metres				

**VARIOTEC DC 22 A\* Anodised aluminium**

This aluminium version is available in three different colour finishes: Silver (AS), Gold (AO), Bronze (AB) and it blends well with several flooring materials utilized in domestic environments

Material: Extruded anodised aluminium	22	DC	22	AS/AO/AB
Finish*: Silver (AS), Gold (AO), Bronze (AB)				
Length: 2,70 metres				





**VARIOTEC DK** is a product specially conceived for domestic and light commercial use. The different coloured versions contribute to an outstanding decorative finishing. It is supplied with a special high quality elastomer adhesive for easier application and can compensate floor coverings with height differences between 7 and 16 mm. Simply apply pressure by hand on the profile to fix to the dry floor and make sure that the surface to cover is free from any dirt or grease.

variotec™ DK

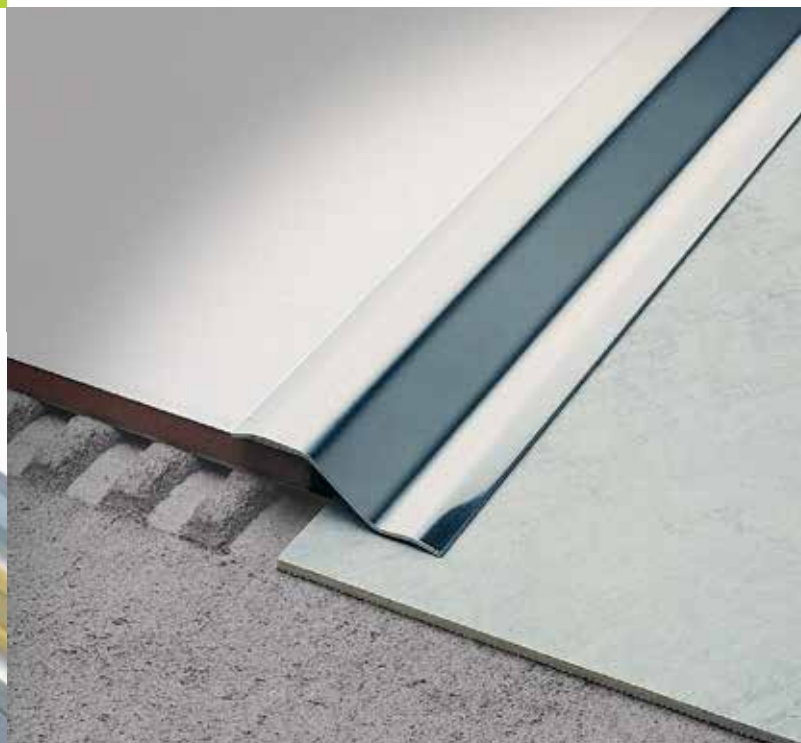
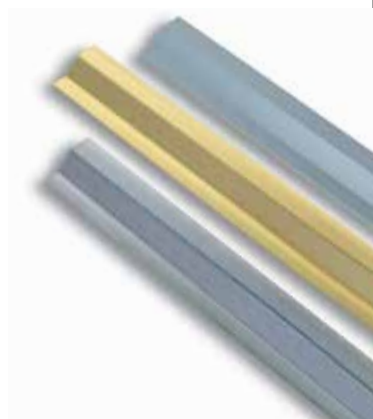
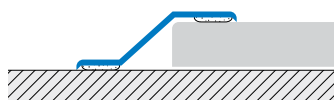
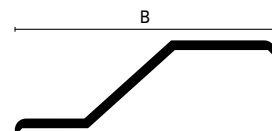

**VARIOTEC DK 37 A\*A Anodised Aluminium (with adhesive)**

Mostly used in domestic environments or commercial areas with limited transit. Its variety of colour finishes makes it quite pleasing to the eye.

	B=mm		Art.	
Material: Extruded anodised aluminium	37	DK	37	A*A
Finish*: Silver (ASA), Gold (AOA), Bronze (ABA)				
Length: 2,70 metres				
⚠: 0,90 / 1,35 metres				

**VARIOTEC DK-OLA Polished Brass (with adhesive)**

Highly aesthetic transition profile, granting good performances against wear and tear.

Material: Laminated Brass	37 47	DK DK	37 47	OLA OLA
Finish: Polished (OLA)				
Length: 2,70 metres				
⚠: 0,90 / 1,35 metres				

**VARIOTEC DK-ILA Polished Stainless Steel (with adhesive)**

Stainless steel profile with a high resistance to wear and a good resistance to atmospheric agents.

Material: Stainless Steel	37 47	DK DK	37 47	ILA ILA
Finish: Polished (ILA)				
Length: 2,70 metres				
⚠: 0,90 / 1,35 metres				

⚠: Pre-cut length available in SELFLINE kit L= 0,90/1,35 m



**VARIOTEC** range comprises a wide choice of many other versatile edgings, to best shop fit and protect many different flooring materials or fit onto existing floors. It is highly suitable for connecting ceramic or wood floorings to lower thinner coverings, such as vinyl or carpet.

**vario+tec™**

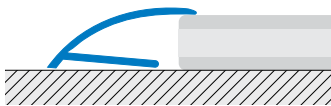
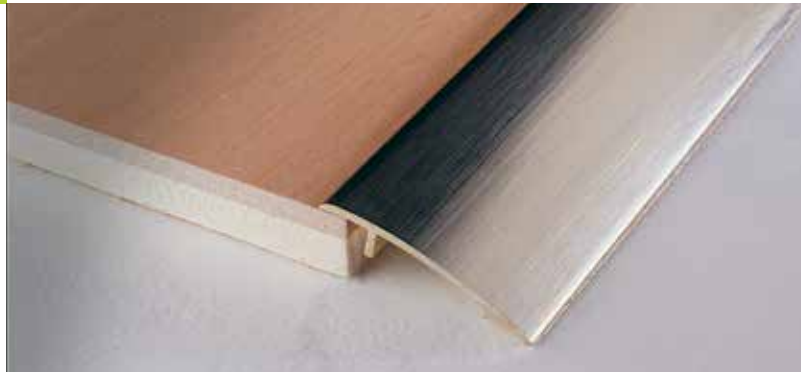

**VARIOTEC DR 36 OLA Polished Brass (with adhesive)**

Slope edge rotating profile in solid brass resistant to abrasion, chemical and mechanical impact.

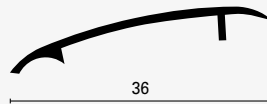

	<b>B=mm</b>	<b>Art.</b>		
Material: Extruded Brass	36	DR	36	OLA
Finish: Polished (OL)				
Length: 2,70 metres				
0,90/1,35 metres				

**VARIOTEC DR 36A\*A Anodised Aluminium (with adhesive)**

Slope edge rotating aluminium profile available in three different colour finishes: Silver, Gold, Bronze ensuring to good colours matching with all kinds of floor coverings. Indicated for domestic applications.

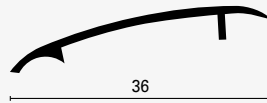

Material: Extruded anodised aluminium	36 36 36	DR DR DR	36 36 36	ASA AOA ABA
Finish*: Silver (AS), Gold (AO), Bronze (AB)				
Length: 2,70 metres				

**VARIOTEC DS 27\* Polished Brass - Polished Stainless Steel (with adhesive)**

Flattening profile for 7 ÷ 12 mm height compensation. Comes in Brass or Stainless Steel with self adhesive strips with excellent hold.

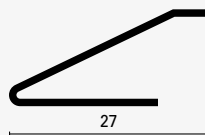

Material: Laminated Brass Stainless Steel	27 27	DS DS	27 27	OLA ILA
Finish: Polished (LA)				
Length: 2,70 metres				
0,90/1,35 metres				

**VARIOTEC LS 30 A\*A Anodised Aluminium (with adhesive)**

Flattening profile for 7 ÷ 13 mm height compensation. Comes with adhesive glue strips with excellent hold



Material: Extruded anodised aluminium	30 30 30	LS LS LS	30 30 30	ASA AOA ABA
Finish*: Silver (AS), Gold (AO), Bronze (AB)				
Length: 2,70 metres				

Pre-cut length available in SELFLINE kit L= 0,90/1,35 m



A selection of full brass extruded profile shapes for existing floor edges and/or junctions with a 10 mm drop level to connect to flooring materials or fit onto pre-laid floors. It is highly suitable for rapidly connecting differing floors such as ceramic to wood or other combinations and wherever adjoining profile has not been planned during the laying job.

leveltec™  
linetec™

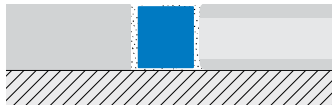

**LEVELTEC ZP 100 OL Polished Brass**

Extruded brass profile for pre-laid floor edges and terminal with dovetail internal flange fitting.

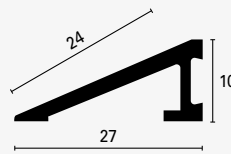

	BxH	Art.		
Material: Extruded Brass	27x10	ZP	100	OL
Finish: Polished (OL)				
Length: 2,70 metres				

**LINETEC PR 10 OL Polished Brass**

A full solid brass profile with a rounded-off section, designed for elegant terminal edge finish with either wood or tile floors.

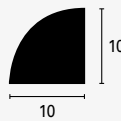

Material: Extruded Brass	10x10	PR	10	OL
Finish: Polished (OL)				
Length: 2,70 metres				

**LINETEC PQ 10\* Natural Brass - Stainless Steel**

Full cube shaped solid brass profile: decorative separation or terminal edge finish. It can bear floor grinding, allowing one to work on the edge of the wooden floor without damaging the bordering ceramic.

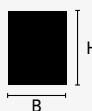

Material: Extruded Brass Stainless Steel AISI 304	8x10 10x10	PQ PQ	10 10	ON IN
Finish: Natural (*N)				
Length: 2,70 metres				

**LINETEC PU 10 OL Polished Brass**

Hollow section "reverse U" profile very suitable for decorative separation between wood parquet and ceramic floors. The hollow cavity allows the glue to optimize its grip action.

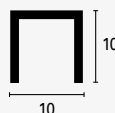

Material: Extruded Brass	10x10	PU	10	OL
Finish: Polished (OL)				
Length: 2,70 metres				



multiclip®

**MULTICLIP®** is a system conceived to solve the problems associated with wooden floors. Especially laminate flooring systems.

It consists of a base section, one or more synthetic resin fixing clips to suit the depth of the flooring material and a wide range of finishing top strips. It is a true multipurpose and economical system that solves different problems using the minimum number of components.

Available in 8 popular wooden shades, anodised aluminium and solid brass. **MULTICLIP®** system, patented.

**MULTIFIX alternative fixing system with dowels.**

Along with the track base and "clip" professional application one may utilize the dowel MULTIFIX fixed in drilled holes for a paving with less intense transit.

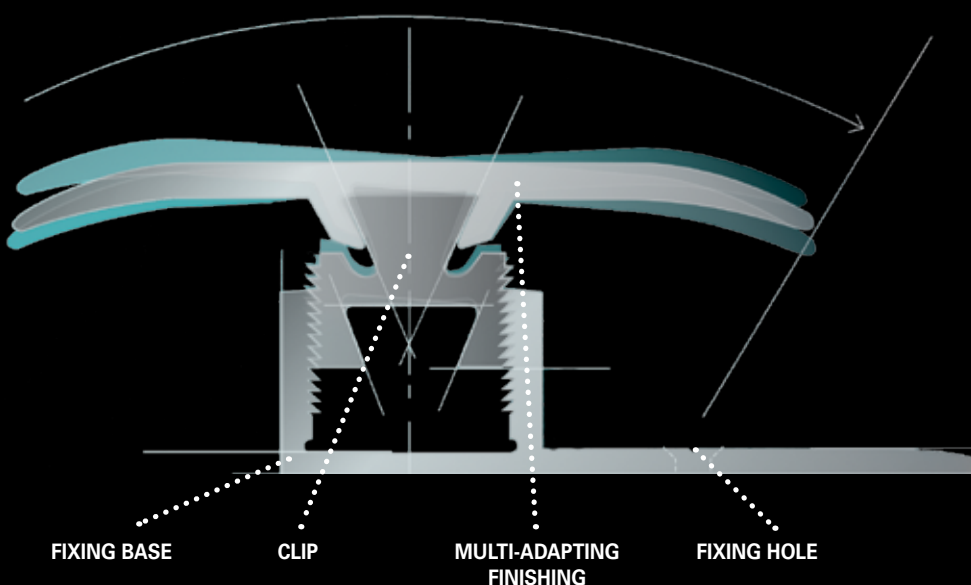

**MULTICLIP® system consists of:**

- A range of finishing profiles of different shapes, colours and materials.
- to base section (drilled or perforated flanged) underlying track that can be fixed in place either with adhesives or mechanically using plugs and screws.
- Special "clips" to allow the jointing of different heights of floor covering as required.

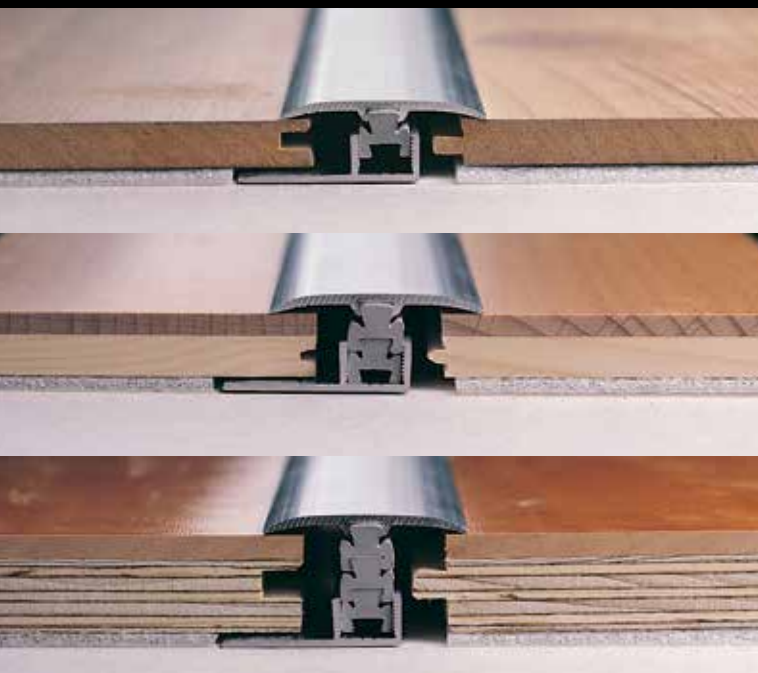

Use one clip to join height difference ranging from 6 ÷ 10 mm

Use two clips for height difference ranging from 11 ÷ 15 mm

Use three clips for height difference ranging from 16 ÷ 20 mm





# multiclip® CLG 370

This clip system joining profile for matching floors can also compensate slight differences in height, up to 3 mm. The modular concept provides you with the possibility to adjust to other paving, matching all thicknesses using one or more clips. Thanks to the 16 mm space left empty underneath, **MULTICLIP®** profile works also as an expansion joint allowing for to ± 5 mm movement of the wood covering. As a matter of fact the general dampness or humidity factors are calculated to act 0,5 mm on dilatation per linear meter of bay on double-layer laminated wood flooring.

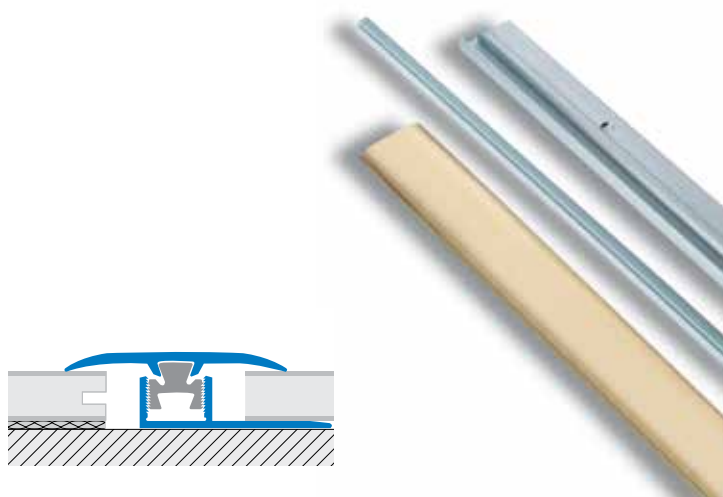
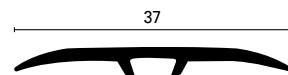

### MULTICLIP® CLG 370 A\* Anodised aluminium

Aluminium profile with a anodising coating in Silver, Gold or Bronze finish. The profile is adaptable to several floor coverings thanks to its versatility characteristics.

Mounts with Clip CL 80 P + Aluminium base CLB 80 ANF/ANT.

### MULTICLIP® CLG 370\* Aluminium Wood Cladding Finish

Profile with to melamine wood tone in 8 different varieties. Good tolerance to abrasion comparable to most melamine coverings. The melamine embossing on the aluminium is particularly smooth therefore it remains quite clean and blends well with the flooring tone.

Mounts with Clip CL 80 P + aluminium base CLB 80 ANF / ANT.

### MULTICLIP® CLG 370 OL Polished Brass

Innovative: the new modular system Multiclip® allows to use also the traditional brass finishing profiles, as the clips in Resinil avoid binding. Solid polished brass for to lasting classic finish and to very good resistance to mechanical impacts.

Mounts with Clip CL 80 P + aluminium base CLB 80 ANF / ANT.

	Art.		Finish
Material:	CLG 370	AS	Silver
Extruded anodised aluminium	CLG 370	AO	Gold
Length: 2,70 metres	CLG 370	AB	Bronze
: 0,90 / 1,35 metres			

Material:	CLG 370	RS	Whitened
Extruded Aluminium Laminate cov.	CLG 370	AC	Maple
Length: 2,70 metres	CLG 370	FA	Beech
: 0,90 / 1,35 metres	CLG 370	RO	Oak
	CLG 370	CI	Cherry
	CLG 370	NC	Light walnut
	CLG 370	NS	Dark walnut
	CLG 370	WE	Wengé

Material:	CLG 370	OL	Polished Brass
Extruded Brass			
Length: 2,70 metres			
: 0,90 / 1,35 metres			

: Pre-cut length available in SELFLINE kit L= 0,90/1,35 m



# multiclip® CLF 450

Joining terminal profile for mismatching floors ranging between 6 ÷ 11 mm. **MULTICLIP®** components fit perfectly together thanks to the clip in technopolymer, without binding and rattling. The multi groove cut clip insert allows the top profile to be pressed and interlocked with the base unit, while a slight swivel pivot action is allowed in order to follow the solicitations, especially on floating floors, and to match the two floor surfaces perfectly.

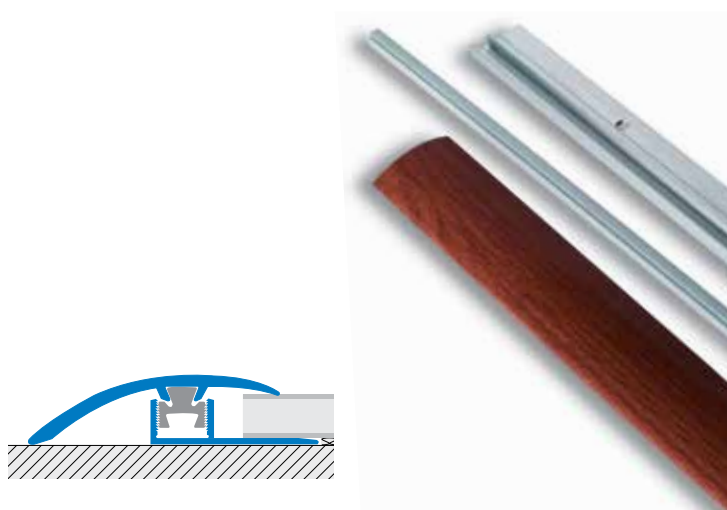
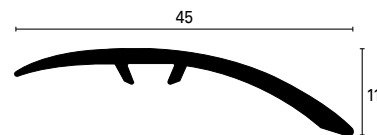

### MULTICLIP® CLF 450 A\* Anodised aluminium

The profile is anodised aluminium with a Silver, Gold or Bronze colour finish. The profile is adaptable to several coverings and floor levels thanks to its versatility characteristics.

Mounts with Clip CL 80 P + aluminium base CLB 80 ANF / ANT.

	Art.		Finish
Material:	CLF 450	AS	Silver
Extruded anodised aluminium	CLF 450	AO	Gold
Length: 2,70 metres	CLF 450	AB	Bronze
0,90 / 1,35 metres			

### MULTICLIP® CLF 450\* Aluminium Wood Cladding Finish

Profile with a melamine wood tone in 8 different varieties. High tolerance to abrasion comparable to most melamine coverings. The melamine embossing on the aluminium is particularly smooth therefore it remains quite clean and blends well with the flooring tone.

Mounts with Clip CL 80 P + aluminium base CLB 80 ANF / ANT.

Material:	CLF 450	RS	Whitened
Extruded Aluminium Laminate cov.	CLF 450	AC	Maple
Length: 2,70 metres	CLF 450	FA	Beech
0,90 / 1,35 metres	CLF 450	RO	Oak
	CLF 450	CI	Cherry
	CLF 450	NC	Light walnut
	CLF 450	NS	Dark walnut
	CLF 450	WE	Wengé

### MULTICLIP® CLF 450 OL Polished Brass

Innovative: the new modular system Multiclip® allows to use also the traditional brass finishing profiles, as the clips in Resinil avoid binding. Solid polished brass for a lasting classic finish and a very good resistance to mechanical impacts.

Mounts with Clip CL 80 P + aluminium base CLB 80 ANF / ANT.

Material:	CLF 450	OL	Polished Brass
Extruded Brass			
Length: 2,70 metres			
0,90 / 1,35 metres			

Pre-cut length available in SELFLINE kit L= 0,90/1,35 m



# multiclip® CLF 490

Joining terminal profile for mismatching floors ranging between 12 ÷ 18 mm and over. To be used with at least two fixing clips. This terminal profile allows an easy junction between ceramic or parquet floors and existing surfaces or with carpet or vinyl lower coverings. The multi groove cut clip insert allows the top profile to be pressed and interlocked with the base unit, while a slight swivel pivot action is allowed in order to follow the solicitations, especially on floating floors, and to match the two floor surfaces perfectly.

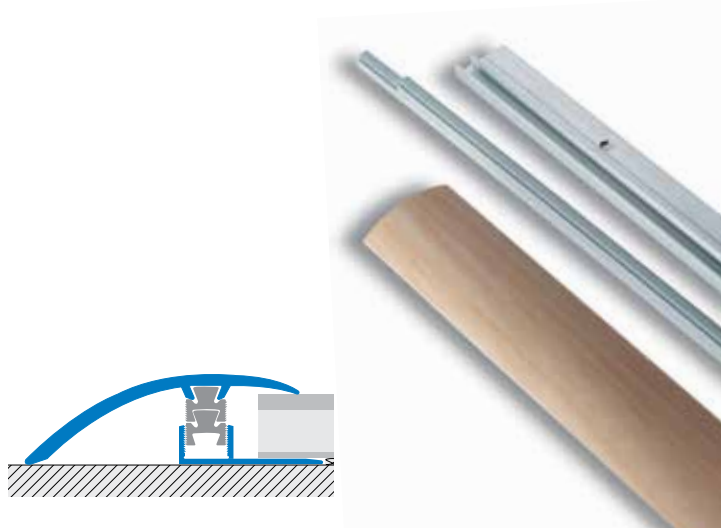
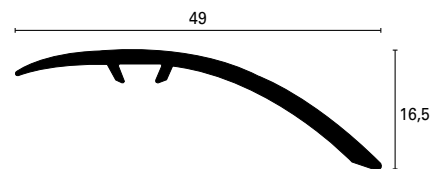

### MULTICLIP® CLF 490 A\* Anodised aluminium

The profile is anodised aluminium with a Silver, Gold or Bronze colour finish. The profile is adaptable to several coverings thanks to its versatility characteristics.

Mounts with Clip CL 80 P + aluminium base CLB 80 ANF / ANT.

	Art.		Finish
Material:	CLF 490	AS	Silver
Extruded anodised aluminium	CLF 490	AO	Gold
Length: 2,70 metres	CLF 490	AB	Bronze
0,90 / 1,35 metres			

### MULTICLIP® CLF 490\* Aluminium Wood Cladding Finish

Profile with a melamine wood tone in 8 different varieties. Good tolerance to abrasion comparable to most melamine coverings. The melamine embossing on the aluminium is particularly smooth therefore it remains quite clean and blends well with the flooring tone.

Mounts with Clip CL 80 P + aluminium base CLB 80 ANF / ANT.

Material:	CLF 490	RS	Whitened
Extruded Aluminium Laminate cov.	CLF 490	AC	Maple
Length: 2,70 metres	CLF 490	FA	Beech
0,90 / 1,35 metres	CLF 490	RO	Oak
	CLF 490	CI	Cherry
	CLF 490	NC	Light walnut
	CLF 490	NS	Dark walnut
	CLF 490	WE	Wengé

### MULTICLIP® CLF 490 OL Polished Brass

Innovative: the new modular system Multiclip® allows to use also the traditional brass finishing profiles, as the clips in Resinil avoid binding. Solid polished brass for a lasting classic finish and a very good resistance to mechanical impacts.

Mounts with Clip CL 80 P + aluminium base CLB 80 ANF / ANT.

Material:	CLF 490	OL	Polished Brass
Extruded Brass			
Length: 2,70 metres			
0,90 / 1,35 metres			

Pre-cut length available in SELFLINE kit L= 0,90/1,35 m



# multiclip® CLP 270

Perimeter joint in aluminium. It provides movement joint avoiding the use of skirting board, thanks to its 16 mm internal cavity with a fixing bar that allows on average  $\pm 5$  mm floor movement. It is also suitable for trimming sliding doors tracks and entrance mattings.

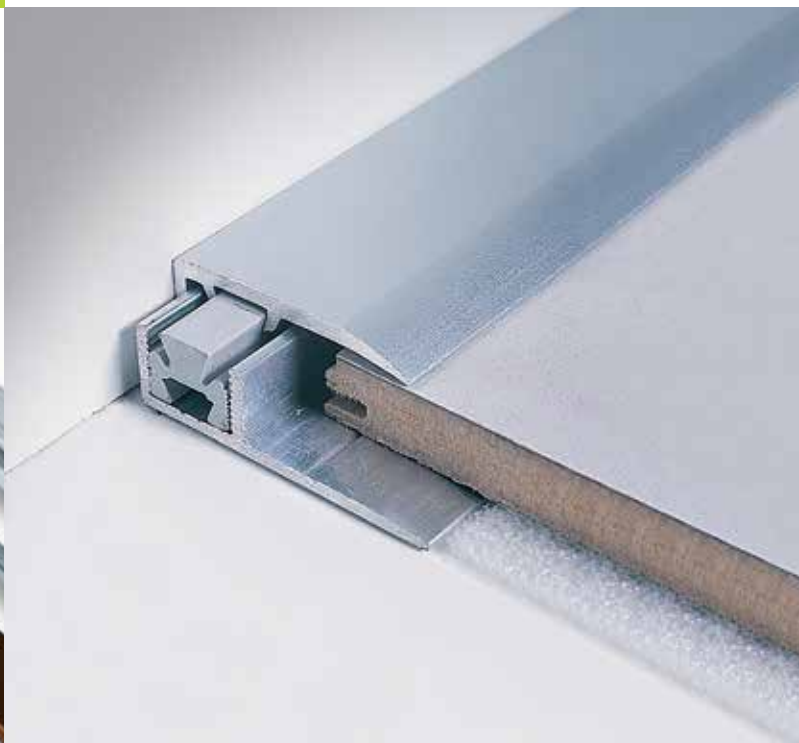
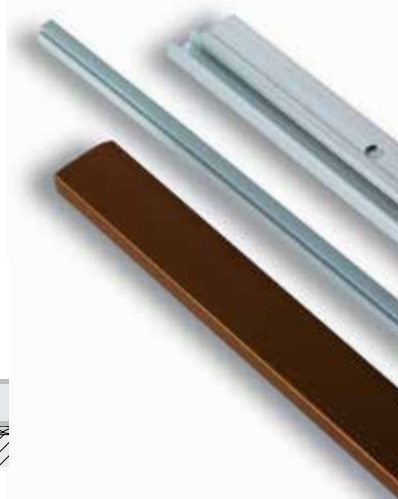
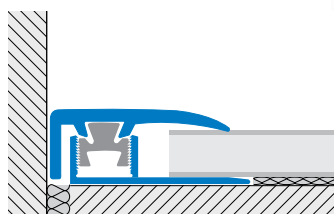
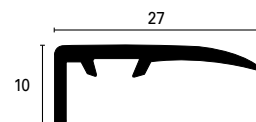

### MULTICLIP® CLP 270 A\* Anodised aluminium

The profile is anodised aluminium with a Silver, Gold or Bronze colour finish. The profile is adaptable to several coverings thanks to its versatility characteristics.

Mounts with Clip CL 80 P + aluminium base CLB 80 ANF / ANT.

### MULTICLIP® CLP 270\* Aluminium Wood Cladding Finish

Profile with a melamine wood tone in 8 different varieties. Good tolerance to abrasion comparable to most melamine coverings. The melamine embossing on the aluminium is particularly smooth therefore it remains quite clean and blends well with the flooring tone.

Mounts with Clip CL 80 P + aluminium base CLB 80 ANF / ANT.

	Art.			Finish
Material:	CLP	270	AS	Silver
Extruded anodised aluminium	CLP	270	AO	Gold
Length: 2,70 metres	CLP	270	AB	Bronze

Material:	CLP	270	RS	Whitened
Extruded Aluminium Laminate cov.	CLP	270	AC	Maple
Length: 2,70 metres	CLP	270	FA	Beech
	CLP	270	RO	Oak
	CLP	270	CI	Cherry
	CLP	270	NC	Light walnut
	CLP	270	NS	Dark walnut
	CLP	270	WE	Wengé





# multiclip® CLS 250

Stair nosing profile in aluminium or with laminate wood tone cladding contributes to better identify the treading edge as well as protect and give a step safety feature to the staircase and mask imperfections.

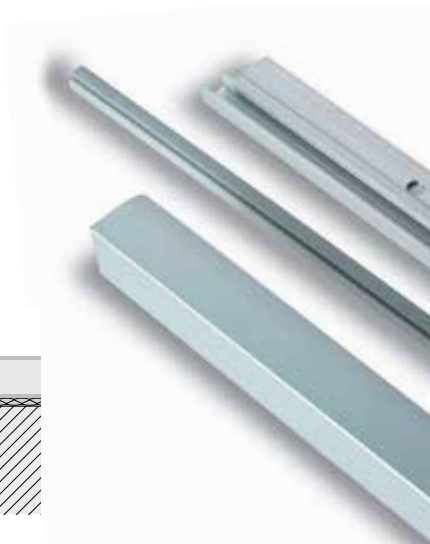
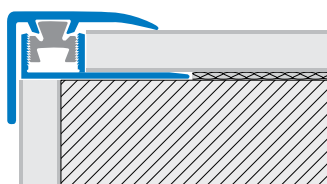
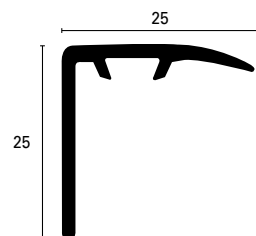

### MULTICLIP® CLS 250 A\* Anodised aluminium

The profile is anodised aluminium with a Silver, Gold or Bronze colour finish. The profile is adaptable to several coverings thanks to its versatility characteristics.

Mounts with Clip CL 80 P + aluminium base CLB 80 ANF / ANT.

### MULTICLIP® CLS 250\* Aluminium Wood Cladding Finish

Profile with a melamine wood tone in 8 different varieties. Good tolerance to abrasion comparable to most melamine coverings. The melamine embossing on the aluminium is particularly smooth therefore it remains quite clean and blends well with the flooring tone.

Mounts with Clip CL 80 P + aluminium base CLB 80 ANF / ANT.

	Art.		Finish
Material:	CLS 250	AS	Silver
Extruded anodised aluminium	CLS 250	AO	Gold
	CLS 250	AB	Bronze
Length: 2,70 metres			

Material:	CLS 250	RS	Whitened
Extruded Aluminium Laminate cov.	CLS 250	AC	Maple
	CLS 250	FA	Beech
	CLS 250	RO	Oak
	CLS 250	CI	Cherry
	CLS 250	NC	Light walnut
	CLS 250	NS	Dark walnut
	CLS 250	WE	Wengé
Length: 2,70 metres			



# multifix™ CLG 300

Jointing profile strip slightly cambered for matching floors at the same level. This article has been expressly designed for domestic environments and DIY market, with the nylon "MULTIFIX" dowel screws for the installation.

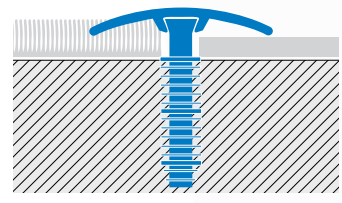
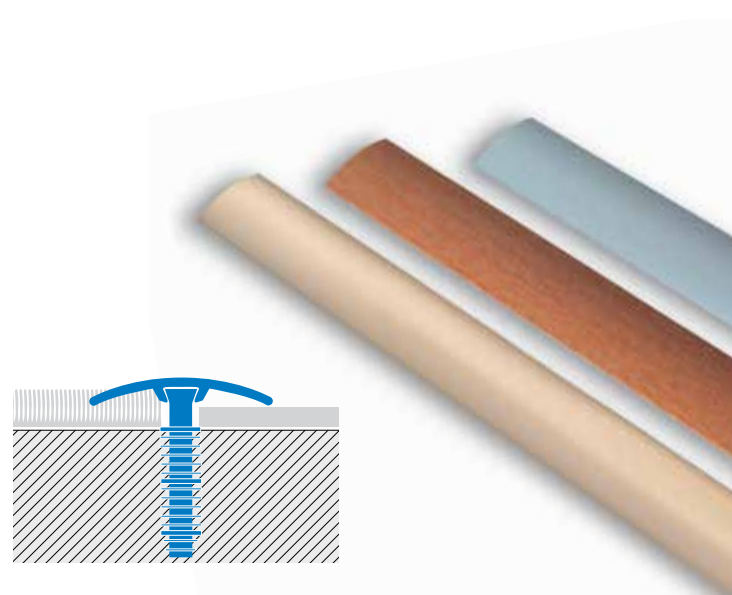
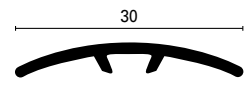

### MULTIFIX CLG 300 A\* Anodised aluminium

The profile is anodised aluminium with Silver, Gold or Bronze colour finish. The profile is adaptable to several floors thanks to its versatility characteristics.

Mounts with nylon dowels code CLX 45.

	Art.			Finish
Material:	CLG 300	AS		Silver
Extruded anodised aluminium	CLG 300	AO		Gold
Length: 2,70 metres	CLG 300	AB		Bronze
0,90 / 1,35 metres				

### MULTIFIX CLG 300\* Aluminium Wood Cladding Finish

Profile with a melamine wood tone in 8 different varieties. Good tolerance to abrasion comparable to most melamine coverings. The melamine embossing on the aluminium is particularly smooth therefore it remains quite clean and blends well with the flooring tone.

Mounts with nylon dowels code CLX 45.

Material:	CLG 300	RS		Whitened
Extruded Aluminium Laminate cov.	CLG 300	AC		Maple
Length: 2,70 metres	CLG 300	FA		Beech
0,90 / 1,35 metres	CLG 300	RO		Oak
	CLG 300	CI		Cherry
	CLG 300	NC		Light walnut
	CLG 300	NS		Dark walnut
	CLG 300	WE		Wengé

### MULTIFIX CLG 300 OL Polished Brass

Solid brass polished trim for to classic lasting finish and a very good resistance to mechanical impacts.

**Note:** order one set of dowels each metre.

Material:	CLG 300	OL		Polished Brass
Extruded Brass				
Length: 2,70 metres				
0,90 / 1,35 metres				

Pre-cut length available in SELFLINE kit L= 0,90/1,35 m



# multiclip® e multifix™

MULTICLIP® e MULTIFIX are patented systems easy to mount and to dismount without damaging the work done.

### MULTICLIP® assembly:

1. Set the base profile in position using either screws and dowels or the perforated fixing base flange for adhesive laying.
2. Align the base section to the wooden floor edge to allow to suitable gap for expansion joints.
3. Insert one or more "clips" into the finishing profile and align onto the fixing base.
4. Protecting the finishing profile with a wooden batten tap the clips into the fixing base.

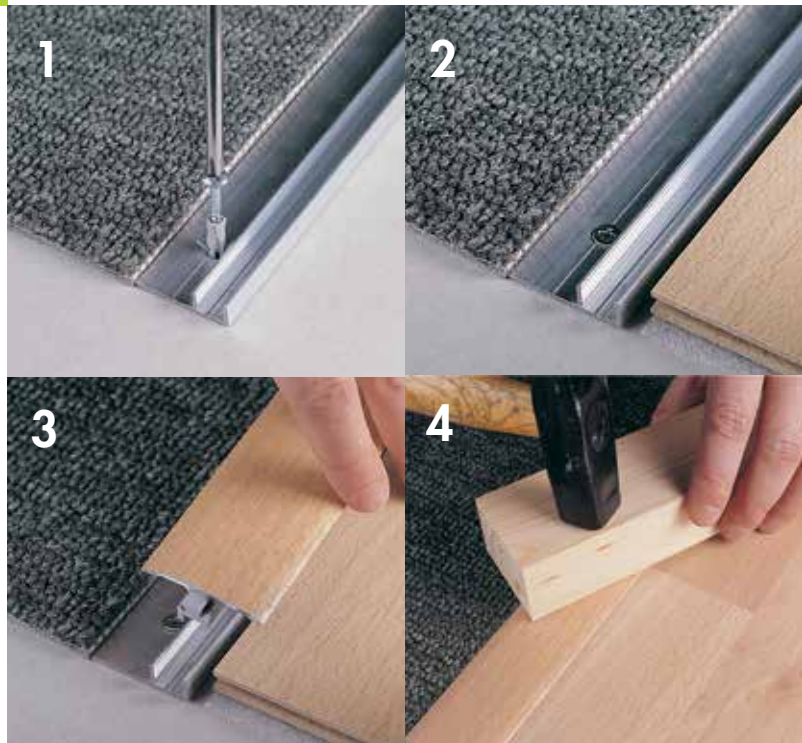

### MULTICLIP® disassembly

Where necessary, the profile can be easily removed without damaging the laid floor or the fixing base.

1. Drill hole with a 3 mm drill bit
2. Insert a 4 mm screw
3. Lift and remove



### MULTIFIX assembly

The profile series MULTICLIP® may be assembled and laid by use of the nylon dowel "MULTIFIX" whenever there is a limited or residential type of pedestrian transit. The MULTIFIX dowel is utilized with these articles: CLG 300, CLG 370, CLF 450.

1. Drill hole using a 6 mm drill bit
2. Insert the dowels
3. Align the dowels
4. Hammer in with protecting batten

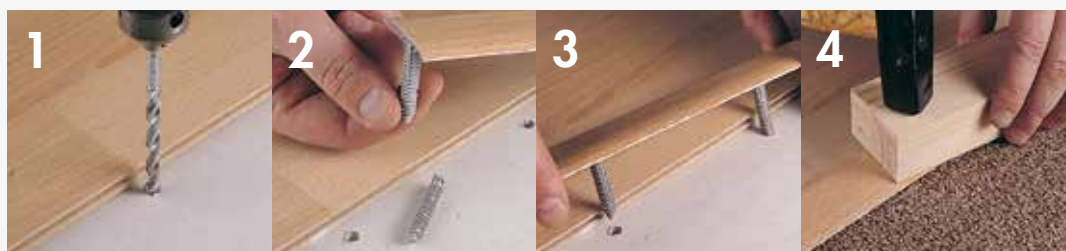





# multicover™

Profile with a melamine wood tone in 8 different varieties. Good tolerance to abrasion comparable to most melamine coverings. The melamine embossing on the aluminium is particularly smooth, therefore it remains quite clean and blends well with the flooring tone.



**Installation for self-adhesive version:**

- 1) Check if support is sound, smooth, clean, dry and free from grease and loose materials.
- 2) Cut profile to the required length and remove the protective film.
- 3) Press downwards on the profile until it is fixed firmly. Do not hammer.

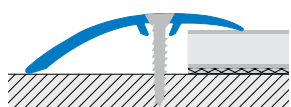

**Installation for pre-drilled version:**

- 1) Cut profile to the required length and mark the holes position.
- 2) Insert the dowels and fix in using suitable flare head screws.

**MULTICOVER** represents two further possibilities of alternative fixing for the junction and edging profiles series CLG and CLF, with wood clad finish. These profiles are actually available also in the drilled version for fixing with screws and dowels, or self adhesive, provided with a special high quality elastomer adhesive for easier application. For installation just cut the profile to the required length, remove the protective film and press downward on the profile until it is fixed firmly. For a good hold the support must be sound, smooth, clean, dry and free from grease and loose materials.



**MULTICOVER CLG 370\* Aluminium Wood Cladding Finish**

Junction profiles for floors at the same height.

	B=mm	Finish	Adhesive			Drilled		
Material:	37	Whitened	CLG	370	RSA	CLG	370	RSF
Extruded Aluminium Laminate cov.	37	Maple	CLG	370	ACA	CLG	370	ACF
Length: 2,70 metres	37	Beech	CLG	370	FAA	CLG	370	FAF
0,90 / 1,35 metres	37	Oak	CLG	370	ROA	CLG	370	ROF
	37	Cherry	CLG	370	CIA	CLG	370	CIF
	37	L. walnut	CLG	370	NCA	CLG	370	NCF
	37	Dark walnut	CLG	370	NSA	CLG	370	NSF
	37	Wengé	CLG	370	WEA	CLG	370	WEF

**MULTICOVER CLF 450\* Aluminium Wood Cladding Finish**

Terminal profile for mismatching floors ranging between 6 ÷ 11 mm.

	B=mm	Finish	Adhesive			Drilled		
Material:	45	Whitened	CLF	450	RSA	CLF	450	RSF
Extruded Aluminium Laminate cov.	45	Maple	CLF	450	ACA	CLF	450	ACF
Length: 2,70 metres	45	Beech	CLF	450	FAA	CLF	450	FAF
0,90 / 1,35 metres	45	Oak	CLF	450	ROA	CLF	450	ROF
	45	Cherry	CLF	450	CIA	CLF	450	CIF
	45	L. walnut	CLF	450	NCA	CLF	450	NCF
	45	Dark walnut	CLF	450	NSA	CLF	450	NSF
	45	Wengé	CLF	450	WEA	CLF	450	WEF

Pre-cut length available in SELFLINE kit L= 0,90/1,35 m





This terminal edge perimeter profile trim is especially designed for floating wooden floors to ideally finish a wall edge and adjacent floors. It also serves as an expansion joint and is an alternative to skirting. Also ideal for edging sliding doors tracks and entrance mat edging. It can be fixed with dowels or screws and guarantees a perfect hold. To be fixed with screws and dowels.

woodtec™ LT

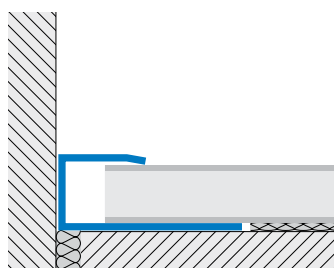
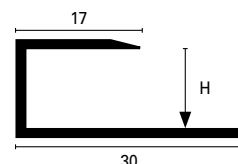

**WOODTEC LT-A\*N Anodised aluminium**

The profile is anodised aluminium with Silver (AS), Gold (AO) or Bronze (AB) colour finish. The profile is easily adaptable to several coverings for colour and texture and is well tolerant to oxidation but less resistant to mechanical impact. In areas with higher transit the use of the solid brass article is recommended.

	H=mm	Art.		
Material:	7	LT	70	A*N
Extruded anodised aluminium	9	LT	90	A*N
Finish*: Silver (AS), Gold (AO), Bronze (AB)	10	LT	100	A*N
	13	LT	130	A*N
	15	LT	150	A*N
Length: 2,70 metres				

**WOODTEC LT-OLN Polished Brass**

Thanks to the natural properties of brass, this profile is highly tolerant to mechanical impact and areas subject to chemical presence yet still helps maintain an elegant finish to the coverings applied.

Material:	10	LT	100	OLN
Laminated Brass	15	LT	150	OLN
Finish: Polished (OLN)	22	LT	220	OLN
Length: 2,70 metres				

**WOODTEC LT-ILN Polished Stainless Steel**

High tolerance steel profile particularly recommended for commercial and industrial environments. This article is also recommended for heavy transit areas offering a good mechanical resistance.

Material:	10	LT	100	ILN
Stainless Steel	15	LT	150	ILN
Finish: Polished (ILN)	22	LT	220	ILN
Length: 2,70 metres				

**WOODTEC LT 90\*N Aluminium Wood Cladding Finish**

Profile for the most common mismatching floors ranging between 7,5 and 9 mm. Melamine wood tone in 8 different varieties. Good tolerance to abrasion comparable to most melamine coverings. The melamine embossing on the aluminium is particularly smooth therefore it remains quite clean and blends well with the flooring tone.

	Finish	Art.		
Material:	Whitened	LT	90	RSN
Extruded Aluminium Laminate cov.	Maple	LT	90	ACN
Length: 2,70 metres	Beech	LT	90	FAN
	Oak	LT	90	RON
Finish*: 8 wood finish	Cherry	LT	90	CIN
	Light walnut	LT	90	NCN
	Dark walnut	LT	90	NSN
Altezza: 9 mm	Wengé	LT	90	WEN



This terminal edge perimeter profile trim is especially designed for floating wooden floors to ideally join them to adjacent floors of lower level or to existing floors. It serves as an expansion with the extra internal gap. This profile is to be fixed with screws and dowels.

woodtec™ LP

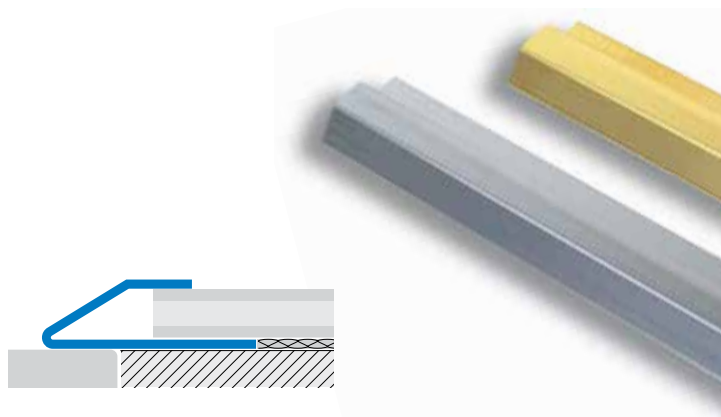
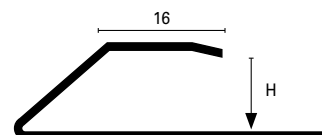

**WOODTEC LP-OLN Polished Brass**

Thanks to the natural properties of brass, it ensures a good tolerance to mechanical impact and in areas subject to chemical presence, it still contributes to maintain an elegant finish to the coverings applied. Through contact with moisture or corrosive media, brass may oxidize on exposed surfaces. This situation can be easily solved by buffing the product with a conventional polisher to return to its original shine.

**WOODTEC LP-ILN Polished Stainless Steel**

High tolerance stainless steel profile particularly recommended for commercial and industrial environments. This article is also recommended for heavy transit areas offering a good mechanical resistance.

	H=mm	Art.		
Material:	10	LP	100	OLN
Laminated Brass	15	LP	150	OLN
Finitura: Polished (OLN)	22	LP	220	OLN
Length: 2,70 metres				
Protected surfaces with film				

Material:	10	LP	100	ILN
Stainless Steel	15	LP	150	ILN
Finish: Polished (ILN)	22	LP	220	ILN
Length: 2,70 metres				
Protected surfaces with film				



Junction profile especially designed for floating wooden floors. The shape and dimension of the profile allow enough space for the wood natural expansion. The flat top face is also suitable for threshold under doorways.

woodtec™ LG

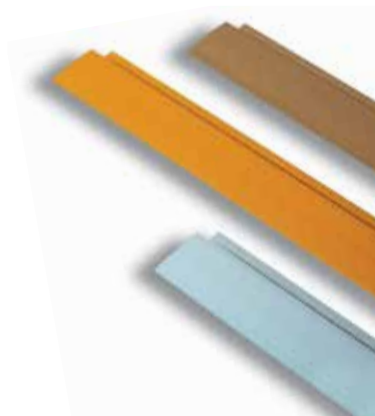
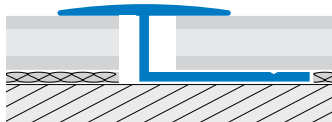
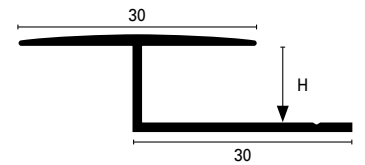

**WOODTEC LG-A\*N Anodised aluminium**

Profile in anodised aluminium Silver (AS), Gold (AO) or Bronze (AB). Considered ideal for classier decorative internal coverings. Highly resistant to oxidation but less tolerant to mechanical stress for it is meant for residential areas.

	H=mm	Art.		
Material:	7	LG	70	A*N
Extruded anodised aluminium	9	LG	90	A*N
Finish*: Silver (AS), Gold (AO), Bronze (AB)	10,2	LG	100	A*N
	13	LG	130	A*N
Length: 2,70 metres	15	LG	150	A*N



Joining profile with a fixing base for before carpet laying and top strip with grooved surface to be interlocked onto the base bar once the carpet is laid. Toothed base bar or pre-drilled is available. The base and the upper top are two different articles to be ordered separately.

carpetec™ MG

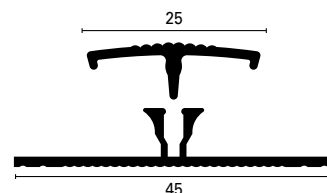

**CARPETEC MG 25 A\*N Anodised Aluminium - Top**

Top profile available in three different aluminium colour finishes: Silver (AS), Gold (AO), Bronze (AB). The profile is commonly used in domestic environments.

**CARPETEC MG 25 OLN Polished Brass - Top**

Top profile in polished brass highly resistant to mechanical impact, chemical corrosion and wear and tear.

**CARPETEC MGB 25 AN\* Natural aluminium - Fixing base**

Drilled base to be fixed with screws and dowels, for glued carpet, code F. Toothed base for stretched carpet, code D.

	B=mm	MG	Art.	
Material:	25	MG	25	ASN
Extruded anodised aluminium	25	MG	25	AON
Finish*: Silver (AS), Gold (AO), Bronze (AB)	25	MG	25	ABN
Length: 2,70 metres				

Material:	25	MG	25	OLN
Extruded Brass				
Finish: Polished (OLN)				
Length: 2,70 metres				

Material:	43	MGB	25	ANF
Alluminium	43	MGB	25	AND
Finish: Natural (AN*)				
Length: 2,70 metres				





This multifunctional profile has a self adjusting feature which allows it to automatically adjust to differing flooring heights. Terminal or junction between two different coverings.

carpetec™ MP

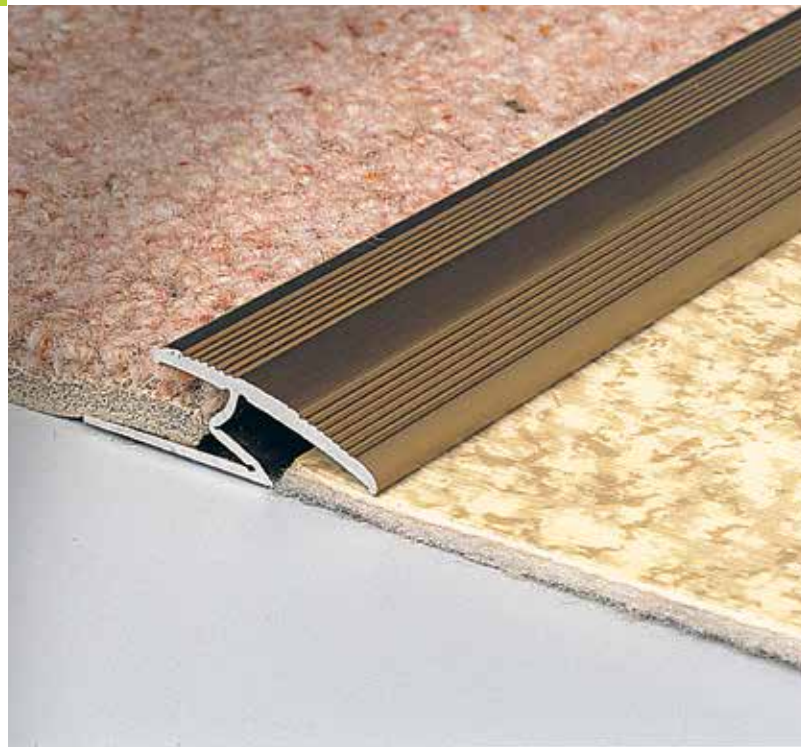
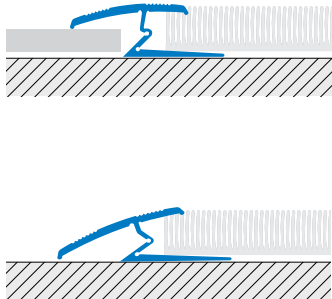
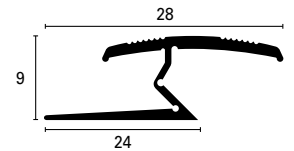

**CARPETEC MP 28 A Anodised aluminium**

This anodised aluminium profile is available in three different colour finishes: Silver (AS), Gold (AO), Bronze (AB). The profile is commonly used in domestic environments for the colour coordination. Available with self-adhesive base (\*A) for a quick installation or drilled base (\*F) to be installed with screws and dowels.

	B=mm	Art.		Adhesive	Drilled
Material:	28	MP	28	ASA	ASF
Extruded anodised aluminium	28	MP	28	AOA	AOF
Finish: Silver (AS), Gold (AO), Bronze (AB)	28	MP	28	ABA	ABF
Length: 2,70 metres					
0,90/1,35 metres					

Pre-cut length available in SELFLINE kit L= 0,90/1,35 m



Terminal profile for flexible or soft coverings such as fitted moquette carpeting or coco/fibre rug. By pressing down on the profile it will adjust to the thickness of the covering protecting the edge and cover imperfections.

carpetec™

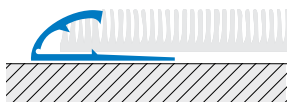

**CARPETEC MA 24 A\*A Anodised Aluminium (with adhesive)**

Self adjusting carpet profile trim. Self-adhesive bottom strip to guarantee a firm hold on any surface without raising the height.

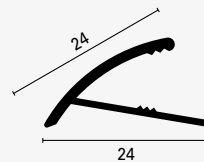

	B=mm	Art.		
Material:	24	MA	24	ASA
Extruded anodised aluminium	24	MA	24	AOA
	24	MA	24	ABA
Length: 2,70 metres				
0,90 / 1,35 metres				

**CARPETEC MS 26 A\* Anodised Aluminium (drilled o with adhesive)**

Self adjusting profile with less face surface for a neat and more discreet finish. To be fixed with screws and dowels. Available also self-adhesive (A\*A) and Drilled (A\*F).

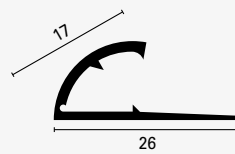

Material:	26	MS	26	ASF/A
Extruded anodised aluminium	26	MS	26	AOF/A
	26	MS	26	ABF/A
Length: 2,70 metres				
0,90 / 1,35 metres				

**CARPETEC MS 26 OLN Polished Brass**

Solid brass profile, guarantees an excellent resistance to mechanical and chemical impacts while conveying a long lasting "classic" finish.

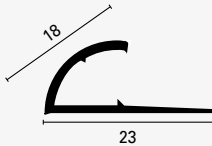

Material:	26	MS	26	OLN
Extruded Brass				
Finish: Polished (OLN)				
Length: 2,70 metres				
0,90 / 1,35 metres				

**CARPETEC MD 43 A\*F Anodised Aluminium (drilled)**

Ideal for border edging for fitted moquette carpeting and gangways thanks to the ample mounting flange which can be also prepared with self adhesive tape.

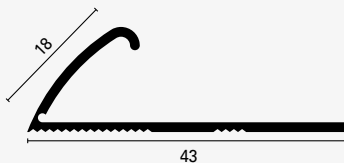

Material:	43	MD	43	ASF
Extruded anodised aluminium	43	MD	43	AOF
	43	MD	43	ABF
Length: 2,70 metres				

**CARPETEC MD 43 A\*D Anodised Aluminium(toothed)**

Profile with internal toothed flange for better grip for stretching carpeting.

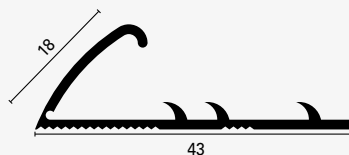

Material:	43	MD	43	ASD
Extruded anodised aluminium	43	MD	43	AOD
	43	MD	43	ABD
Length: 2,70 metres				

Pre-cut length available in SELFLINE kit L= 0,90/1,35 m



Terminal edges and nosing profile trims for coverings in PVC, linoleum or other thin material coverings, with 2 ÷ 3 mm thickness, just like the needle-punched pressed rugs.

These profiles ensure a clean and neat finish with a slight extra height adding and hide cutting imperfections.

linotec™

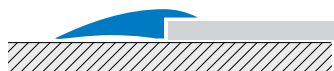

**LINOTEC AP 17 AS\* Anodised Aluminium (with adhesive)**

Flat level terminal trim slightly rounded and self-adhesive for mismatching 2 ÷ 3 mm floors. Profile developed in Silver anodised aluminium which is well suited for domestic environments and colour combinations. Available also in the non-adhesive version (ASN).

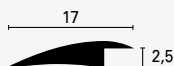

	B=mm	Art.		
Material:	17	AP	17	ASA
Extruded anodised aluminium	17	AP	17	ASN
Length:	2,70 metres			

**LINOTEC AP 19 OL\* Polished Brass (with adhesive)**

Flat level terminal trim slightly rounded and self-adhesive for mismatching 2 ÷ 3 mm floors. Solid brass polished profile with good resistance to mechanical impact, chemical corrosion and wear and tear. Available also in the non-adhesive version (ASN).

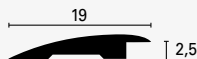

Material:	19	AP	19	OLA
Extruded Brass	19	AP	19	OLN
Finish: Polished (OL*)				
Length:	2,70 metres			
Superficie con film protettivo				

**LINOTEC AV 30 OL\* Polished Brass (with adhesive)**

A well contoured profile for mismatching floors from 2 ÷ 3 mm. Solid brass polished profile highly resistant to mechanical impact, chemical corrosion and wear and tear. Also not self-adhesive.



Material:	30	AV	30	OLA
Laminated Brass				
Finish: Polished (OL*)				
Length: 2,70 metres				
0,90/1,35 metres				

Pre-cut length available in SELFLINE kit L= 0,90/1,35 m

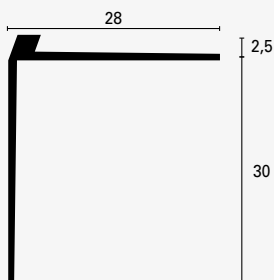

**STAIRTEC SC 30 A\*N Anodised Aluminium**

Stair nosing profile for resilient flooring suitable for thicknesses ranging between 2 and 3 mm. Fast and lasting stair step finish.

	H*+H	Art.		
Material:	2,5+30	SC	30	ASN
Extruded anodised aluminium	2,5+30	SC	30	AON
Finish: Silver (AS), Gold (AO), Bronze (AB)	2,5+30	SC	30	ABN
Length:	2,70 metres			









## Profiles for stair nosing

When finishing a staircase with ceramic or other flooring materials it is important to consider two important factors: safety and appearance. By using the proper profile both these requirements can be satisfied.

Profiles with anti-slip insert rubber strips or tread grooves provide a higher safety feature. The use of a stair nosing allows the choice of a wide range of floor coverings. Many ceramic tiles, for example, do not have special edging profiles available for use on stairs.

PROFILITEC® proposes a wide range of technical stairnosings, suitable for all kinds of floor coverings and perfectly meeting with the European safety standards currently in force: ideal then for renovations and updating works of public buildings. The profile offers a long lasting protection and better defines the step and ensures resistance to wear and tear over time.

Article		Use	Page
Stairtec	FSF	tiled steps	76
Stairtec	FSL	tiled steps	77
Stairtec	FS	tiled steps	78
Stairtec	FI	stainl.steel for ceramic tiles	79
Stairtec	FW	wood for ceramic tiles	80
Stairtec	SR	metal for ceramic tiles	81
Stairtec	FL	decorative for ceramic tiles	82
Stairtec	FL	dec. st.steel for ceramic	83
Series	RJ-RD	tiled steps	84
Squarejolly	SJ	square edge for tiles	85
Roundjolly-Squarejolly	RJ/SJM	ultra-thin tiles	86
Stairtec	FO	techn. nosing for wood / ceramic	87
Stairtec	SWP	pacer circular element in st.steel	88
Stairtec	SWR	circular anti-slip element in st.steel	89
Stairtec	SW	aluminium anti-slip	90
Stairtec	SI	st.steel on existing surfaces	91
Stairtec	AE	ribbed on existing floors	92
Stairtec	SE	aluminium safety step	93
Stairtec	SA	aluminium anti-slip	94
Walktec	SWH	anti-slip self-adhesive	95
Stairtec	SL	on existing surfaces	96
Stairtec	SC	vynil floors	97
Stairtec	SM	moquettes	98
Stairtec	SM	moquettes	99

# 02\_



Ceramic tile laying jobs may sometimes be quite delicate with problems which differ from standard applications such as linear wall tiling. Stairs, for instance, to be covered with the same tiles as the floor may require non standard spacing to match different heights from step to connecting floor for example.

The STAIRTEC product range is conceived to face these adjustment problems by featuring valid and lasting technical solutions.

## stairtec™ FSF

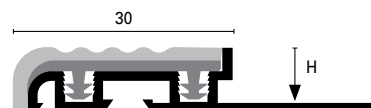

This is the section for H 8 and 10 mm. For H 12,5 mm the section is different



The product FSF is certified R10.  
Anti-slip properties. According to standard DIN 51130 (06/2004).

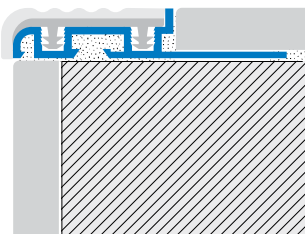
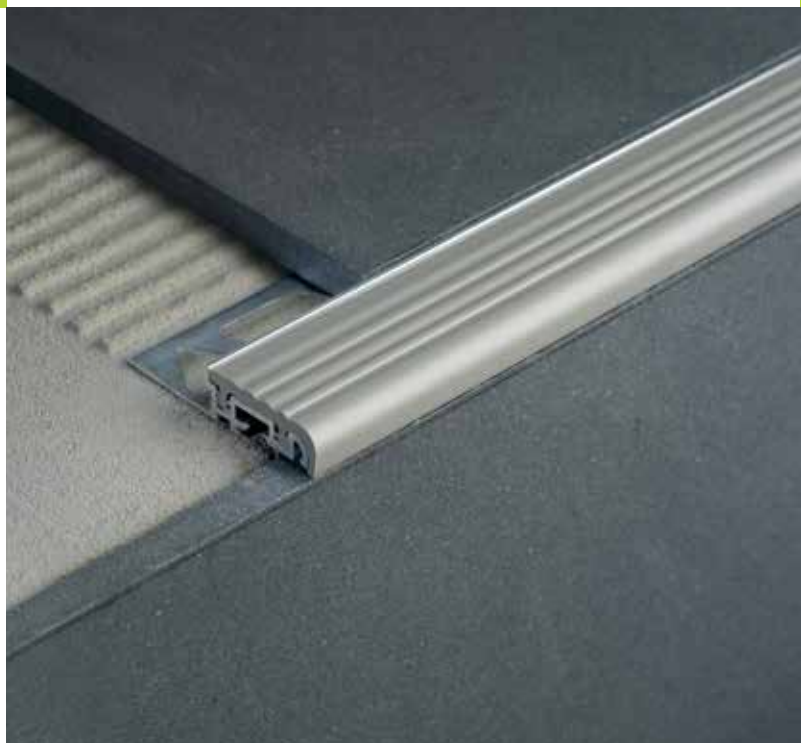

**STAIRTEC FSF-A\* Aluminium + Synthetic insert width 30 mm**  
Base profile in aluminium with an anti-slip synthetic insert strip already mounted which can be replaced in case of damage or wear.  
End caps FST available for each height 8 / 10 / 12,5 mm.

	H=mm	Art.		Insert Colours	
Material:	8	FSF	80	A*	23/32/51
Extruded Natural aluminium	10	FSF	100	A*	23/32/51
Synthetic Insert	12,5	FSF	125	A*	23/32/51
Length: 2,70 metres					
Width: 30 mm					
Colours*: Grey (23), Beige (32), Black (51)					

Material:	8	FST	80	P*	23/32/51
PVC	10	FST	100	P*	23/32/51
Colours*: Grey (23), Beige (32), Black (51)	12,5	FST	125	P*	23/32/51

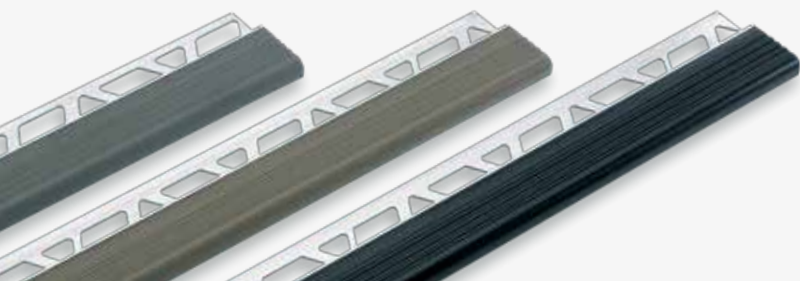



stairtec™ FSL

STAIRTEC series proposes technical effective, practical and long-lasting solutions for the stairnosing finishes, according to the most recent UE safety standards which provide proper anti-slip elements.

“Riser cover” device , patented system.

FSL “riser cover” device is a patented system.

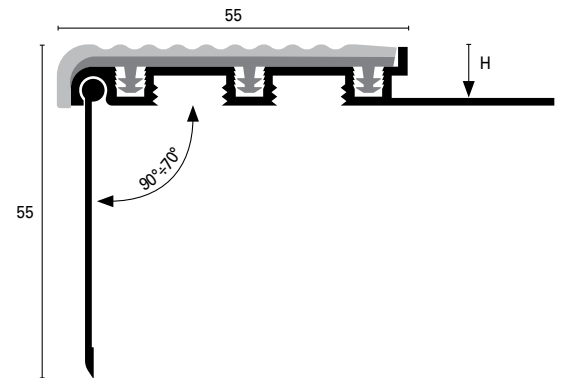

**STAIRTEC FSL-A\*Aluminium + Synthetic insert width 55 mm**

Base profile in aluminium with an anti-slip synthetic insert strip already mounted which can be replaced in case of damage or wear.

End caps FSLT available for each height 8 / 10 / 12,5 mm.

Spare insert, code FSLI 55 P\*.

	H=mm	Art.		Insert colours	
Material:	8	FSL	80	A*	23/32/51
Extruded Natural aluminium	10	FSL	100	A*	23/32/51
Synthetic Insert	12,5	FSL	125	A*	23/32/51
Length: 2,70 metres					
Width: 55 mm					
Colours*: Grey (23), Beige (32), Black (51)					

**STAIRTEC FSA 50 AS Anodised Aluminium Silver**

Optional riser in anodised aluminium for use with stair edging base profile FSL, to allow improved step edge visibility or partially covering the riser, in line with the most recent accessibility standards.

Material:	50	FSA	50	AS	-
Extruded anodised aluminium					
Length: 2,70 metres					
Height: 50 mm					
Finish: Silver (AS)					

**STAIRTEC FSLT End caps**

End caps to complete the profile in a proper and neat way.

Material:	8	FSLT	80	P*	23/32/51
Polypropylene	10	FSLT	100	P*	23/32/51
Colours*: Grey (23), Beige (32), Black (51)	12,5	FSLT	125	P*	23/32/51



stairtec™ FS

**STAIRTEC FS** is a patented product with the "Clip System". Ceramic tile laying jobs may sometimes be quite delicate with problems which differ from standard applications such as linear wall tiling. Stairs, for instance, to be covered with the same tiles as the floor may require non standard spacing to match different heights from step to connecting floor for example. The STAIRTEC product range is conceived to face these adjustment problems by featuring valid and lasting technical solutions.

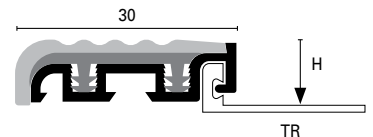

The product FS is certified R10. Anti-slip properties. According to standard DIN 51130 (06/2004).

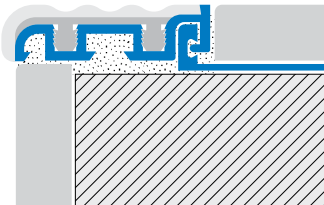

**STAIRTEC FS 30 A\* Aluminium+ Synthetic insert**

"Clip System" patented.

The system combines an aluminium base section- equipped with an anti-slip insert- with a profile TRIMTEC chosen with the desired height-which works as a fixing flange. The system works even with the off-cuts of TR series with a consequent economical advantage.

To choose the correct height of trim to be used, subtract 2 mm from the tile thickness you need to match with.

Example: for 10 mm tiles, insert TRIMTEC H = 8 mm into the basic module STAIRTEC FS, as STAIRTEC FS will increase the overall height of the assembled section by 2 mm. The required 10 mm thickness is then achieved. The synthetic resin insert can be replaced in case of damage or wear and tear.

**CHARACTERISTICS**

Base profile in aluminium, with an anti-slip synthetic insert strip for pre inserted in base. TRIMTEC flange profile is not included as it is to be ordered separately based upon the desired height to match the tile (Tile H reduced by 2 mm). Available endplugs FST height 8/ 10/ 12,5 mm.

	B=mm	Art.		Insert colours	
Material: Extruded Natural aluminium	30	FS	30	A*	23/32/51
Synthetic Insert					
Length: 2,70 metres					
Width: 30 mm					
Colours*: Grey (23), Beige (32), Black (51)					

Material: PVC	8 10 12,5	FST FST FST	80 100 125	P* P* P*	23/32/51 23/32/51 23/32/51
Colours*: Grey (23), Beige (32), Black (51)					



H=mm	Art.		
4,5	TR	45	AN
6	TR	60	AN
8	TR	80	AN
10	TR	100	AN
12,5	TR	125	AN
15	TR	150	AN
17,5	TR	175	AN
20	TR	200	AN





**STAIRTEC FI** is a technical profile especially designed to edge ceramic or porcelain stoneware tile steps. It is highly resistant and is an economic solution to the "special ceramic edge piece". Although made of steel it can still give a pleasant look to the staircase, especially in public or commercial areas. **STAIRTEC FI** can handle intense pedestrian transit and maintains its safety feature thanks to the carborundum anti-slip strips on its surface.

stairtec™ FI

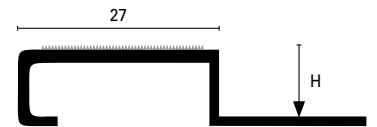

(FI 100\*)



The product SWH is certified R13 (Anti-slip insert).  
Anti-slip properties. According to standard DIN 51130 (06/2004).

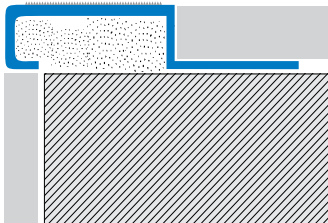

**STAIRTEC FI-IL Polished Stainless Steel AISI 304 - DIN 1.4301**

Stainless steel profile, AISI 304 standard, ensures good tolerance to corrosion recommended for laboratories, food processing plants, commercial kitchens, slaughter houses, breweries and public toilets.

The anti-slip insert is supplied separately as it needs to be applied on the FI profile already installed, on a clean and dry surface.

19 mm insert available in black (C51) or photoluminescent (CF).

	H=mm	Art.		
Material:	8	FI	80	IL
Stainless steel AISI 304	10	FI	100	IL
Finish: Polished (IL)	12,5	FI	125	IL
Length: 2,70 metres				

	mm x m	Art.		
Anti-slip strip black	19x18,3	SWH	19	C51
Anti-slip strip fotoluminescente	19x18,3	SWH	19	CF



**STAIRTEC FW** is a stair nosing in natural solid wood, with a supporting angular structure in perforated aluminium to improve its fixing and stability. Its simple shape and size make it a finish suitable for all kind of environments, either modern or traditional. Ideal for step applications in domestic areas, it performs well also to contour tiled kitchen tops.

stairtec™ FW

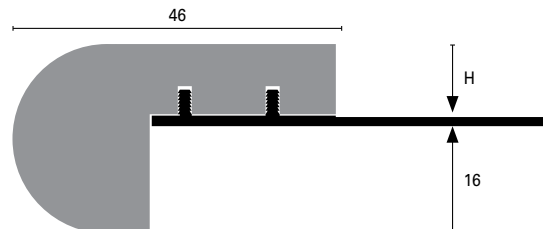

(FW 100\*)

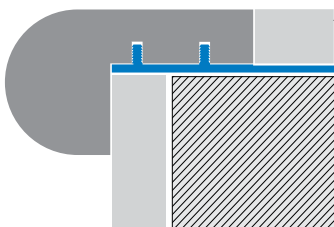

**STAIRTEC FW-RON Oak natural finish**

Profile in natural solid wood with support in perforated aluminium for gluing and reinforcing.

The profile is supplied pre-assembled. Prior to installation the wood element should be treated with a suitable coating or protective oil to achieve the required colour.

	H=mm	Art.			Finish
Material:	10	FW	100	RON	Oak
Extruded Natural aluminium	12,5	FW	125	RON	Oak
Natural Oak (RON)	15	FW	150	RON	Oak
Length: 2,70 metres					



stairtec™ SR

**STAIRTEC SR** is a linear profile, which works very well as stair nosing for steps and finishing trim for all exposed corners, thanks to its quick and practical application covering perfectly well the tile gap over the step while protecting the edge. The SR trim has an extended vertical edge which serves to better cover and protect the joining surfaces or paint finishing, avoiding future fissuring.

Its particular section design makes it suitable to match two different floor thicknesses for example 10 and 12,5 mm with the same reversible profile. Vertical anchorage with dovetail internal cavity groove. Patented system.

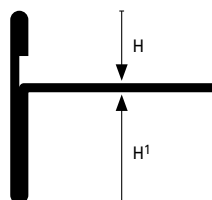

Aluminium section

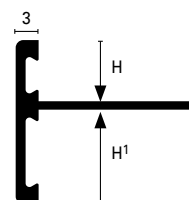

Aluminium and Brass section

(SR 8/15\*)

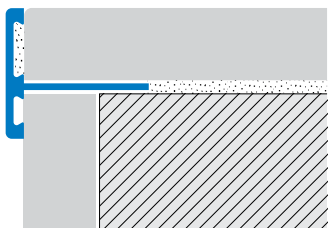

**TRIMTEC SR-O\* Brass**

The particular straight edge cut profile guarantees protection of vulnerable edges of ceramic stairs. Brass suffers from continuous exposure to humidity leading to oxidation of the surface – a normal polish buffing will bring the product back to its original shine.

**TRIMTEC SR-AS Extruded anodized aluminium- silver**

This profile has a silver coating and is suitable for both indoor or outdoor application with high tolerance to weather agents but less to mechanical impact. During installation excess adhesive and grout should be removed immediately to avoid stains. The exposed surface may change colour or darken in time. Where higher stresses are involved the use of brass profiles is recommended.

**TRIMTEC SR-I\* Stainless Steel AISI 304 - DIN 1.4301**

This stainless steel profile is AISI 304 standard which ensures high tolerance to corrosion found in laboratories or strong detergents present in food processing plants, commercial kitchens, slaughter houses, breweries, hospitals, public toilets etc. Available in polished (IL) or brushed (IS) version.

**CURVELINE**

TRIMTEC SR series are also available with a special cut flange so they become formable for curved edges and inlays. To order: add the letter D to the product code – for further details see page 47.



	H/H'=mm		Art.	
Material: Brass	8/15 10/12,5	SR SR	8/15 10/12,5	ON/OL ON/OL
Finish: Natural (ON), Polished (OL)				
Length: 2,70 metres				
Improved anchoring on the vertical side				

Material: Extruded anodised aluminium	8/15 10/12,5	SR SR	8/15 10/12,5	AS AS
Finish: Silver (AS)				
Length: 2,70 metres				
Improved anchoring on the vertical side				

Material: Stainless Steel AISI 304	8/15 10/12,5	SR SR	8/15 10/12,5	IL/IS IL/IS
Finish: Polished (IL), Brushed (IS)				
Length: 2,70 metres				





**STAIRTEC FL** is a technical rounded off stair nosing profile with particular decorative design which helps create a very distinctive feature edge finish to the stair case. The vertical edge trim helps cover cutting imperfections as well to blend into other possible future covering material of the stairs. It truly looks like a "special piece" edge finish yet it is solid and long lasting. Its top grooved surface gives the stair the sufficient safety feature. This profile is suitable for both domestic and commercial environments.

stairtec™ FL

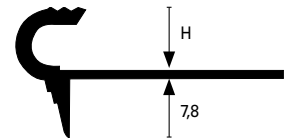

(FL 80\*)

Note: Stainless steel version has a slightly different section

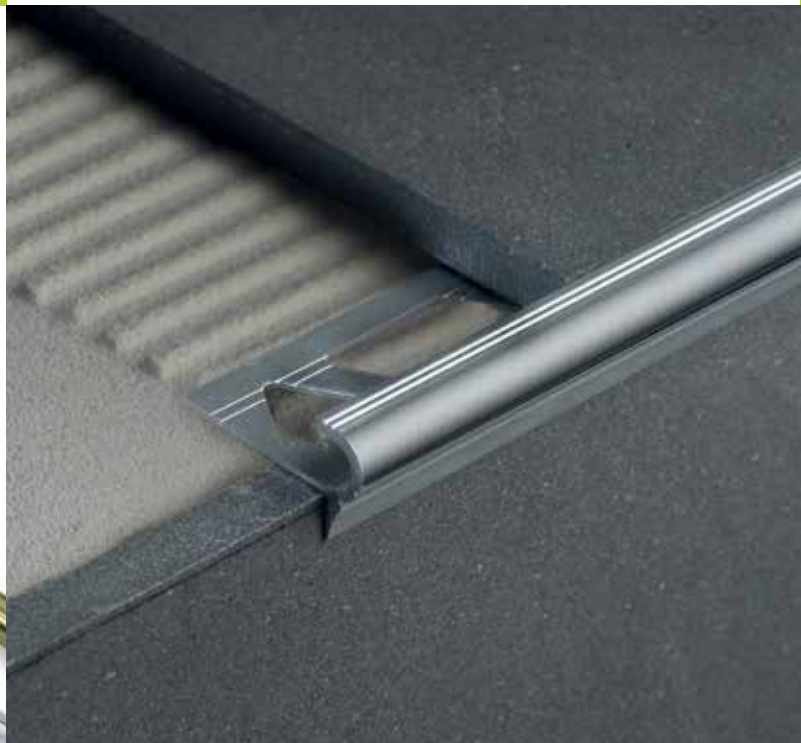
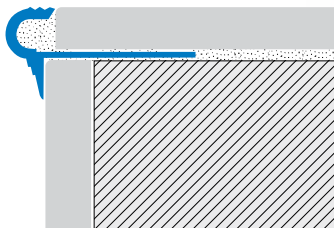

**STAIRTEC FL-O\* Extruded Brass**

This brass profile is developed with prime choice raw material in order to guarantee the tolerance and endurance to chemical and mechanical solicitations. It is primarily applied on both indoor and outdoor floors and can bear intense transit areas as well as for detailing elegant residential coverings. Through contact with moisture or corrosive media, brass may oxidize on exposed surfaces. This situation can be easily solved by buffing the product with a conventional polisher to return to its original shine. Available in natural brass (ON) or polished brass (OL).

**STAIRTEC FL-AS Extruded Anodized Aluminium Silver**

This profile has a silver coating and is suitable for both indoor or outdoor application with high tolerance to weather agents but less to mechanical impact and abrasion. During installation, excess adhesive and grout should be removed immediately to avoid stains.

**STAIRTEC FLR-IL Stainless Steel AISI 304**

Stainless steel profile. Suitable for indoor and outdoor applications. Excellent resistance to corrosion, so it is ideal in the food, chemical and hospital areas and public toilets.

	H=mm		Art.	
Material: Extruded brass	8	FL	80	ON/OL
	10	FL	100	ON/OL
	12,5	FL	125	ON/OL
Finish: Natural (ON), Polished (OL)				
Length: 2,70 metres				

Material: Extruded anodised aluminium	8	FL	80	AS
	10	FL	100	AS
	12,5	FL	125	AS
Finish: Silver (AS)				
Length: 2,70 metres				

Material: Stainless Steel AISI 304	10	FLR	100	IL
	12,5	FLR	125	IL
Finish: Polish (IL)				
Length: 2,70 metres				





**STAIRTEC FL** is a technical stair nosing profile with particular decorative design which helps creating a very distinctive feature edge finish to the stair case. The vertical edge trim helps cover cutting imperfections as well to blend into other possible future covering material of the stairs. It truly looks like a "special piece" edge finish yet it is solid and long lasting. This profile is suitable for both domestic and commercial environments.

stairtec™ FL

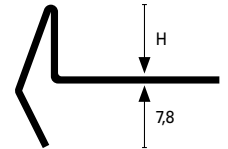

(FL 100\*)

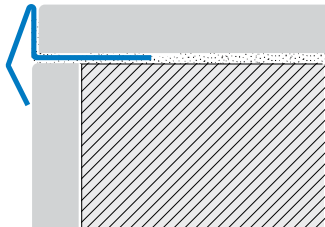

**STAIRTEC FL-IL Polished Stainless Steel AISI 304 - DIN 1.4301**

Stainless steel profile. It ensures very good tolerance to corrosion. Suitable also to contour kitchen tops and shower cubicles.

	H=mm	Art.		
Material:	8	FL	80	IL
Stainless Steel AISI 304	10	FL	100	IL
Finish: Polished (IL)	12,5	FL	125	IL
Length: 2,70 metres				



Profiles in Stainless Steel and Brass with a round section which can be used also as joining edges to the steps of the staircase. Ideal to contour the tiled steps, they perfectly protect the corner edge. Conceived for most domestic and commercial stair coverings purposes. End caps and special pieces available for a perfect job.

## series *RJ - RD*



Stainless steel section



Brass section

(RJ 80I\* - RJ 100O\*)

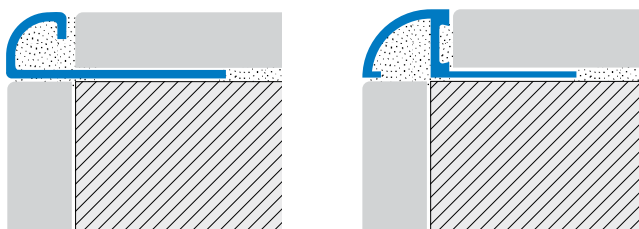

### RoundJolly RJ-IL Stainless Steel AISI 304 DIN 1.4301 / AISI 316 DIN 1.4401

Stainless steel ensures excellent resistance to corrosion, so it is ideal in the food, chemical and hospital areas.

The choice of AISI 316 as standard is suggested for marine environments and in case of exposition to harsher chemical agents.

	H=mm		Art.	
Material: Stainless Steel AISI 304	4,5	RJ	45	IL/IS
Stainless Steel AISI 316 (ILM)	6	RJ	60	IL/IS/ILM
Finish: Polished (IL), Brushed (IS), Sanded (IX)	8	RJ	80	IL/IS/IX/ILM
	10	RJ	100	IL/IS/IX/ILM
Length: 2,70 metres	12,5	RJ	125	IL/IS/IX/ILM
	15	RJ	150	IL/IS

☒ "ultra-thin" line

### Round End caps RJC/I

RJC: External end caps

RJI: Internal end caps

	H=mm		End caps	
Material: Stainless Steel AISI 304	4,5	RJC/I	45	IL/IS
Stainless Steel AISI 316 (ILM)	6	RJC/I	60	IL/IS/ILM
Finish: Polished (IL), Brushed (IS), Sanded (IX)	8	RJC/I	80	IL/IS/IX/ILM
	10	RJC/I	100	IL/IS/IX/ILM
	12,5	RJC/I	125	IL/IS/IX/ILM
	15	RJC	150	IL/IS

### ROUNDTEC RD-ON Extruded brass

Due to the natural properties of brass, it ensures a high tolerance to mechanical impacts and in areas subject to chemical presence. It still contributes to maintain an elegant finish to the coverings applied.

Available in natural brass (ON) or polished brass (OL).

Material:	8	RD	80	ON/OL
Extruded brass	10	RD	100	ON/OL
Finish: Natural (ON), Polished (OL)	12,5	RD	125	ON/OL
	15	RD	150	ON/OL



# squarejolly SJ

Squared section profiles in stainless steel for the protection and finishing of the tiled steps edge from bumps and mechanical impacts. Minimal and modern design. Ideal for domestic and commercial environments. The particular design of SJ profile by Profilitec S.p.a, with the 2 vertical sides directly in touch with the adjacent surface make them suitable also to be used for walking steps and avoid the profile bending.



(SJ 100I\*)

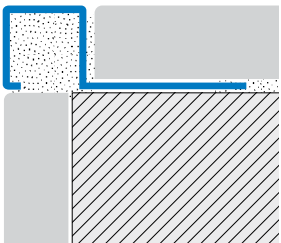

## SQUAREJOLLY SJ-IL Stainless Steel AISI 304 DIN 1.4301 / AISI 316 DIN 1.4401

Stainless steel ensures excellent resistance to most chemicals agents, so it is ideal in the food, chemical and hospital areas.

The choice of AISI 316 as standard is suggested for marine environments and in case of exposition to harsher chemical agents.

## SQUARECAPSULE SJC-IL Stainless Steel

Stainless steel end-caps.

	H=mm		Art.	
Material: Stainless Steel AISI 304	6	SJ	60	IL/IS
Stainless Steel AISI 316 (ILM)	8	SJ	80	IL/IS/IX/ILM
Finish: Polished (IS), Brushed (IS), Sanded (IX)	10	SJ	100	IL/IS/IX/ILM
	12,5	SJ	125	IL/IS/IX/ILM
Length: 2,70 metres	15	SJ	150	IL/IS/ILM

	H=mm		End caps	
Material: Stainless Steel AISI 304	6	SJC	60	IL/IS
Stainless Steel AISI 316 (ILM)	8	SJC	80	IL/IS/IX/ILM
Finish: Polished (IS), Brushed (IS), Sanded (IX)	10	SJC	100	IL/IS/IX/ILM
	12,5	SJC	125	IL/IS/IX/ILM
	15	SJC	150	IL/IS/ILM



# series *RJ - SJM*

Technical and design profiles for finishing stairs using ultra thin tiles. Completing and protecting the steps from mechanical impact. With the **ROUNDJOLLY®** one can achieve a round, safety approved and symmetrical finish. **SQUAREJOLLY SJM** gives a square finish. Ideal for residential and commercial applications.

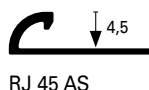

RJ 45 AS

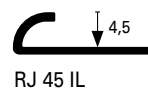

RJ 45 IL

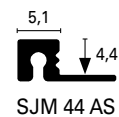

SJM 44 AS

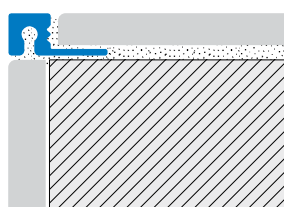
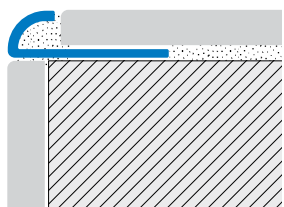

### ROUNDJOLLY® RJ 45 AS Extruded Anodised Aluminium Silver

A silver coated aluminium profile which offers adequate protection and tolerance to wear over time.

### ROUNDJOLLY® RJ 45 I\* Stainless Steel AISI 304 DIN 1.4301

Stainless steel can ensure a high tolerance against most diluted chemical products therefore it is ideal for food industry environments, hospitals and laboratories.

Available in polished (IL) or brushed (IS) version.

### MOSAICTEC SJM 44 AS Extruded Anodised Aluminium Silver

This profile has a silver coating and is suitable for both indoor or outdoor application with high tolerance to weather agents but less to mechanical impact. During installation, excess adhesive and grout should be removed immediately to avoid stains.

	H=mm		Art.		
Material: Extruded anodised aluminium	4,5	RJ	45	AS	☒
Finish: Silver (AS)					
Length: 2,70 metres					
☒ "ultra-thin"line					

Material: Stainless Steel AISI 304	4,5	RJ	45	IL	☒
	4,5	RJ	45	IS	☒
Finish: Polished (IL), Brushed (IS)					
Length: 2,70 metres					
☒ "ultra-thin"line					

Material: Extruded anodised aluminium	4,4	SJM	44	AS	☒
Finish: Silver (AS)					
Length: 2,70 metres					
☒ "ultra-thin"line					





stairtec™ FO

**STAIRTEC FO** is a technical yet elegant stair edging profile suitable for ceramic or wood laying coverings. It is made of solid brass, easy to apply. It is a valid substitute for the "special piece" ceramic nosing which is far more expensive and more subject to breakage. The **STAIRTEC FO** enhances the step edge's elegance with most types of tiles and its top grooved surface gives the stair the sufficient safety feature. This profile is suitable for both domestic and commercial environments. Vertical dovetail anchorage. Patented system.

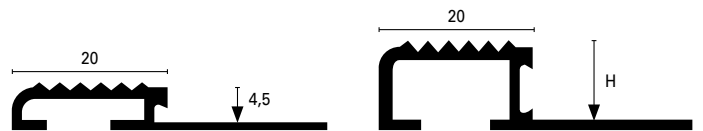

(FO 45\* - FO 100\*)

Note: Stainless steel version has a slightly different section

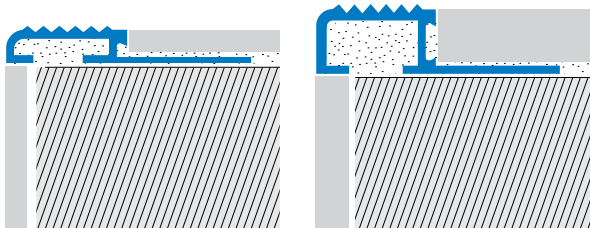

#### STAIRTEC FO-AS Silver Extruded Anodised Aluminium

This profile has an approx. 20 micron silver coating and is suitable for both indoor or outdoor application with high tolerance to weather agents but less to mechanical impact. During installation excess adhesive and grout should be removed immediately to avoid stains. The exposed surface may change colour or darken in time. Where higher stresses are involved the use of brass profiles is recommended.

#### STAIRTEC FO-O\* Extruded Brass

Thanks to the natural properties of brass, it ensures a high tolerance to mechanical impact and in areas subject to chemical presence. It still contributes to maintain an elegant finish to the coverings applied. Through contact with moisture or chemicals brass may oxidize on the exposed surface but the problem is easy to solve by just buffing the profile with a conventional polishing product. Available in natural brass (ON) or polished brass (OL).

#### STAIRTEC FO-IL\* Stainless Steel

Stainless steel profile. Suitable for indoor and outdoor applications. Excellent resistance to corrosion, so it is ideal in the food, chemical and hospital areas and public toilets.

	H=mm	Art.		
Material:	4,5	FO	45	AS
Extruded anodised aluminium	8	FO	80	AS
Finish: Silver (AS)	10	FO	100	AS
	12,5	FO	125	AS
Length: 2,70 metres				
Improved anchoring on the vertical side				
☒ "ultra-thin" line				

Material:	10	FO	100	ON/OL
Extruded Brass	12,5	FO	125	ON/OL
Finish: Natural (ON), Polished (OL)				
Length: 2,70 metres				

Material:	10	FO	100	IL
Stainless Steel AISI 304	12,5	FO	125	IL
Finish: Polish (IL)				
Length: 2,70 metres				



stairtec™ SWP

**Stairtec SWP** is a particular button of the series SWR. Made in stainless steel with a visible protruding part of 5 mm conceived to make obstacles more visible. It is usable in staircases as well as in walkways or dedicated wards.

Installation and assembly can be made in the workshop or directly at the site, by providing a simple hole with a recommended interaxis of 70 mm. Applied to wood, the hole only need to have a diameter of 6,5 mm, then the SWR element can be hammered in. On stairways in marble, stone or ceramic, it is preferable to drill a hole measuring 7 mm and fasten the profile with suitable supporting glue. The grooves will also facilitate the mechanical grip with the part in stainless steel.

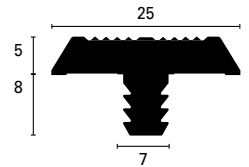

The series SWR is certified R11.  
Anti-slip properties. According to standard DIN 51130 (06/2004).

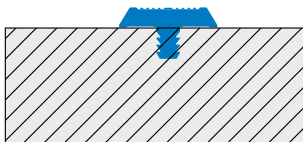

**STAIRTEC SWP 25 IL Polished Stainless Steel AISI 303 DIN 1.4305**

This stainless steel element is AISI 303 standard which ensures high tolerance to most of diluted chemicals found in laboratories or strong detergents present in food processing plants, commercial kitchens, slaughter houses, breweries, hospitals, public toilets etc.  
High mechanical resistance.

	B=mm	Art.		
Materiale: Stainless Steel AISI 303	25	SWP	25	IL
Diameter: 25 mm				





# stairtec™ SWR

**STAIRTEC SWR** non-slip elements with their modern, sophisticated design are an innovative solution to characterize stairways and satisfy safety requisites in an alternative way, rather than using linear profiles.

**STAIRTEC SWR** consists of a narrow button in stainless steel with rounded visible part suitably grooved, that serves to customize stairways in wood or marble with innovative, sophisticated design.

Installation and assembly can be made in the workshop or directly at the site, by providing a simple hole with a recommended interaxis of 70 mm.

Applied to wood, the hole only need to have a diameter of 6,5 mm, then the SWR element can be hammered in. On stairways in marble, stone or ceramic, it is preferable to drill a hole measuring 7 mm and fasten the profile with suitable supporting glue. The grooves will also facilitate the mechanical grip with the part in stainless steel.

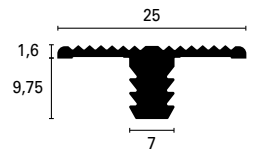

 The series SWR is certified R11. Anti-slip properties. According to standard DIN 51130 (06/2004).



### STAIRTEC SWR 25 IL Polished Stainless Steel AISI 303-DIN 1.4305

Accessorio in Polished Stainless Steel AISI 303, assicura una buona resistenza ai principali prodotti chimici diluiti e ai più comuni detergenti utilizzati in processi alimentari, cucine industriali, macelli, ospedali, toilettes pubbliche. L'elemento in acciaio inox offre un'elevata resistenza meccanica.

	B=mm	Art.		
Materiale: Stainless Steel AISI 303	25	SWR	25	IL
Diameter: 25 mm				





**STAIRTEC SW 10 AS** is an innovative non-slip profile made of anodised aluminium coloured silver, an excellent, long-lasting alternative to common self adhesive carborundum strips.

The reduced "T"-shaped cross-section, with its grooved surface, makes it ideal as an integrated non-slip finish for marble or wooden stairs, creating refined aesthetic effects. It is preferable to cut the slots and install the profile prior to installing the steps .

stairtec™ SW

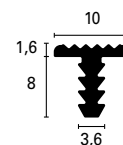

**Installation instructions:**

1. Cut slots measuring 3.5 mm in wood and 4 mm in marble.
2. Make sure the depth of the cuts is at least 9 mm.
3. Fit the STAIRTEC SW 10 AS profile so that it is flush with the step.
4. Simply fitting it in wood stairs will be sufficient; on marble or stone steps use the corroborating glue.

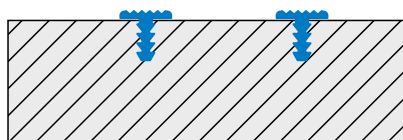

**STAIRTEC SW 10 AS Extruded Anodised Aluminium Silver**

Anodised aluminium profile with a silver coating. It is suitable for both outdoor and/or indoor applications with good tolerance to oxidation.

	H=mm	Art.		
Material: Extruded anodised aluminium	8	SW	10	AS
Finish: Silver (AS)				
Length: 2,70 metres				
Width: 10 mm				





**STAIRTEC SI** is a product engineered to withstand both mechanical impact as well as chemical corrosion and ensures a safety step at the same time, thanks to the carborundum anti-slip strip on its surface, which is to apply after the laying and to be ordered separately. This profile is ideally applied on a pre-laid covering of industrial and/or commercial areas. It is suitable for restructuring jobs for compliance with safety norms. This profile can be either glued or bolted with screws.

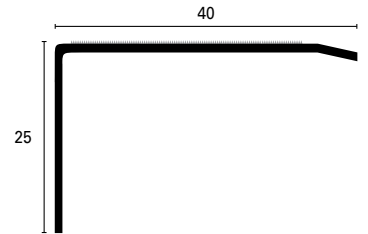

stairtec™ SI



The product SWH is certified R13 (Anti-slip insert).  
Anti-slip properties. According to standard DIN 51130 (06/2004).

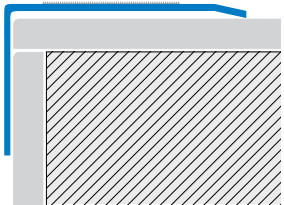

**STAIRTEC SI 400 IL Polished Stainless Steel AISI 304 - DIN 1.4301**

Stainless steel profile, AISI 304 standard, excellent resistance to corrosion, so it is ideal in the food, chemical and hospital areas and public toilets.

Anti-slip strip 25 mm wide not applied to be ordered separately, available in black (C51), transparent (C10) e white (C11).

	BxH	Art.		
Material: Stainless Steel AISI 304	40x25	SI	400	IL
Finish: Polished (IL)				
Length: 2,70 metres				

	mm x m	Art.		
Anti-slip strip black	25x18,3	SWH	25	C51
Anti-slip strip transparent	25x18,3	SWH	25	C10
Anti-slip strip white	25x18,3	SWH	25	C11



When building a staircase we are often faced with the problem of safeguarding the edge of steps which is the most vulnerable area and more subject to wear and tear. STAIRTEC edge profile can cover up damage after the laying, protect as well as replenish the decorative tone of the staircase because it blends well with most covering materials.

For the application of the profile we recommend the use suitable screws and dowels.

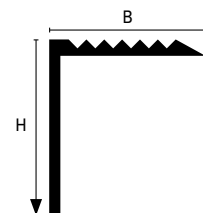

stairtec™ AE

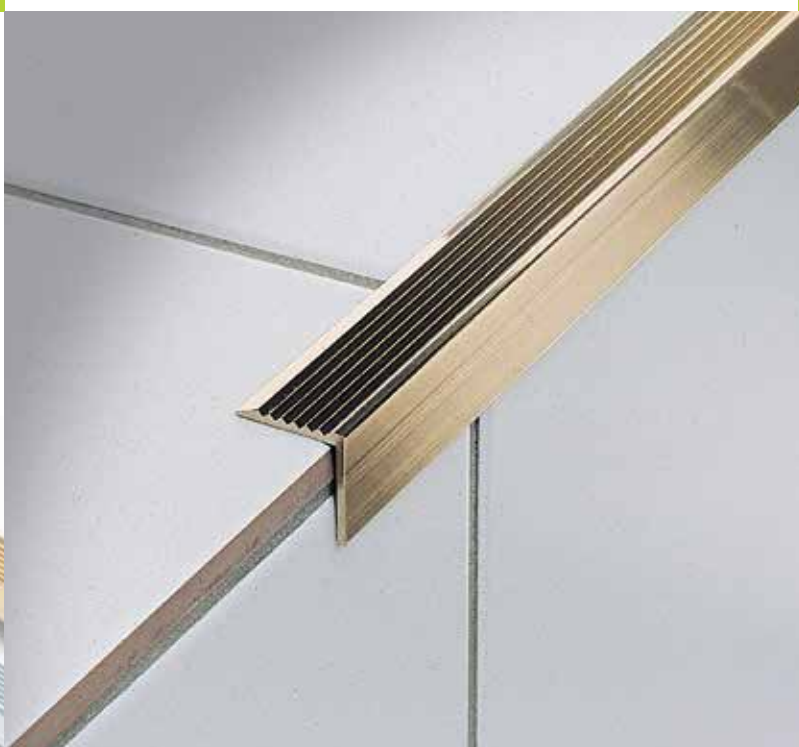
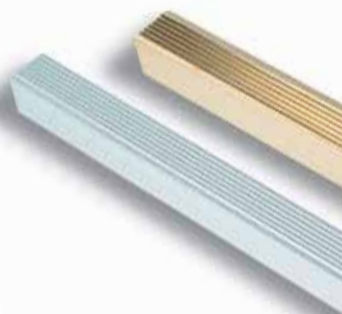
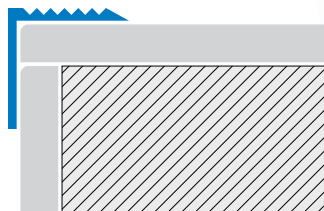

**STAIRTEC AE-OLN Polished Extruded Brass**

Stair nosing profile to apply to finished floors, anti-slip ribbed top surface for safety. To cover and refurbish step edges of staircase. Suitable for intense pedestrian transit.

	BxH	Art.		
Material:	21x21	AE	21	OLN
Extruded brass	30x30	AE	30	OLN
Finish: Polished (OLN)				
Length: 2,70 metres				

**STAIRTEC AE 21 A\*N Extruded anodised aluminium**

Extruded aluminium stair nosing profile available in three standard colour finishes – ideal for steps with limited pedestrian transit. In case of heavier transit we recommend the silver tone finish.

Available in Silver (ASN), Gold (AON) or Bronze finish (ABN).

Material:	21x21	AE	21	ASN
Extruded anodised aluminium	21x21	AE	21	AON
Finish*: Silver (ASN), Gold (AON), Bronze (ABN)	21x21	AE	21	ABN
Length: 2,70 metres				



# stairtec™ SE

**STAIRTEC SE** is an aluminium anodised profile for stairs with a finish coating to apply post laying job. It may be fixed either with screws or adhesive glue. It is meant to satisfy both indoor and outdoor stair nosing situations as it bears high tolerance against oxidation. This profile is developed with a top grooved surface and is also supplied with a chamfered edge to better ensure the safety step. Available in different sizes either with a rounded or blunt corner, it is the ideal solution for refurbishing damaged steps and to cover possible defects of cutting or matching in pre-existing surfaces.

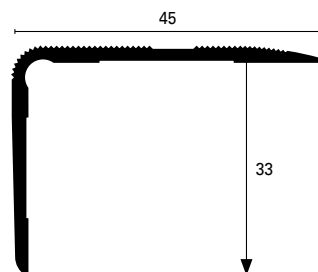
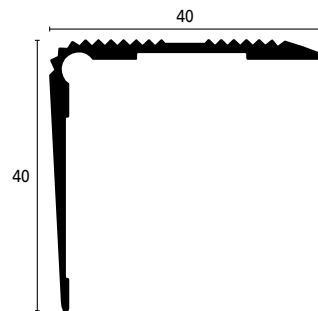
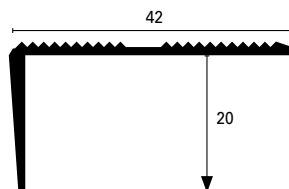

The product SE is certified R11.  
Anti-slip properties. According to standard DIN 51130 (06/2004).

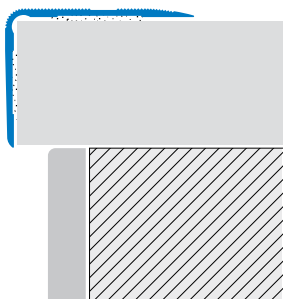

### STAIRTEC SE 40 A\*N Extruded Anodised Aluminium

Symmetric nosing for an elegant and proportioned finish. The grooves on the inferior side ensure an excellent anchoring with the adhesive. For high traffic the silver finish is recommended.

Available in Silver (ASN), Gold (AON) or Bronze finish (ABN).

	BxH	Art.		
Material:	40x40	SE	40	ASN
Extruded anodised aluminium	40x40	SE	40	AON
Finish*: Silver (ASN), Gold (AON), Bronze (ABN)	40x40	SE	40	ABN
Length: 2,70 metres				

### STAIRTEC SE 42 A\*N Extruded Anodised Aluminium

Step edge profile slightly chamfered with detailed top grooved surface. For high traffic installations we recommend to prefer the silver finish.

Available in Silver (ASN), Gold (AON) or Bronze finish (ABN).

Material:	42x22	SE	42	ASN
Extruded anodised aluminium	42x22	SE	42	AON
Finish*: Silver (ASN), Gold (AON), Bronze (ABN)	42x22	SE	42	ABN
Length: 2,70 metres				

### STAIRTEC SE 45 A\*N Extruded Anodised Aluminium

Step edge profile with top surface entirely grooved including chamfered external corner. The internal grooves of the vertical flange enhance the glue grip on the pre-laid covering.

For high traffic installations we recommend to prefer the silver finish. Available in Silver (ASN), Gold (AON) or Bronze finish (ABN).

Material:	45x33	SE	45	ASN
Extruded anodised aluminium	45x33	SE	45	AON
Finish*: Silver (ASN), Gold (AON), Bronze (ABN)	45x33	SE	45	ABN
Length: 2,70 metres				



# stairtec™ SA

**STAIRTEC SA** is a full body aluminium product designed to ensure safety steps thanks to the carborundum anti-slip strip on its surface. This profile is ideal to apply on a pre-laid covering of industrial and/or commercial areas. It is suitable for restructuring jobs for compliance with safety norms. This profile can be either glued - the grooves on the lower side ensuring a perfect anchoring to the adhesive - or bolted with screws, which will be later covered by the carborundum strip.

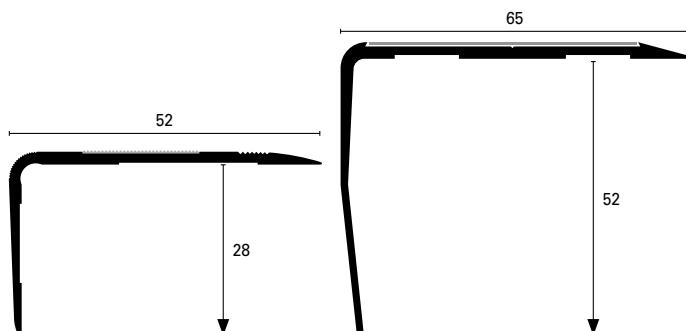

The product SWH is certified R13 (Anti-slip insert).  
Anti-slip properties. According to standard DIN 51130 (06/2004).



### STAIRTEC SA 52 A\*N Extruded anodised aluminium

Anodised aluminium profile, silver, gold or bronze tone. It is suitable for both outdoor and/or indoor applications with good tolerance to oxidation. For high traffic installations we recommend to prefer the silver finish. Anti-slip strip 19 mm wide not applied to be ordered separately, available in black (C 51) or photoluminescent (CF).

	BxH	Art.		
Material:	52x30	SA	52	ASN
Extruded anodised aluminium	52x30	SA	52	AON
Finish*: Silver (ASN), Gold (AON), Bronze (ABN)	52x30	SA	52	ABN
Length: 2,70 metres				

	mm x m	Art.		
Anti-slip strip black	19x18,3	SWH	19	C51
Anti-slip strip fotoluminescente	19x18,3	SWH	19	CF

### STAIRTEC SA 65 ASN Extruded anodized aluminium- silver

Silver anodised aluminium profile. It is suitable for both outdoor and/or indoor applications with good tolerance to oxidation. Black anti-slip strip 50 mm wide (C51)

	BxH	Art.		
Material:	65x55	SA	65	ASN
Extruded anodised aluminium				
Finish: Silver (ASN)				
Length: 2,70 metres				

	mm x m	Art.		
Anti-slip strip black	50x18,3	SWH	50	C51





Safety along with long lasting performance Carborundum quality always stands out in accident prevention measures. WALKTEC is a simply, ready to apply step safe adhesive strip which sticks to any surface. We recommend the double strip application per step in order to ensure a more effective safety action. Before the application of the strips, cut round the tips (see photo) and use a primer where necessary to ensure a better adhesion to the support. The safety strip should be used only on mirror-like surfaces.

# walktec™ SWH



Anti-slip performances, according to DIN 51130 (06/2004) standard.

#### INSTALLATION AND MAINTENANCE:

- 1) Thoroughly wipe off any residue, grease or dirt from the surface and apply primer if so necessary.
- 2) Round off the strip ends.
- 3) Remove the protective paper liner and apply the strip uniformly by press-roll.
- 4) Do not apply strips with temperatures below 15°C unless you have pre-heated the strips themselves and the support.
- 5) Regularly brush off impurities from strips so to maintain best grip texture.
- 6) For installation on smooth tiles, create small strips with rounded ends and apply them in each tile.
- 7) Seal the strips along the edges in order to avoid water infiltration under the strips with their consequent detachment.

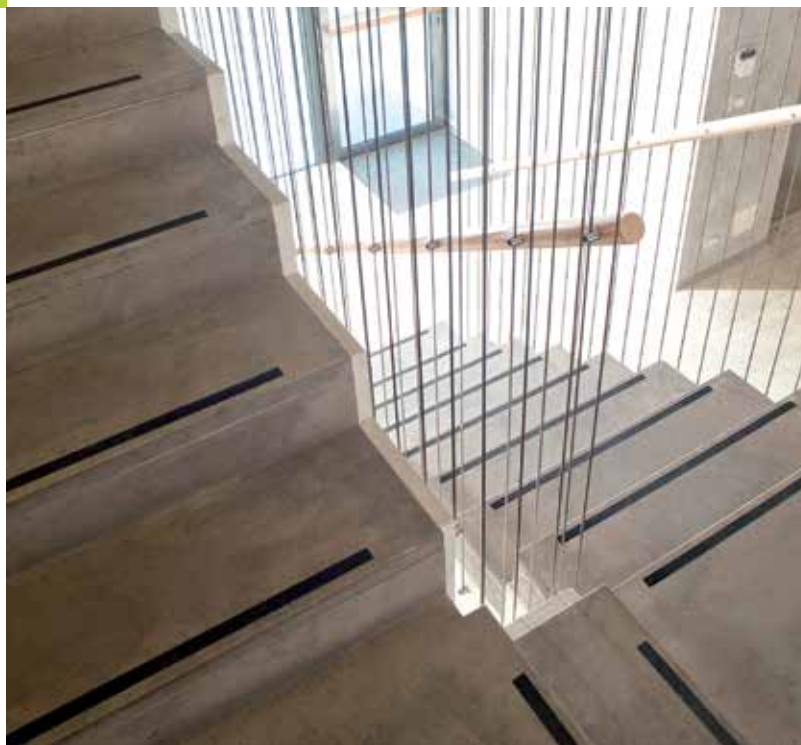

#### WALKTEC SWH Carborundum Self-adhesive Strip

The carborundum strips are made up of a highly compact plastic tape with aggregate granular abrasive polymer for long lasting performance. The adhesive bottom is protected by a paper liner.

WALKTEC is tested for abt.1,3 million walk over pedestrian transit.

With high passage its resistance and performances can be sensibly reduced over the time.

The product is supplied in rolls 18,3 m long ( except SWHS which is sold in 0,61 long strips).

	mm x m	Art.		Colour	
Material: Carborundum	19x18,3	SWH	19	CF	Fluoresc.
	19x18,3	SWH	19	C51	Black
Widths: 19, 25, 50 mm	25x18,3	SWH	25	C51	Black
	25x18,3	SWH	25	C10	Transp.
	25x18,3	SWH	25	C11	White
	50x18,3	SWH	50	C51	Black
	19x0,61	SWHS	19	C51	Black



**STAIRTEC SL** is a corner edge aluminium profile adaptable for all stair coverings and very suitable for wooden ones. The profile is preferred in the domestic environments for it is easy to apply on existing coverings where corner edges need to be as refurbished.

stairtec™ SL

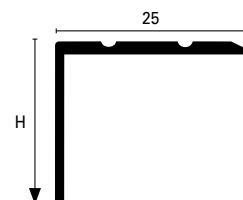

(SL 20\*)

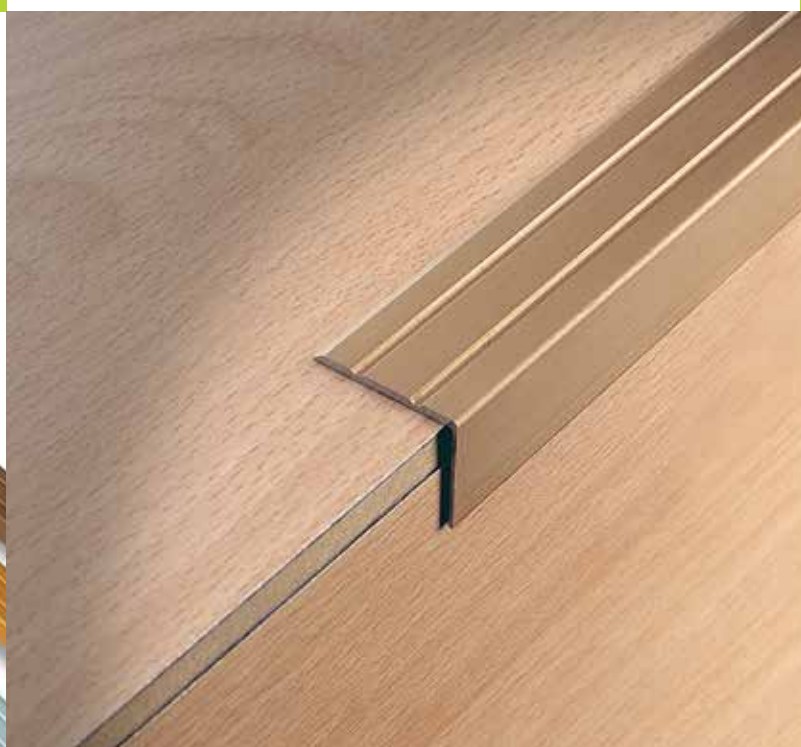
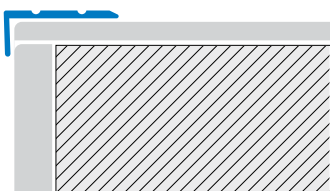

**STAIRTEC SL 10 A\* Extruded Anodised Aluminium**

This anodised aluminium profile is supplied in Silver (AS\*), Gold (AO\*) and Bronze (AB\*) finish. It is tolerant to oxidation but less resistant to mechanical impact. Supplied in the self-adhesive version or with pre drilled holes with screws for DIY installation.

	BxH	Art.		Self-ad.	Drilled
Material:	25x10	SL	10	ASA	ASF
Extruded anodised aluminium	25x10	SL	10	AOA	AOF
Finish*: Silver (AS*), Gold (AO*), Bronze (AB*)	25x10	SL	10	ABA	ABF
Length: 2,70 metres					
: 0,90/1,35 metri					

**STAIRTEC SL 20 A\* Extruded Anodised Aluminium**

Profiles in anodised aluminium available in Silver (ASN), Gold (AON) or Bronze finish (ABN). It is tolerant to oxidation but less resistant to mechanical impact. Supplied in the self-adhesive version or with pre drilled holes with screws for DIY installation.

Material:	25x20	SL	20	ASA	ASF
Extruded anodised aluminium	25x20	SL	20	AOA	AOF
Finish*: Silver (ASF), Gold (AOF), Bronze (ABF)	25x20	SL	20	ABA	ABF
Length: 2,70 metres					
: 0,90/1,35 metri					

Pre-cut length available in SELFLINE kit L= 0,90/1,35 m

**STAIRTEC SL 20\* Extruded Aluminium Wood Cladding Finish**

Profile with a melamine wood tone in 8 different varieties. Good tolerance to abrasion comparable to most melamine coverings. The melamine embossing on the aluminium is particularly smooth therefore it remains quite clean and blends well with the flooring tone.

	Finish	Self-adhesive		Drilled		
Material:	Whitened	SL	20	RSA	SL 20	RSF
Extruded anodised aluminium	Maple	SL	20	ACA	SL 20	ACF
	Beech	SL	20	FAA	SL 20	FAF
	Oak	SL	20	ROA	SL 20	ROF
	Cherry	SL	20	CIA	SL 20	CIF
	Light walnut	SL	20	NCA	SL 20	NCF
	Dark walnut	SL	20	NSA	SL 20	NSF
	Wengé	SL	20	WEA	SL 20	WEF
Length: 2,70 metres						



**STAIRTEC SC** are stair nosing profiles designed for stair coverings in resilient material. Just apply the covering material on the rise of the step and then fix the profiles. Now the tread of the step can be covered with the material so that the finishing work with the profiles ensures the stronghold of the resilient material. The vertical tooth of the profiles over the rise of the step helps further protect the covering material.

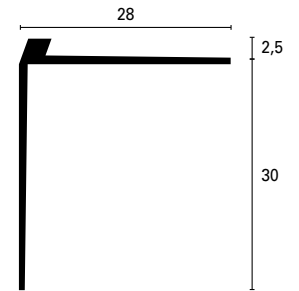

stairtec™ SC

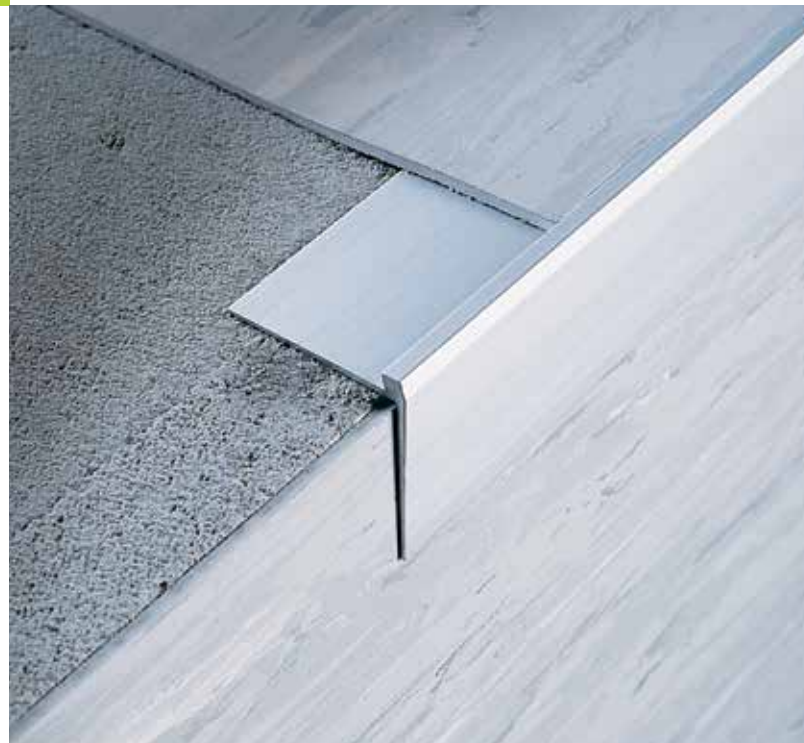

**STAIRTEC SC 30 A\*N Extruded anodised aluminium**

Stair nosing profile for resilient flooring suitable for thicknesses ranging between 2 and 3 mm. Fast and lasting stair step finish.

This anodised aluminium profile is supplied in Silver (ASN), Gold (AON) e Bronze (ABN). It is tolerant to oxidation.

	H1+H	Art.		
Material:	2,5+30	SC	30	ASN
Extruded anodised aluminium	2,5+30	SC	30	AON
Finish*: Silver (ASN), Gold (AON), Bronze (ABN)	2,5+30	SC	30	ABN
Length: 2,70 metres				



**STAIRTEC SM** is a stair nosing profile made in aluminium or brass with an anti-skid rubber grooved or flat smooth insert. It is truly ideal for protection and as a safety measure of stair steps with carpet or rubber covering. The profile can be fixed by screws which are placed within the rubber insert track so that the screws become invisible.

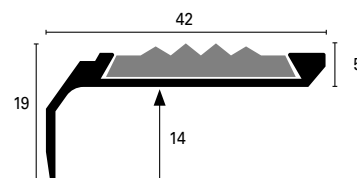

stairtec™ SM

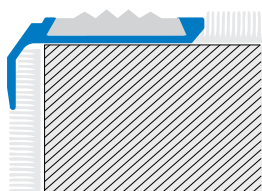

**STAIRTEC SM 14 A\*N Extruded anodised aluminium**

This anodised aluminium profile is supplied in Silver (ASN), Gold (AON) and Bronze (ABN) finish. It is tolerant to oxidation.

Anti-slip insert SMI, SML not included ( see next page).

	BxH	Art.		
Material:	42x14	SM	14	ASN
Extruded anodised aluminium	42x14	SM	14	AON
Finish*: Silver (ASN), Gold (AON), Bronze (ABN)	42x14	SM	14	ABN
Length: 2,70 metres				

**STAIRTEC SM 14 OLN Polished extruded brass**

Solid brass profile, guarantees an excellent resistance to mechanical and chemical impacts, while conveying a long lasting "classic" finish.

Material:	42x14	SM	14	OLN
Extruded brass				
Finish: Polished (OLN)				
Length: 2,70 metres				





**STAIRTEC SM** is a stair nosing profile made in aluminium or brass with an anti-skid rubber grooved or flat smooth insert. It is truly ideal for protection and as a safety measure of stair steps with carpet or rubber covering. The profile can be fixed by screws which are placed within the rubber insert track so that the screws become invisible.

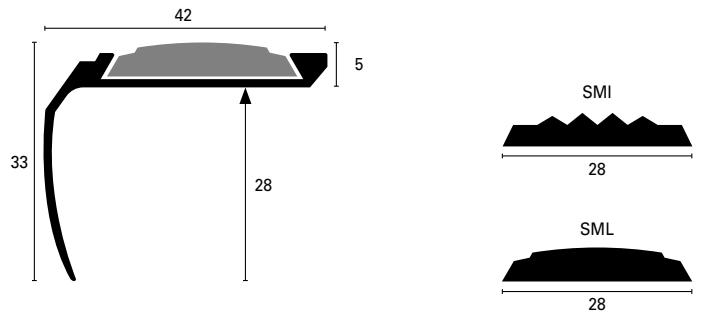

stairtec™ SM

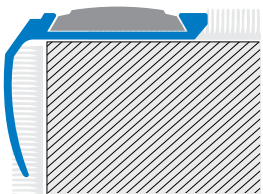

**STAIRTEC SM 28 A\*N Extruded anodised aluminium**

Profiles in anodised aluminium available in Silver (ASN), Gold (AON) or Bronze finish (ABN).

To be installed with the anti-slip infill grooved (SMI) or smooth (SML).

	BxH	Art.		
Material:	42x28	SM	28	ASN
Extruded anodised aluminium	42x28	SM	28	AON
Finish*: Silver (ASN), Gold (AON), Bronze (ABN)	42x28	SM	28	ABN
Length: 2,70 metres				

**STAIRTEC SMI / SML Rubber anti-slip insert**

Synthetic rubber insert – SML for smooth top, SMI for grooved top.

**SMI - Grooved version**

	mm	Art.			Colours
Material: Resinflex	28	SMI	28	P23	Grey
Length: rotoli da 20 m.	28	SMI	28	P32	Dark beige
	28	SMI	28	P51	Black
Width: 28 mm					

**SML - Smooth version**

	mm	Art.			Colours
Material: Resinflex	28	SML	28	P23	Grey
Length: rotoli da 20 m.	28	SML	28	P32	Dark beige
	28	SML	28	P51	Black
Width: 28 mm					







## Wall covering profiles

To join, protect, decorate; these are the functions of this product line.

Fast application, economical solution and lasting performance are the most evident benefits. The application of profiles over the sharp corners is a true safeguarding measure especially to prevent single firing ceramic tiles from chipping. The time saving factor for installing the tile covering is quite relevant when one can avoid the 45° corner cut. The profile will also help the layer for the line-up and the straight vertical edge. There are also numerous solutions for internal corners making them easy to clean as such features are implemented by the current European hygiene and safety standards.

Aluminium, brass, stainless steel and non toxic synthetic materials: over 30 different types of trim finishes enabling the user to coordinate them with tile colours and grout and to create a decorative contrast.

Article		Use	Page
SquareJolly	SJ	multipurpose	102
SquareJolly	SJ	multipurpose	104
FiloJolly	RJF	invisible	105
RoundJolly®	RJ	junction	106
RoundJolly®	RJE	co-extruded profile	108
KeraJolly	KJ	finish	110
Mosaictec	SJM	mosaic	112
Mosaictec	RJM	mosaic	113
Mosaictec	RJF	mosaic	114
TrialJolly	TJ	corner junction	115
Mosaictec	CRM - BT	mosaic	116
Mosaictec	LIM 51	decorative mosaic	117
Mosaictec	LIM 44	decorative mosaic	118
Planotec	BP	work-top edge	119
SquareJolly	SJQ	squared listello	120
Listec	LI 20/LI 22	decorative listello	121
Listec	LI 10	decorative listello	122
Listec	LI 15	decorative listello	123
Listec	LI 10 glitter	glitter listello	124
Listec	LI 15 glitter	glitter listello	125
Listellos	LIA	shim for listellos	126
Appendo	APP 15	vertical listello	127
RoundCorner	RO	round corner protections	128
KeraCorner	CO	corner protectors	129
Sanitec	SB-IL	stainless steel internal cove	130
Sanitec	RS-IL	stainless steel internal cove	131
RoundCorner	RE	corner edge for tiles	132
Sanitec	SB15-IL	junction	133
Coflex	CR	internal co-extruded cove	134
Sanitec	ER	internal co-extruded cove	135
Sanitec	IC	junction	136
InterJolly	IJ	inner corner junction	137
Sanitec	SB	prof. for bath/shower trays	138
Sanitec	SB	methacr. for bath/shower trays	139
Sanitec	SB	multipurpose junction	140

03



**SQUAREJOLLY SJ** is a multipurpose aluminium profile suitable for many different situations arising in thin bed adhesive tile coverings. This special 'symmetrical square' profile is recommended for multiple finishing effects .

The profile inner section has been conceived to match with a special cap **SQUARECAPSULE SJC** which can work as external, internal, three-way junction and end-cap. All these functions with one piece.

squarejolly™ SJ

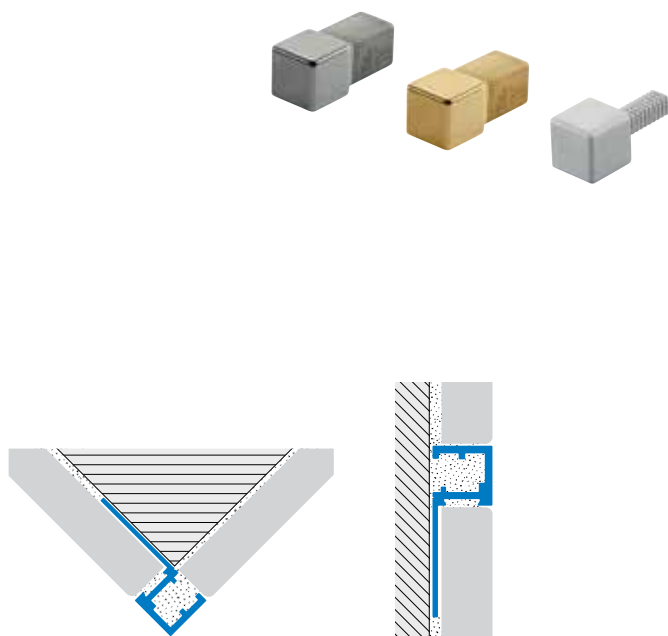
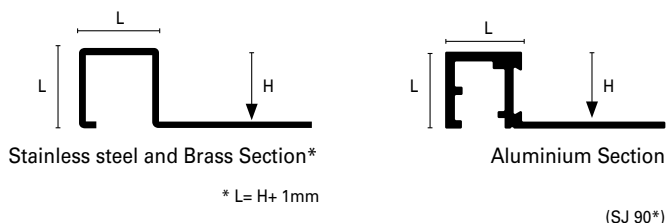

**SQUARECAPSULE SJC-IL Stainless steel**

Stainless steel capsules to make external, internal, three-way junction and end-cap. Its symmetric section allows all these functions with one piece.

	H=mm		Art.	
Material: Stainless steel AISI 304	6	SJC	60	IL/IS
Stainless steel AISI 316 (ILM)	8	SJC	80	IL/IS/IX/ILM
Finish: same finish SJ-I*	9	SJC	90	IL/IS/ILM
	10	SJC	100	IL/IS/IX/ILM
	11	SJC	110	IL/IS/ILM
	12,5	SJC	125	IL/IS/IX/ILM
	15	SJC	150	IL/IS/ILM

**SQUARECAPSULE SJC-O\*Brass**

Brass capsules to make external, internal, three-way junction and end-cap. Its symmetric section allows all these functions with one piece.

Material: Brass	8	SJC	80	OL/OC
	10	SJC	100	OL/OC
	12,5	SJC	125	OL/OC
Finish: same finish SJ-O*				

**SQUARECAPSULE SJC-A\* Aluminium**

Aluminium capsules to make external, internal, three-way junction and end-cap. Its symmetric section allows all these functions with one piece, (minimum quantity required).

Material: Aluminium	6	SJC	60	A*
	8	SJC	80	A*
	9	SJC	90	A*
	10	SJC	100	A*
	11	SJC	110	A*
Finish: same finish SJ-A*	12,5	SJC	125	A*





**SJ profile is a multipurpose profile suitable for a wide range of applications:**

- Junction of floors at the same level
- Decorative listellos
- Finishing the outer edges of wall tiles
- Entrance mat framing
- Upper finish of tiled skirting and edges
- Stair nosing profiles

#### SQUAREJOLLY SJ-IL Polished Stainless steel AISI 304 - DIN 1.4301 e AISI 316

Stainless steel can ensure a high tolerance against most diluted chemical products therefore it is ideal for food industry environments, hospitals and laboratories.

The choice of AISI 316 as standard is suggested for marine environments and in case of exposition to harsher chemical agents.

Available in polished stainless steel (IL), brushed (IS) or sanded (IX).

The sanded finish improves the surface resistance to bumps and scratches with an attractive matt effect.

	H=mm	Art.		
Material: Stainless steel AISI 304	6	SJ	60	IL/IS/ILM
Stainless steel AISI 316 (ILM)	8	SJ	80	IL/IS/IX/ILM
Finish: Polished (IL), Brushed (IS), Sanded (IX)	9	SJ	90	IL/IS/ILM
	10	SJ	100	IL/IS/IX/ILM
	11	SJ	110	IL/IS/ILM
Length: 2,70 metres	12,5	SJ	125	IL/IS/IX/ILM
	15	SJ	150	IL/IS/ILM

#### SQUAREJOLLY SJ Brass

This brass profile is developed with prime choice raw material in order to guarantee tolerance and endurance to chemical and mechanical solicitations. Available also in the polished version Code OL.

Top chrome finishing effect. Resistant to humidity. Great visual impact and good tolerance to mechanical stress.

Available in natural brass (ON) or chromed brass (OC).

Material: Brass	8	SJ	80	OL/OC
Finish: Polished (OL), Chrome (OC)	10	SJ	100	OL/OC
	12,5	SJ	125	OL/OC
Length: 2,70 metres				

#### SQUAREJOLLY SJ-A\* Extruded Anodised Aluminium

A silver (AS) / copper (AR) or titanium (AT) coated aluminium profile which offers adequate protection and tolerance to wear over time.

The surface of this aluminium profile has been Bright anodised on Chrome (ASB), Titanium (ATB) or copper (ARB) effect in order to give that sparkling effect in combination with bathroom ware.

Available also in sanded bright polished Silver (ASXB) or Champagne (ACXB) and in brushed silver (ASS) or bright polished brushed silver (ASSB), for a valuable finish.

Texture options in wooden colours for an elegant and innovative design: whitened oak (ATRS), Wengé (ATWE), Teak (ATTK), Oak (ATTRO).

Material: Extruded anodised aluminium	6	SJ	60	AS/AR/AT/ ASB/ATB/ARB/ ASXB/ASSB/ACXB/ASS/ ATRS/ATWE/ATTK/ATTRO
Finish: Silver (AS), Copper (AR), Titanium (AT), Polished chrome (ASB), Bright polished titanium (ATB), Copper bright polished (ARB), Silver sanded bright polished (ASXB), Silver brushed bright polished (ASSB), Champagne sanded bright polished (ACXB), Silver brushed (ASS), Oak whitened (ATRS), Wengé (ATWE), Teak (ATTK), Oak (ATTRO)	8	SJ	80	AS/AR/AT/ ASB/ATB/ARB/ ASXB/ASSB/ACXB/ASS/ ATRS/ATWE/ATTK/ATTRO
	9	SJ	90	AS/AR/AT/ ASB/ATB/ARB/ ASXB/ASSB/ACXB/ASS/ ATRS/ATWE/ATTK/ATTRO
	10	SJ	100	AS/AR/AT/ ASB/ATB/ARB/ ASXB/ASSB/ACXB/ASS/ ATRS/ATWE/ATTK/ATTRO
Length: 2,70 metres	11	SJ	110	AS/AR/AT/ ASB/ATB/ARB/ ASXB/ASSB/ACXB/ASS/ ATRS/ATWE/ATTK/ATTRO
	12,5	SJ	125	AS/AR/AT/ ASB/ATB/ARB/ ASXB/ASSB/ACXB/ASS/ ATRS/ATWE/ATTK/ATTRO

#### SQUAREJOLLY SJ-A\* Powder coated aluminium

This aluminium profile is lacquered with polyester powder base varnish paint in order to guarantee tolerance against main domestic cleaning products and atmospheric agents as well as UV rays.

On request available in all colours of RJ series page 107. (minimum quantity required).

Material: Powder coated aluminium	8	SJ	80	A*
Finish: Pure White	9	SJ	90	A*
	10	SJ	100	A*
	11	SJ	110	A*
Length: 2,70 metres	12,5	SJ	125	A*



**SQUAREJOLLY SJ** is a multipurpose profile suitable for many different situations arising in thin bed adhesive tile coverings. This special 'symmetrical square' profile is recommended for multiple finishing effects. The profile inner section has been conceived to match with a special cap **SQUARECAPSULE SJC** which can work as external, internal, three-way junction and end-cap. All these functions with one piece.

squarejolly™ SJ

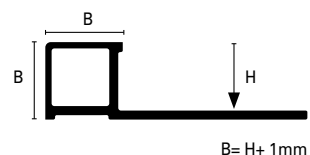

(SJ 80\*)

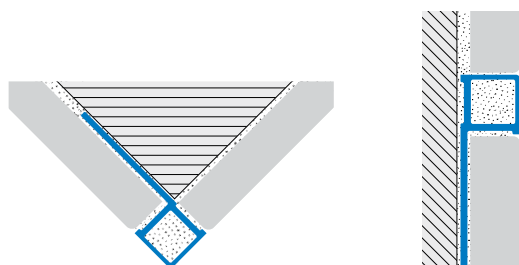

#### SQUAREJOLLY SJ-P Full body coloured Synthetic Resin

The product is entirely of a solid colour compound and not colour coated. This profile is available in a wide range of colours and can be utilized in the most diverse environments which require coverings. This type of trim profile is easy to cut to size so the laying may result quicker and less time consuming therefore one would economize in terms of working over the entire project budget. Again this product maintains a good performance over time against UV rays and small scratches provoked from friction, tolerates impact and chemical agents present in most detergents.

#### SQUAREJOLLY SJ-PM 11 Co-extruded Resin and Methacrylate

Profile in co-extruded resin and visible part in methacrylate. Easy to cut and to apply. It economizes the tiling time ensuring a flawless and long lasting result. The particular material used in modern baths and shower trays offers improved resistance and thanks to its transparency also an improved aesthetic effect.

	Colour	H=6mm	H=8mm	H=10mm
Material:	11= Pure white	SJ 60 P 11	SJ 80 P 11	SJ 100 P 11
Resintop	12= White	SJ 60 P 12	SJ 80 P 12	SJ 100 P 12
Length:	22= Grey	SJ 60 P 22	SJ 80 P 22	SJ 100 P 22
2,70 metres	31= Bahama beige	SJ 60 P 31	SJ 80 P 31	SJ 100 P 31
	41= Cream	SJ 60 P 41	SJ 80 P 41	SJ 100 P 41
	42= Ivory	SJ 60 P 42	SJ 80 P 42	SJ 100 P 42
	51= Black	SJ 60 P 51	SJ 80 P 51	SJ 100 P 51

N.B.: End caps not available

Material:	11= Pure white	SJ 80 PM 11	SJ 100 PM 11
Resintop e PMMA			
Length:			
2,70 metres			

N.B.: End caps not available



filojolly™ RJF

Minimal profile for joining and finishing external corners with an extremely reduced section. An ideal solution where a trim is necessary but a minimalist look is required. Conceived for mitred tiles cut at 45° or for vitreous mosaic H 4,5 mm. The profile shape lends itself to 'countersunk' design of the edge, therefore protecting the fragile edges. A simple design for maximum results.

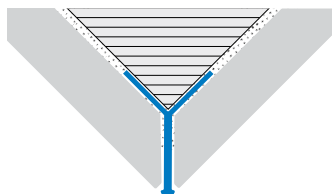
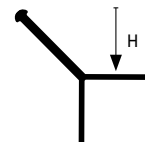

**FILOJOLLY RJF-AS Extruded Anodised Aluminium**

A silver (AS) coated aluminium profile which offers adequate protection and tolerance to wear over time.

The surface of this anodised aluminium profile has been chrome-effect treated in order to give that sparkling effect in combination with bathroom ware.

	H=mm	Art.		
Material:	4,4	RJF	44	AS/ASB
Extruded anodised aluminium	6	RJF	60	AS/ASB
Finish: Silver (AS),	8	RJF	80	AS/ASB
Polished chrome (ASB)	10	RJF	100	AS/ASB
Length: 2,70 metres				
☒ "thin" line				



The ROUNDJOLLY® profile perfects and protects the external sharp corners leaving a pleasant aesthetic finish to the wall. The corner of the wall is well protected from impact and the edge being rounded off, thanks to the ROUNDJOLLY® circle section, is less dangerous in case one should accidentally hit it.

roundjolly® RJ



Stainless steel and Brass Section



Aluminium and PVC Section

(RJ 80\*)

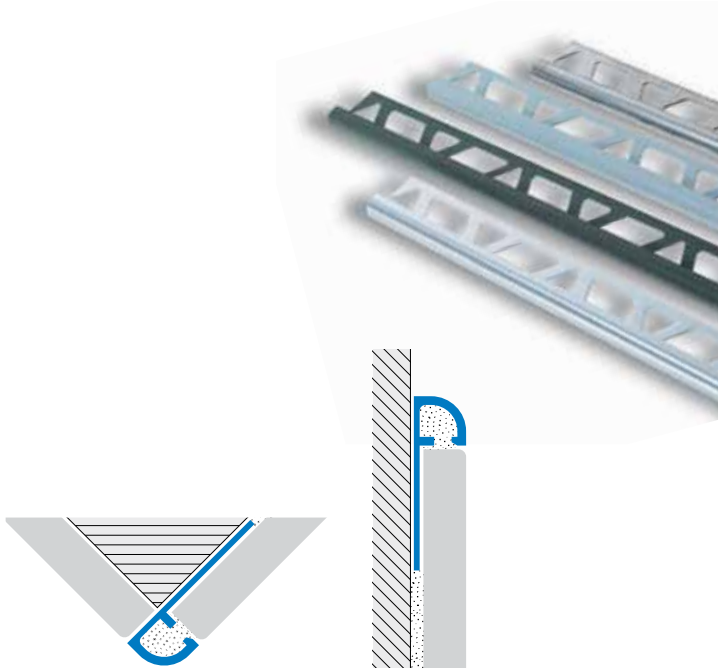

**ROUNDJOLLY® RJ-I\* Stainless steel AISI 304 - DIN 1.4301 and AISI 316**

Stainless steel can ensure a high tolerance against most diluted chemical products therefore it is ideal for food industry environments, hospitals and laboratories. The AISI 316 (code ILM) choice is recommended as standard for salty or aggressive environments. Available in the polished version, (IL), brushed, (IS) and sanded, (IX) (H 8,10,12,5)\* - RJ 45: different section.

**ROUNDJOLLY® RJ-OC Chromed Brass**

Brass profile with top chrome (OC) finishing effect. Resistant to humidity. Great visual impact and good tolerance to mechanical stress.

**ROUNDJOLLY® RJ-A\* Anodised Aluminium**

Silver (AS), gold (AO), copper (AR) or titanium (AT) coated aluminium profile which offers adequate protection and tolerance to wear over time.

The surface of this aluminium profile has been bright anodised on chrome (ASB), titanium (ATB), gold (AOB) or copper (ARB) effect in order to give that sparkling effect in combination with bathroom ware. It holds the same properties as the other aluminium models.

	H=mm		Art.	
Material: Stainless steel AISI 304	4,5	RJ	45	IL/IS/ILM
Stainless steel AISI 316 (ILM)	6	RJ	60	IL/IS/ILM
Finish: Polished (IL), Brushed (IS), Sanded (IX)	8	RJ	80	IL/IS/IX/ILM
	10	RJ	100	IL/IS/IX/ILM
Length: 2,70 metres	12,5	RJ	125	IL/IS/IX/ILM
	15	RJ	150	IL/IS
☒ "thin" line				

Material: Brass	6	RJ	60	OC
	8	RJ	80	OC
Finish: Chrome (OC)	10	RJ	100	OC
	12,5	RJ	125	OC
Length: 2,70 metres				

Material: Extruded anodised aluminium	4,5	RJ	45	AS/ASB
Finish: Silver (AS), Gold (AO), Copper (AR), Titanium (AT), Polished chrome (ASB), Bright polished titanium (ATB), Bright polished gold (AOB), Copper bright polished (ARB)	6	RJ	60	AS/AO/AR/AT/ASB/ATB/AOB/ARB
	8	RJ	80	AS/AO/AR/AT/ASB/ATB/AOB/ARB
	10	RJ	100	AS/AO/AR/AT/ASB/ATB/AOB/ARB
Length: 2,70 metres	12,5	RJ	125	AS/AO/AR/AT/ASB/ATB/AOB/ARB
☒ "thin" line				





Wall section where the application of the jointing RJ capsule for the profile trim finish is evident.

Other applications may be: top skirting finish (as seen in diagram) or edging of tile covering, natural stone or limestone as well as for moquette carpeting. To ensure a perfect grip, the profile trim must be completely filled all within the cavity with the grout for layers.

### ROUNDJOLLY® RJ-A\* Extruded Powder Coated Aluminium

This aluminium profile is lacquered with polyester powder base varnish paint in order to guarantee tolerance against main domestic cleaning products and atmospheric agents as well as UV rays. The profiles perform in endurance and elasticity for one may find a not so straight wall during the installation. The profile is entirely varnished also within its flange.

	Colour	H=4,5mm	H=6mm	H=8mm
Material: Powder coated aluminium	11= Pure white	RJ 45 A 11	RJ 60 A 11	RJ 80 A 11
	12= White	RJ 45 A 12	RJ 60 A 12	RJ 80 A 12
	13= Rustic white		RJ 60 A 13	RJ 80 A 13
	21= Light grey	RJ 45 A 21	RJ 60 A 21	RJ 80 A 21
	22= Grey	RJ 45 A 22	RJ 60 A 22	RJ 80 A 22
	23= Cement grey	RJ 45 A 23	RJ 60 A 23	RJ 80 A 23
	31= Bahama beige	RJ 45 A 31	RJ 60 A 31	RJ 80 A 31
	32= Dark beige	RJ 45 A 32	RJ 60 A 32	RJ 80 A 32
	41= Cream	RJ 45 A 41	RJ 60 A 41	RJ 80 A 41
	42= Ivory	RJ 45 A 42	RJ 60 A 42	RJ 80 A 42
	51= Black	RJ 45 A 51	RJ 60 A 51	RJ 80 A 51
Length: 2,70 metres				
"thin" line				

	Colour	H=10mm	H=12,5mm
Material: Powder coated aluminium	11= Pure white	RJ 100 A 11	RJ 125 A 11
	12= White	RJ 100 A 12	RJ 125 A 12
	13= Rustic white	RJ 100 A 13	RJ 125 A 13
	21= Light grey	RJ 100 A 21	
	22= Grey	RJ 100 A 22	RJ 125 A 22
Length: 2,70 metres	23= Cement grey	RJ 100 A 23	
	31= Bahama beige	RJ 100 A 31	RJ 125 A 31
	32= Dark beige	RJ 100 A 32	
	41= Cream	RJ 100 A 41	
	42= Ivory	RJ 100 A 42	
51= Black	RJ 100 A 51		
"thin" line			

### ROUNDJOLLY® RJ-P\* Full body coloured Synthetic Resin

The product is entirely of a solid colour compound and not colour coated. This profile is available in a wide range of colours and can be utilized in the most diverse environments which require coverings. This type of trim profile is easy to cut to size so the laying may result quicker and less time consuming therefore one would economize in terms of working over the entire project budget.

Again this product maintains a good performance over time against UV rays and small scratches provoked from friction, tolerates impact and chemical agents present in most detergents.

	Colour	H=6mm	H=8mm	H=10mm
Material: Resintop	11= Pure white	RJ 60 P 11	RJ 80 P 11	RJ 100 P 11
	12= White	RJ 60 P 12	RJ 80 P 12	RJ 100 P 12
	21= Light grey	RJ 60 P 21	RJ 80 P 21	RJ 100 P 21
	22= Grey	RJ 60 P 22	RJ 80 P 22	RJ 100 P 22
	23= Cement grey	RJ 60 P 23	RJ 80 P 23	RJ 100 P 23
	31= Bahama beige	RJ 60 P 31	RJ 80 P 31	RJ 100 P 31
	32= Dark beige	RJ 60 P 32	RJ 80 P 32	RJ 100 P 32
	41= Cream	RJ 60 P 41	RJ 80 P 41	RJ 100 P 41
	42= Ivory	RJ 60 P 42	RJ 80 P 42	RJ 100 P 42
	43= Peach	RJ 60 P 43	RJ 80 P 43	RJ 100 P 43
	44= Light Pink	RJ 60 P 44	RJ 80 P 44	RJ 100 P 44
Length: 2,70 metres	45= Light Blue	RJ 60 P 45	RJ 80 P 45	RJ 100 P 45
	46= Light green	RJ 60 P 46	RJ 80 P 46	RJ 100 P 46
	51= Black	RJ 60 P 51	RJ 80 P 51	RJ 100 P 51

### ROUNDCAPSULE RJC and RJI

End caps for the profiles ROUNDJOLLY® series. They can perfectly connect 2 or 3 axis.

Available external end caps Code RJC and internal ones Code RJI.

Available also end caps RJC-A and RJI-A in Aluminium with an imitation Polished Stainless steel finish.

	H=mm	Plastic	Aluminium	Stainless Steel	Chromed Brass
Material: Plastic, Powder Coated Aluminium, Anodised Aluminium, Stainless steel Polished brushed, Sanded	4,5		RJC 45 A*	RJC 45 IL/IS	
	6	RJC/ 60 P*	RJC/ 60 A*	RJC/ 60 IL/IS/ILM	RJC 60 OC
	8	RJC/ 80 P*	RJC/ 80 A*	RJC/ 80 IL/IS/IX/ILM	RJC 80 OC
	10	RJC/ 100 P*	RJC/ 100 A*	RJC/ 100 IL/IS/IX/ILM	RJC 100 OC
	125	RJC/ 125 P*	RJC/ 125 A*	RJC/ 125 IL/IS/IX/ILM	RJC 125 OC
15			RJC 150 IL/IS		
Colours* : as per matching RJ profiles					



roundjolly® RJE

This is the closed section profile trim from the **ROUNDJOLLY®** family developed with co-extrusion technology joining two polymer synthetic resin elements. The closed section length enables the layer to line up the ceramic tile readily on the wall. New colours are available including a very realistic marble tone effect. This popular tile profile prevents the cracking of the sharp corner while perfectly rounding off the edge always with a symmetric laying job.



(RJE 80\*)

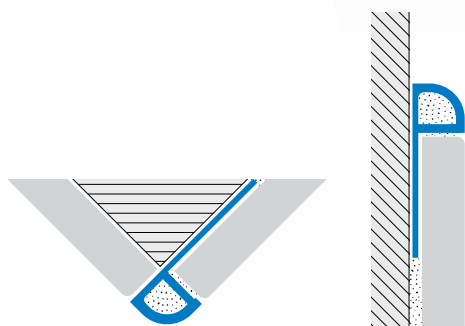
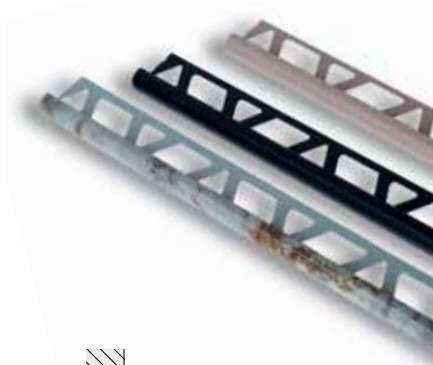

**ROUNDJOLLY® RJE Co-extruded**

The exclusive manufacturing system used to produce the RJE series of profiles allows the simultaneous extrusion of two different resin polymers, granting a total and independent control over both the visible surface and the anchoring flange.

This ensures the maximum performances of endurance and mechanical resistance while still providing a high quality appearance.





Wall section where the application of the jointing RJC capsule for the profile trim finish is evident.

Other applications may be: top skirting finish (as seen in diagram) or edging of tile covering, natural stone or limestone as well as for moquette carpeting.

#### ROUNDJOLLY® RJE-P Full body coloured Synthetic Resin

The product is entirely of a solid colour compound and not colour coated. The profile is available in a wide range of colours and can be utilized in the most diverse environments which require coverings. This type of trim profile is easy to cut to size so the laying may result quicker and less time consuming therefore one would economize in terms of labour over the entire project budget.

This product maintains good performance over time against UV rays and small scratches are not so visible, tolerates impact and chemicals present in most detergents.

	Colour	H=6mm			H=8mm		
Material:	11= Pure white	RJE	60	P 11	RJE	80	P 11
Resintop	22= Grey	RJE	60	P 22	RJE	80	P 22
Length:	31= Bahama beige	RJE	60	P 31	RJE	80	P 31
2,70 metres							
	Colour	H=10mm			H=12,5mm		
Material:	11= Pure white	RJ	100	P 11	RJE	125	P 11
Resintop	22= Grey	RJ	100	P 22	RJE	125	P 22
Length:	31= Bahama beige	RJ	100	P 31	RJE	125	P 31
2,70 metres							

#### ROUNDJOLLY® RJE-PT BRILCOLOUR LINE Synthetic Resin

Co-extruded profiles coated with hot laminate decorative film for the "shiny effect" in order to satisfy a more particular laying job. The more delicate tone finish makes this tile trim profile most suitable for domestic applications.

	Colour	H=6mm		H=8mm		H=10mm	
Material:	11= Pure white	RJE	60	PT 11	RJE	80	PT 11
Resintop	12= White	RJE	60	PT 12	RJE	80	PT 12
Length:	22= Grey	RJE	60	PT 22	RJE	80	PT 22
2,70 metres	31= Bahama beige	RJE	60	PT 31	RJE	80	PT 31

#### ROUNDJOLLY® RJS-P\* MARBLE Line Synthetic Resin

Profiles hot coated with "marble effect" tone reproduction of the most requested marble tones in commerce. The more delicate finish makes this tile trim profile most suitable for domestic applications.

	Colour	H=9mm			H=11mm		
Material:	82= White marble	RJS	90	P 82	RJS	110	P 82
Resintop	83= Light travertino	RJS	90	P 83	RJS	110	P 83
	84= Beige travertino	RJS	90	P 84	RJS	110	P 84
	85= Marble navona	RJS	90	P 85	RJS	110	P 85
	86= Beige Pink	RJS	90	P 86	RJS	110	P 86
	87= Beige yellow	RJS	90	P 87	RJS	110	P 87
	88= Beige caramel	RJS	90	P 88	RJS	110	P 88
Length:	89= Dove beige	RJS	90	P 89	RJS	110	P 89
2,60 metres	90= Antique pink	RJS	90	P 90	RJS	110	P 90
	91= Peach pink	RJS	90	P 91	RJS	110	P 91
	92= Light green	RJS	90	P 92	RJS	110	P 92
	93= Brazil green	RJS	90	P 93	RJS	110	P 93
	94= Azure blue	RJS	90	P 94	RJS	110	P 94
	95= Grey avio	RJS	90	P 95	RJS	110	P 95
	96= Stone grey	RJS	90	P 96	RJS	110	P 96

#### ROUNDCAPSULE RJC e RJI

End caps for the profiles ROUNDJOLLY® series. They can perfectly connect 2 or 3 axis. Available external end caps Code RJC and internal ones Code RJI.

	H=mm	Plastic	
Material:	6	RJC/I	60 P*
Plastic	8	RJC/I	80 P*
Colours: The same as per matching RJE profiles**	10	RJC/I	100 P*
	12,5	RJC/I	125 P*

\*\*\*\* Marble line excluded (end caps not available)



KERAJOLLY profiles are utilized to define the sharp external wall corners during tile laying. They protect the more fragile single firing tile edges or borders. KERAJOLLY allows the layer to execute his work rapidly and precisely with the only task of choosing the proper size of the profile in respect to the thickness of the tile.

kerajolly™ KJ

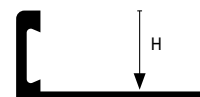

(TR 100\* - KS 100\*)

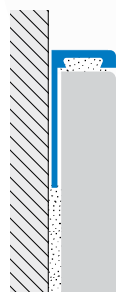
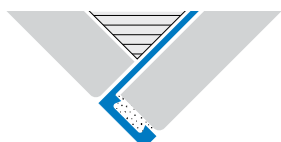
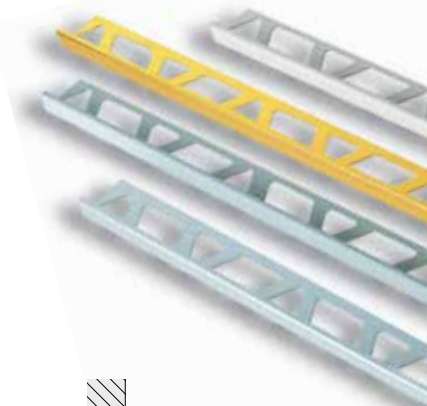

#### KERAJOLLY TR-I\* Stainless steel AISI 304 - DIN 1.4301 e AISI 316

Stainless steel is the best product to ensure resistance against corrosion and for hygienic purposes. The choice of the AISI 316 quality is most appropriate for salty environments or swimming pools.

Available in top-brushed effect finish, code IS.

Available in polished stainless steel (IL), brushed (IS) or sanded (IX).

	H=mm		Art.		
Material: Stainless steel AISI 304	4,5	TR	45	IL/IS	☒
Stainless steel AISI 316 (ILM)	6	TR	60	IL/IS/ILM	
Finish: Polished (IL), Brushed(IS), Sanded (IX)	8	TR	80	IL/IS/ILM	
	10	TR	100	IL/IS/IX/ILM	
	12,5	TR	125	IL/IS/IX/ILM	
Length: 2,70 metres					
☒ "thin" line					

#### KERAJOLLY TR-KJ A\*Silver Anodised Aluminium

A silver (TR/AS) coated aluminium profile which offers an adequate corner edge protection. Granting protection against the aluminium corrosive agents.

The surface of this anodised aluminium profile has been chrome (KJ\*\*ASB) or gold-effect (KJ\*\*ADB) treated in order to give that sparkling effect in combination with bathroom ware. It holds the same properties as the other aluminium models.

Material:	2	TR	20	AS	KJ			☒
Extruded anodised aluminium	3	TR	30	AS	KJ			
Finish: Silver (AS), Polished chrome (ASB), Bright polished gold (AOB)	4,5	TR	45	AS	KJ			
	6	TR	60	AS	KJ	60	ASB/AOB	
	8	TR	80	AS	KJ	80	ASB/AOB	
Length: 2,70 metres	10	TR	100	AS	KJ	100	ASB/AOB	
	12,5	TR	125	AS	KJ	125	ASB/AOB	
☒ "thin" line								





**KERAJOLLY** profiles protect ceramic tiled wall corners against impact while allowing the decorator to blend in with the colour combination, thanks to the extensive colour variety. Furthermore, one can match the different colours available with the **LISTEC** listello. **KERAJOLLY** ensures the least visible trimming but still guaranteeing the safety and endurance characteristics which are expected in a laying job.

**KERAJOLLY KJ-A\* Powder Coated Aluminium**

This aluminium profile is lacquered with polyester powder base varnish paint in order to guarantee tolerance against main domestic cleaning products and atmospheric agents as well as UV rays. The profiles perform in endurance and elasticity for one may find a not so straight wall during the installation. The profile is entirely varnished also within its cavity.

	Colour	H=6mm		H=8mm	
Material: Powder coated aluminium	11= Pure white	KJ 60	A 11	KJ 80	A 11
	12= White	KJ 60	A 12	KJ 80	A 12
	21= Light grey	KJ 60	A 21	KJ 80	A 21
	22= Grey	KJ 60	A 22	KJ 80	A 22
	23= Cement grey	KJ 60	A 23	KJ 80	A 23
	31= Bahama beige	KJ 60	A 31	KJ 80	A 31
	32= Dark beige	KJ 60	A 32	KJ 80	A 32
	41= Cream	KJ 60	A 41	KJ 80	A 41
	42= Ivory	KJ 60	A 42	KJ 80	A 42
	51= Black	KJ 60	A 51	KJ 80	A 51
Length: 2,70 metres					

	Colour	H=10mm		H=12,5mm	
Material: Powder coated aluminium	11= Pure white	KJ 100	A 11	KJ 125	A 11
	12= White	KJ 100	A 12	KJ 125	A 12
	21= Light grey	KJ 100	A 21	KJ 125	A 21
	22= Grey	KJ 100	A 22	KJ 125	A 22
	23= Cement grey	KJ 100	A 23	KJ 125	A 23
	31= Bahama beige	KJ 100	A 31	KJ 125	A 31
	32= Dark beige	KJ 100	A 32	KJ 125	A 32
	41= Cream	KJ 100	A 41	KJ 125	A 41
	42= Ivory	KJ 100	A 42	KJ 125	A 42
	51= Black	KJ 100	A 51	KJ 125	A 51
Length: 2,70 metres					

**KERAJOLLY KJ-P\* Full body coloured Synthetic Resin**

The product is entirely of a solid colour compound and not colour coated. The profile is available in a wide range of colours and can be utilized in the most diverse environments which require coverings. This type of trim profile is easy to cut to size so the laying may result quicker and less time consuming therefore one would economize in terms of labour over the entire project budget.

Again this product maintains a good performance over time against UV rays and small scratches are not so visible, tolerates impact and chemicals present in most detergents.

	Colour	H=6mm		H=8mm	
Material: Resintop	11= Pure white	KJ 60	P 11	KJ 80	P 11
	12= White	KJ 60	P 12	KJ 80	P 12
	21= Light grey	KJ 60	P 21	KJ 80	P 21
	22= Grey	KJ 60	P 22	KJ 80	P 22
	23= Cement grey	KJ 60	P 23	KJ 80	P 23
	31= Bahama beige	KJ 60	P 31	KJ 80	P 31
	32= Dark beige	KJ 60	P 32	KJ 80	P 32
	41= Cream	KJ 60	P 41	KJ 80	P 41
	42= Ivory	KJ 60	P 42	KJ 80	P 42
	51= Black	KJ 60	P 51	KJ 80	P 51
Length: 2,70 metres					

	Colour	H=10mm		H=12,5mm	
Material: Resintop	11= Pure white	KJ 100	P 11	KJ 125	P 11
	12= White	KJ 100	P 12	KJ 125	P 12
	21= Light grey	KJ 100	P 21	KJ 125	P 21
	22= Grey	KJ 100	P 22	KJ 125	P 22
	23= Cement grey	KJ 100	P 23	KJ 125	P 23
	31= Bahama beige	KJ 100	P 31	KJ 125	P 31
	32= Dark beige	KJ 100	P 32	KJ 125	P 32
	41= Cream	KJ 100	P 41	KJ 125	P 41
	42= Ivory	KJ 100	P 42	KJ 125	P 42
	51= Black	KJ 100	P 51	KJ 125	P 51
Length: 2,70 metres					

**KERAJOLLY KJ-OC Chromed Brass**

Brass profile with top chrome finishing effect (OC). Resistant to humidity and corrosion. Great visual impact and good tolerance to mechanical stress. This profile is highly suitable to match with bathroom accessories.

	H=mm		Art.	
Material: Chromed Brass Extruded	6	KJ	60	OC
	8	KJ	80	OC
	10	KJ	100	OC
	12,5	KJ	125	OC
Length: 2,70 metres				



mosaic<sup>+</sup>tec™ SJM

Squarejolly range specifically developed for mosaic. Multipurpose profile used either to create external corners, to finish edges or as a decorative listello. Ideal for most types of installation, the profile provides neat edge finishing with equal visible sides.

The profile is available with a universal cube-shaped end cap to be used as internal, external and three-way junction.

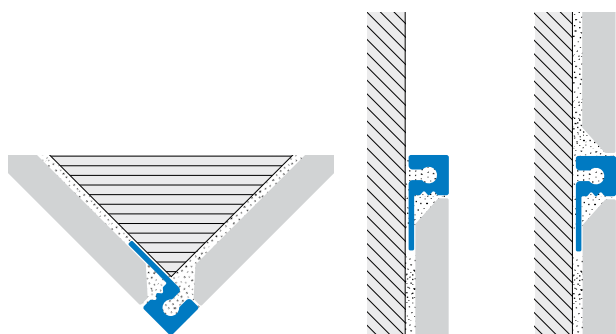
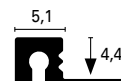

**MOSAICTEC SJM 44 A\* Anodised Aluminium**

An silver coated aluminium (AS) profile which offers adequate protection and tolerance to wear over time.

The surface of this anodised aluminium (ASB) profile has been chrome-effect treated in order to give that sparkling effect in combination with bathroom ware. The shiny gold finish effect (AOB) is also requested for particular combination in interior decorating design. Also this profile holds the same properties as the other aluminium models.

**MOSAICTEC SJC 44 A\* End cap Aluminium**

Capsules to make external, internal, three-way junction and end-cap. The profile symmetric section has been conceived to match all these functions with one piece.

	H=mm		Art.	
Material: Extruded anodised aluminium	4,4	SJM	44	AS/ASB/AOB
Finish: Silver (AS), Polished chrome (ASB), Bright polished gold (AOB)				
Length: 2,70 metres				
☒ "thin" line				

	H=mm		Art.	
Material: Extruded Aluminium	4,4	SJC	44	AS/ASB/AOB
Finish: Silver (AS), Polished chrome (ASB), Bright polished gold (AOB)				
Length: 2,70 metres				
☒ "thin" line				



mosaic<sup>+</sup>tec™ RJM

Jolly profile with the new 'X' design for an improved mechanical fixing of the vitreous mosaic tesseras.

The visible element is symmetrically rounded and can be used for the protection of corners and stair nosings. Designed specifically for the perfect installation of vitreous mosaic, with a thickness of approx 4mm and a 20mm x 20mm format.

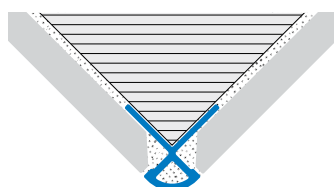
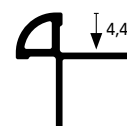

**MOSAICTEC RJM 44 A\* Anodised Aluminium**

A silver coated aluminium (AS) profile which offers adequate protection and tolerance to wear over time.

The surface of this anodised aluminium profile has been chrome-effect (ASB) treated in order to give that sparkling effect in combination with bathroom ware. The shiny gold finish effect is also requested for particular combination in interior decorating design.

	H=mm	Art.		
Material: Extruded anodised aluminium	4,4	RJM	44	AS/ASB/AOB
Finish: Silver (AS), Polished chrome (ASB), Bright polished gold (AOB)				
Length: 2,70 metres				
"thin" line				



mosaictec™ RJF

Functional profile for joining and finishing external corners with an extremely reduced section. An ideal solution where a trim is necessary but a minimalist look is required.

The profile shape lends itself to 'countersunk' design of the edge of the tessera, therefore protecting the fragile edges of the mosaic.

A simple design for maximum results.

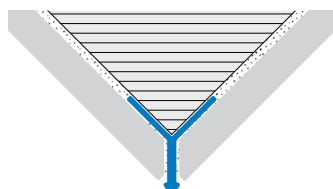
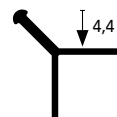

**MOSAICTEC RJF 44 A\* Anodised Aluminium**

A silver (AS) coated aluminium profile which offers adequate protection and tolerance to wear over time.

The surface of this anodised aluminium profile has been chrome-effect (ASB) treated in order to give that sparkling effect in combination with bathroom ware. The shiny gold finish effect (AOB) is also requested for particular combination in interior decorating design.

	H=mm	Art.		
Material: Extruded anodised aluminium	4,4	RJF	44	AS/ASB/AOB
Finish: Silver (AS), Polished chrome (ASB), Bright polished gold (AOB)				
Length: 2,70 metres				
☒ "thin" line				





trialjolly™ TJ

**TRIALJOLLY TJ** is a profile conceived to edge elegantly tiled walls when ceramic tiles do not cover the whole wall height. TRIALJOLLY TJ softens the sharp corners resulting from partially tiled walls.

The 45° corner created by this profile decorates in a precise and functional way the tile edge, which would otherwise be unaesthetic and sharp.

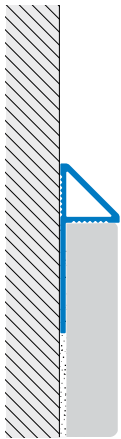
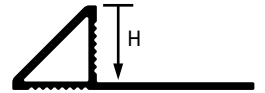

**TRIALJOLLYTJ-A\* Extruded Aluminium**

A silver (AS) coated aluminium profile which offers adequate protection and tolerance to wear over time.

The surface of this anodised aluminium profile has been chrome-effect (ASB) treated in order to give that sparkling effect in combination with bathroom ware.

	H=mm	Art.		
Material:	80	TJ	80	AS/ASB
Extruded anodised aluminium	100	TJ	100	AS/ASB
Finish: Silver (AS), Bright polished chrome (ASB)	125	TJ	125	AS/ASB
Length: 2,70 metres				

**TRIALCAPSULETJC and TJT**

Corner junctions and end-caps for TRIALJOLLY series.

Corner junction	Art.		
Material:	TJC	80	AS/ASB
Extruded anodised aluminium	TJC	100	AS/ASB
Finish: Silver (AS), Bright polished chrome (ASB)	TJC	125	AS/ASB

End cap	Art.		
Material:	TJT	80	AS/ASB
Extruded anodised aluminium	TJT	100	AS/ASB
Finish: Silver (AS), Bright polished chrome (ASB)	TJT	125	AS/ASB



CRM - BT

Aluminium profiles patented to connect floor and wall coverings in glass mosaic and thin tiles. Solves the problem of hygienic cleaning for internal angles typical of work-surfaces and shower area.



Section CRM



Section BT

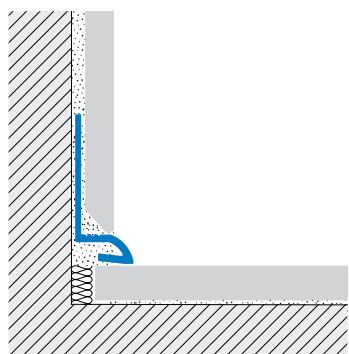

**MOSAICTEC CRM 44 A\* Anodised Aluminium**

A silver coated aluminium (AS) profile which offers adequate protection and tolerance to wear over time.

The surface of this anodised aluminium profile has been chrome or gold-effect treated in order to give that sparkling effect in combination with bathroom ware.

**Skirting BT 45 A\* Anodised Aluminium**

A silver coated aluminium (AS) profile which offers adequate protection and tolerance to wear over time.

The surface of this anodised aluminium profile (ASB) has been chrome-effect treated in order to give that sparkling effect.

	H=mm		Art.	
Material: Extruded anodised aluminium	4,4	CRM	44	AS/ASB/AOB
Finish: Silver (AS), Polished chrome (ASB), Bright polished gold (AOB)				
Length: 2,70 metres				
☒ "thin" line				

Material: Extruded anodised aluminium	4,5	BT	45	AS/ASB
Finish: Silver (AS), Polished chrome (ASB)				
Length: 2,70 metres				
☒ "thin" line				



# mosaictec LIM 51

**MOSAICTEC LIM 51** decorative listello in aluminium for vitreous mosaic with reduced thickness.

This innovative profile perfectly integrates with the grout line, without displacing the mosaic covering pre-existing joints, and thus creating beautiful aesthetic effects, both horizontally and vertically with a high flexibility in the tiling pattern.

The profile particular section allows its installment just with a simple widening of the tesseras, which once returned in their former position keep the profile in the right position, without modifying the joints interax.

A simple solution to customize the mosaic adding a special touch also to the standard, easy to find versions.

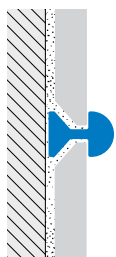
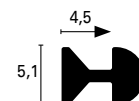

## MOSAICTEC LIM 51 A\* Anodised Aluminium

A silver (AS) coated aluminium profile which offers adequate protection and tolerance to wear over time.

The surface of this anodised aluminium profile has been chrome-effect (ASB) treated in order to give that sparkling effect in combination with bathroom ware shiny gold finish effect is also requested for particular combination in interior decorating design.

	B=mm	Art.		
Material: Extruded anodised aluminium	5,1	LIM	51	AS/ASB/AOB
Finish: Silver (AS), Polished chrome (ASB), Bright polished gold (AOB)				
Length: 2,70 metres				
☒ "thin" line				



mosaic+tec LIM 44

**MOSAITEC LIM** innovative multi-purpose profile for vitreous mosaic with reduced thickness.

- **Decorative listello usable horizontally and vertically, even cut to size.**
- **Junction between mosaic and ceramic tiles.**
- **Torus moulding for classic finishes.**

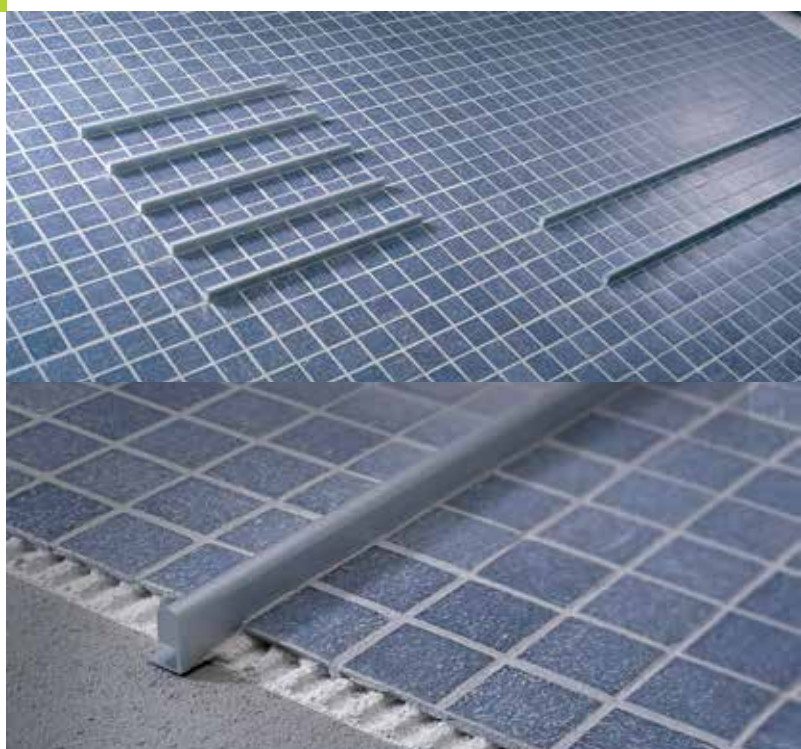

**MOSAICTEC LIM 44 A\* Anodised Aluminium**

A silver coated aluminium profile (AS) which offers adequate protection and tolerance to wear over time.

The surface of this anodised aluminium profile has been chrome-effect (ASB) treated in order to give that sparkling effect in combination with bathroom ware.

The shiny gold finish effect (AOB) is also requested for particular combination in interior decorating design.

	H=mm	Art.		
Material: Extruded anodised aluminium	4,4	LIM	44	AS/ASB/AOB
Finish: Silver (AS), Polished chrome (ASB), Bright polished gold (AOB)				
Length: 2,70 metres				
☒ "thin" line				





# planotec BP

Profile suitable as a technical junction for tiled kitchen tops. The profile shows a moulded part to match with the kitchen top edge and a vertical trim, covering the top thickness. High technical and aesthetic functions.

**Planotec BP** is in silver anodised extruded aluminium. External corner aluminium junctions available.

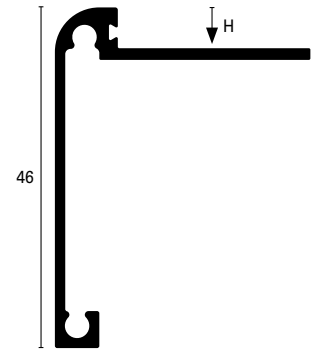

(BP 45\*)

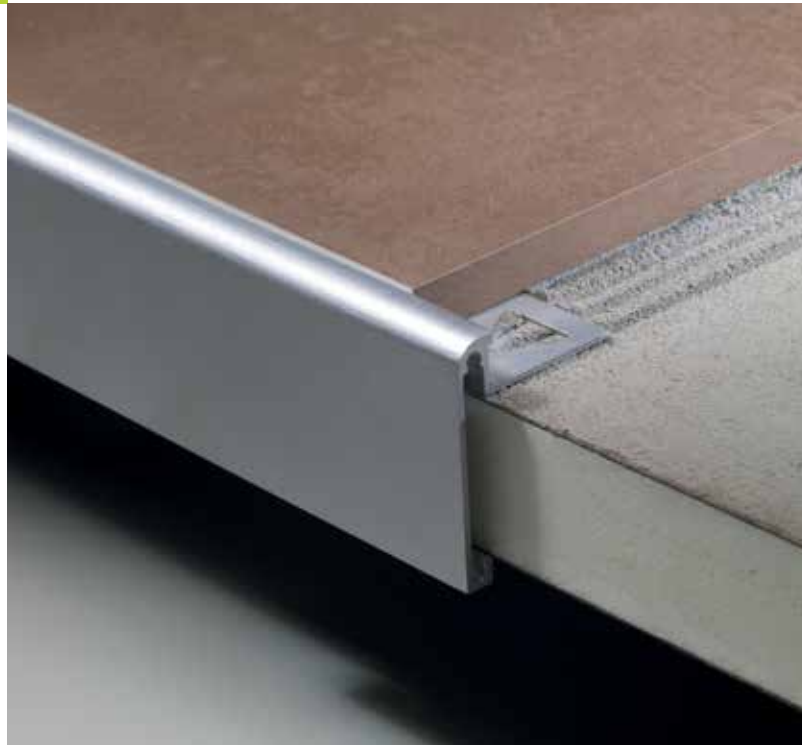
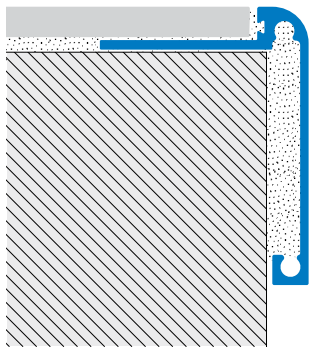

### PLANOTEC BP-AS Anodised Aluminium Silver

A silver coated aluminium profile which offers adequate protection and tolerance to wear over time.

### PLANOTEC BPE-AS Anodised Aluminium Silver

Universal external angle in aluminium adaptable to all heights and which can be used as an end piece.

	H=mm	Art.		
Material:	4,5	BP	45	AS
Extruded anodised aluminium	10	BP	100	AS
Finish: Silver (AS)	12,5	BP	125	AS
Length: 2,70 metres				
"thin" line				

Material:	46	BPE	AS
Extruded anodised aluminium			
Finish: Silver (AS)			



# squarejolly SJQ

**Squarejolly SJQ** is an aluminium decorative strip for ceramic tiles. Its particular squared section ensures high modularity also with the modern rectified tiles formats. Thanks to the profile optimized mechanical anchorage provided by the two "dovetailed cavities" it is also ideal as a "boiserie" finishing solution and can be applied after the tiles have been laid.

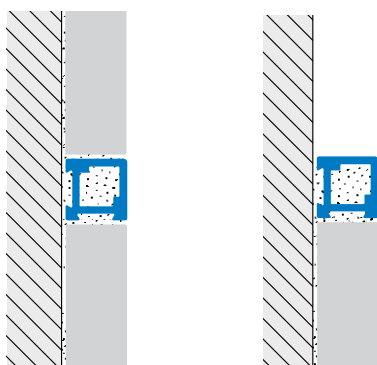
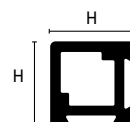

### SQUAREJOLLY SJQ-A\* Anodised Aluminium

A silver coated aluminium profile (AS) which offers adequate protection and tolerance to wear over time.

The surface of this anodised aluminium profile has been chrome-effect (ASB) treated in order to give that sparkling effect in combination with bathroom ware.

### SQUARECAPSULE SJC-A\* Aluminium

Profile inner section has been conceived to match with a special cap which can work as external, internal, three-way junction and end-cap. All these functions with one piece.

	H=mm	Art.		
Material:	8	SJQ	80	AS/ASB
Extruded anodised aluminium	10	SJQ	80	AS/ASB
Finish: Silver (AS), Polished chrome (ASB)				
Length: 2,70 metres				

Material: Aluminium	8	SJC	80	AS/ASB
	10	SJC	100	AS/ASB
Finish: same finish of SJ-A*				



# listtec™ LI 20-LI 22

**LISTEC LI** listello enables the layer to recall the colour combination desired on the tile covering. LISTEC has a shape and a 6 mm thickness which can be readily installed together with the tile grout. It is generally applied horizontally and can adapt to most tile thicknesses in coordination with the ROUNDJOLLY® or KERAJOLLY vertical profile colours.

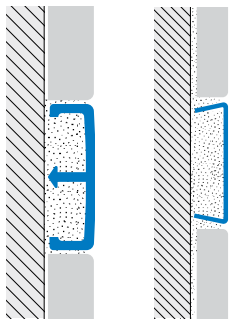
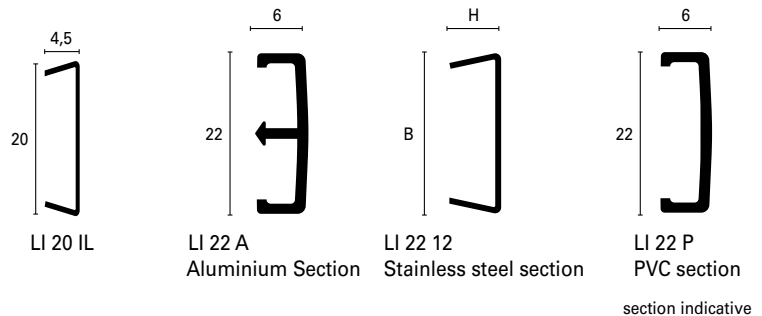

### LISTEC LI 20-22 I\* Stainless steel Polished AISI 304 - DIN 1.4301

Listello in stainless steel where a decorative effect needs to be combined with durability.

Available in polished (IL) or brushed (IS) version.

	BxH	Art.		
Material:	4,5x20	LI	20	IL/IS
Stainless steel AISI 304	7x22	LI	22	IL/IS
Finish: Polished (IL), Brushed(IS)				
Length: 2,70 metres				

### LISTEC LI 22 A\* Anodised Aluminium

Listello in silver anodised aluminium (AS) in a modern matt finish. It allows the creation of cost-effective decoration while matching with the tile finish.

The surface has been bright polished Chrome (ASB) or Gold (AOB) in order to give that sparkling effect in combination with bathroom ware.

Material:	6x22	LI	22	AS/ASB/AOB
Extruded anodised aluminium				
Finish: Silver (AS), Polished chrome (ASB), Bright polished gold (AOB)				
Length: 2,70 metres				

### LISTEC LI 22 P51 Full body coloured Synthetic Resin

The product is entirely of a solid colour compound and not colour coated. The profile can be utilized in the most diverse environments. This product maintains a good performance over time against UV rays and small scratches are not so visible, tolerates mechanical impacts and diluted chemicals.

Material: Resintop	6x22	LI	22	P51
Colour: Black				
Length: 2,70 metres				



**LISTEC LI 10** decorative strips in aluminium for ceramic tiling. The particular squared cross section integrates perfectly with the new ground sizes in porcelain stoneware and the fixed depth of 8 mm makes it versatile and adaptable to any tile thickness over 7 mm thanks also to the special compensating shims ( see page 126).

# listec LI 10

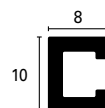

### LISTEC LI 10:

1. Enhances the bath finish by decorating the tiles with a modern, minimalist design.
2. Eliminates the need for special pieces, adapting to every type of finish and size of tile.
3. The shim LIA makes it suitable for tiles from 10 to 12 mm.

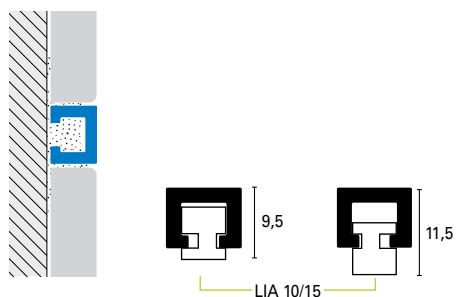

### LISTEC LI 10-A\* Anodised Aluminium

Aluminium Listello available in Silver anodised (AS), Bright polished chrome (ASB) or Silver Brushed (ASS), to create decorative effects with minimal and elegant solutions.

	B=mm	Art.		
Material: Anodised Aluminium	10	LI	10	AS/ASB/ASS
Finish: Silver (AS), Polished chrome (ASB), Silver brushed (ASS)				





**LISTEC LI 15** decorative strips in aluminum for ceramic tiling. The particular squared cross section integrates perfectly with the new ground sizes in porcelain stoneware and the fixed depth of 8 mm makes it versatile and adaptable to any tile thickness over 7 mm (see pag. 126). The corner is finished with the joint series Squarejolly, Roundjolly or Kerajolly to ensure perfect finish and prevent unsightly 45° cuts.

# listtec™ LI 15

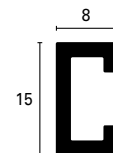

### LISTEC LI 15:

1. Enhances the bath finish by decorating the tiles with a modern, minimalist design.
2. Eliminates the need for special pieces, adapting to every type of finish and size of tile.
3. Speeds and improves installation for a workmanlike job finished elegantly.
4. Many innovative finishes of the visible surface.
5. The shim LIA makes it suitable for tiles from 10 to 12 mm.

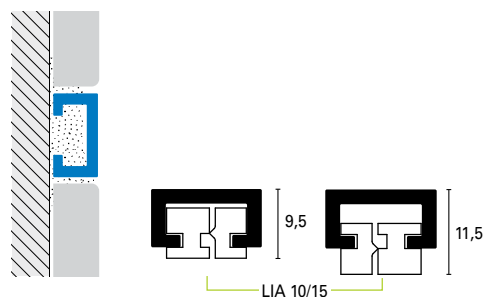

### LISTEC LI 15 A\* Anodised Aluminium

The surface in anodised aluminium silver(AS), copper(AR) or titanium (AT) with a mat modern and trendy finish. It allows creating decorative effects in an economic way, while matching different tiled coverings. Silver brushed version (ASS) for a more design and sophisticated option.

### LISTEC LI 15 A\*B Bright polished Aluminium

Its surface has been anodised and bright polished. It offers an adequate protection and tolerance to wear over time with an innovative aesthetic effect. Available: Polished chrome (ASB), bright polished Gold (AOB), bright polished Copper (ARB), bright polished Titanium (ATB), Silver grinded bright polished (ASGB), Silver sanded bright polished (ASXB), Champagne sanded bright polished (ACXB), Silver brushed bright polished (ASSB).

### LISTEC LI 15 AT\* Aluminium wooden effect

Decorative listello in aluminium texture wooden effect to match with wooden furnishing and floors. Version Whitened oak (ATRS), Wengé (ATWE), Teak (ATTK), Oak (ATTRO).

	H=mm		Art.	
Material: Extruded anodised aluminium Finish: Silver (AS), Copper (AR), Titanium (AT), Silver brushed (ASS), Polished chrome (ASB), Bright polished Gold (AOB), Copper bright polished (ARB), Bright polished titanium (ATB), Silver grinded bright polished (ASGB), Silver sanded bright polished (ASXB), Champagne sanded bright polished (ACXB), Silver brushed bright polished (ASSB), Oak whitened (ATRS), Wengé (ATWE), Teak (ATTK), Oak (ATTRO)	15	LI	15	AS/AR/ AT/ASS/ ASB/AOB/ ARB/ATB/ ASGB/ASXB/ ACXB/ASSB/ ATRS/ATWE/ ATTK/ATRO
Length: 2,70 metres				



**LISTEC LI 10** glittery aluminium decorative listello for tiled walls. Its square section matches with porcelain stoneware rectified edges and its 8 mm width makes it versatile and suitable for all tiles thickness over 7 mm, thanks also to its shims (see pag.126). The glittered surface is covered by a special protective resin layer, against scratches and bumps.

# listtec™ LI 10 glitter

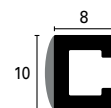

### LISTEC LI 10 glitter:

1. Enhances the bath finish by decorating the tiles with a modern, minimalist design.
2. Eliminates the need for special pieces, adapting to every type of finish and size of tile.
3. The shim LIA makes it suitable for tiles from 10 to 12 mm.

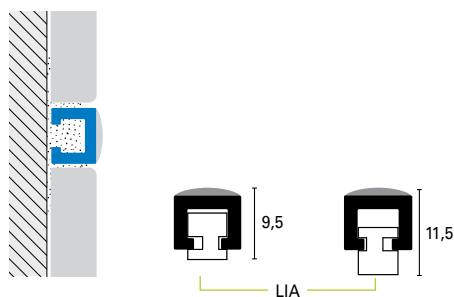

### LISTEC LI 10-A\* Anodised Aluminium glitter

Decorative listello in Anodised Aluminium Silver (AGS), Carbon (AGC) and Gold (AGO), it enables you creating unique and elegant decorative effects.

	B=mm	Art.		
Material: Anodised Aluminium	10	LI	10	AGS/AGC/AGO
Finish: Glitter Silver (AGS), Glitter carbon (AGC), Glitter Gold (AGO)				



**LISTEC LI 10** glittery aluminium decorative listello for tiled walls. Its square section matches with porcelain stoneware rectified edges and its 8 mm width makes it versatile and suitable for all tiles thickness over 7 mm, thanks also to its shims (see pag.126). The glittered surface is covered by a special protective resin layer, against scratches and bumps.

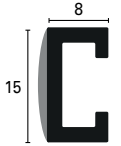

## listtec™ LI 15 glitter

### LISTEC LI 15 glitter:

1. Enhances the bath finish by decorating the tiles with a modern, minimalist design.
2. Eliminates the need for special pieces, adapting to every type of finish and size of tile.
3. The shim LIA makes it suitable for tiles from 10 to 12 mm.

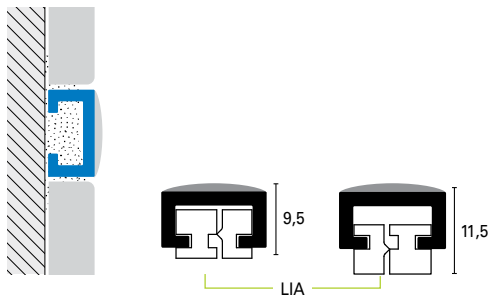

### LISTEC LI 15-A\* Anodised Aluminium glitter

Listello in Anodised Aluminium glitter available in Soft Silver (AGSS), Soft Bronze (AGSB) and Soft Anthracite (AGSM). It enables you creating unique and elegant decorative effects.

	B=mm	Art.		
Material: Anodised Aluminium	15	LI	15	AGSS/AGSB/ AGSM
Finish: Glitter soft Silver (AGSS), Glitter soft bronze (AGSB), Glitter soft anthracite (AGSM)				



# listellos LIA

The compensating shims for listellos are patented accessories in plastic material which can be installed on all the aluminium listellos by Profilitec SpA ( both the standard and the Glittered ones). The shims are suitable both for the 15 mm and for the 10 mm version (it needs to be cut and the suitable one is used).

The shim enables a double use as it can be placed in the lower part of the profile thus matching 8 to 9,5 mm thickness or upside down to match 8 to 11,5 mm thickness.

In this way you can adapt the 8 mm thick listellos also with 10 or 12 mm tiles, thus avoiding the difficult and not always well done compensation with the tiling glue.

Just with a single accessory you will then get a perfect listello for tiles of 8, 10 and 12 mm.

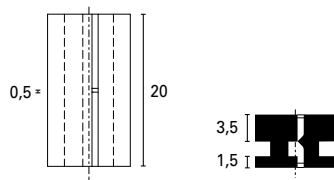

### INSTALLATION SCHEMES:

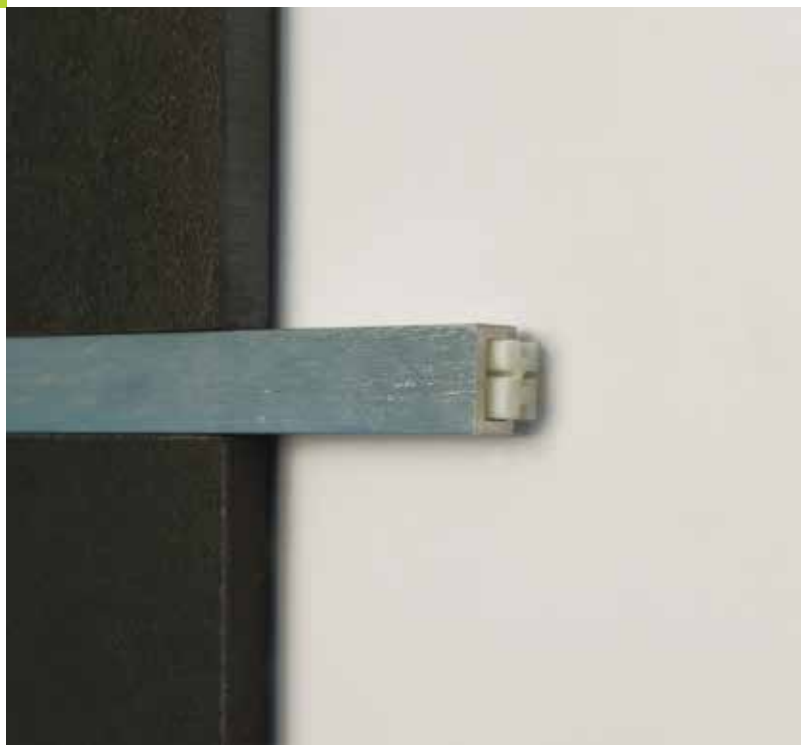
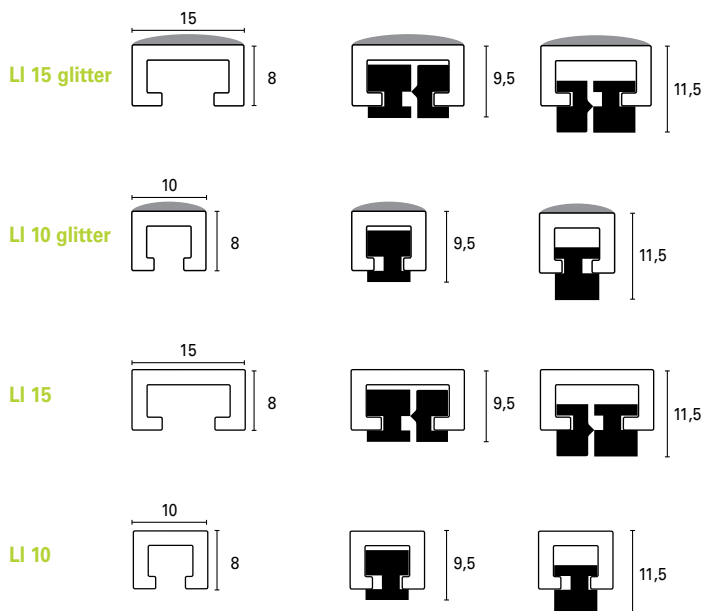

### SHIM FOR LISTELLOS-LIA10/15

The compensating shim is made from a single piece which need to be cut to be used. It matches both our 15 mm wide listello and that 10 mm wide.

Once cut, you will have to decide whether to put it on one side- to compensate 8 to 9,5 mm ( for 10 mmm tiles) or on the other side, that compensating 8 to 11,5 mm ( suitable for 12 mm tiles).

We suggest to use 1 shim every 50 cm to keep the proper alignment along the whole listello length.

	L	Art.		
Material: Polypropylene	20	LIA	10/15	
Finish: Natural				





# appendo APP 15

**APPENDO** is an innovating decorative vertical listello- patented- which can be used also as hanger, thanks to its particular shape  
To be installed on tiled bathrooms, where it provides a decorative and functional solution.

The listello has to be fixed on the wall with the special fixing plates. The provided compensating washers can make the profile suitable not only for tiles of 8 but also of 10 and 12,5 mm.

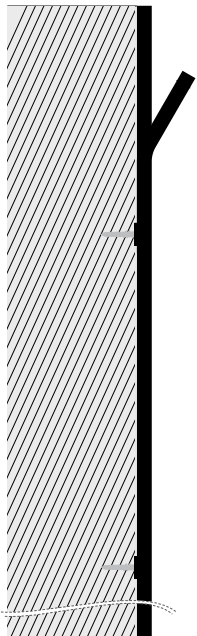

Fixing brackets from the top  
(100 - 835 - 830 - 835 - 100) (mm)



## APPENDO – APP 15 A\* Extruded Aluminium

APPENDO is an innovative vertical decorative listello which can be used in situations where you need at the same time a design solution and the use of a hook or a hanger.

Appendo can be used with one or more profiles alongside.

The profile is available in bars of 2.70 meters that need to be cut to place the protruding part to the desired height. You will then use the remaining piece in the upper part to complete the pattern.

The profile is supplied with fixing metal plates that must be fastened to the wall before installation of the tiles, with special dowels. Suitable for tiles from 8 mm to 10/12,5 mm with the provided special compensating washers. The profile is available in Bright polished chrome (ASB) or Bright Polished Silver Sanded (ASXB), Bright Polished Champagne Sanded (ACXB).

	BxH	Art.		
Material: Extruded Aluminium	15x8	APP	15	ASB/ASXB/ACXB
Finish: Polished chrome (ASB), Silver bright polished sanded (ASXB), Champagne bright polished sanded (ACXB)				
Length: 2,70 metres				



**ROUNDCORNER RO** series comprises several corner protectors with rounded edge in order to best protect in compliance with the accident and injury prevention norms. In fact this profile is greatly used in commercial and industrial areas where intense transit occurs.

ROUNDCORNER can perfectly cover over chipped tiled corners and are supplied with self-adhesive glue strips with excellent hold which help absorb shock impact.

# roundcorner™ RO

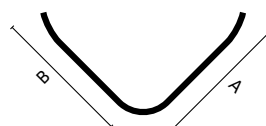

Stainless steel and Brass Section

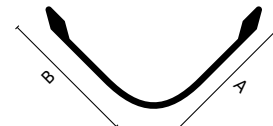

Aluminium Section

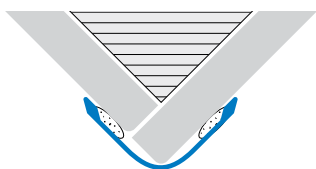

### ROUNDCORNER RO 25 A11A Self-Adhesive Powder Coated Aluminium

Profile varnished with a polyester powder coating. ROUNDCORNER is ready to be fixed onto the corners of the wall. It covers a width of 25 mm which thanks also to its rounded section satisfies both technical and safety requirements and domestic decor needs.

	AxB		Art.	
Material: Powder coated aluminium	25x25	RO	25	A11A
Finish: Pure white				
Length: 2,70 metres				

### ROUNDCORNER RO 25 A\*A Self-Adhesive Anodised Aluminium

The self-adhesive aluminium ROUNDCORNER rounded profile is ready to be fixed onto the corners of the wall. It covers a width of 25 mm. which satisfies both technical and safety requirements as well as for aesthetics in domestic areas.

Material: Extruded anodised aluminium	25x25	RO	25	ASA/AOA/ ABA
Finish: Silver (ASA), Gold (AOA), Bronze (ABA)				
Length: 2,70 metres				

### ROUNDCORNER RO-ILA Stainless steel Polished self-adhesive

Corner protection stainless steel polished rounded profile is supplied in different sizes so it can meet several technical and safety requirements and norms present in hospitals, public and food processing plants.

Thickness RO 25: 1 mm

Thickness RO 30 / 40 / 50: 1,2 mm

Material: Stainless steel	25x25 30x30 40X40 50X50	RO RO RO RO	25 30 40 50	ILA ILA ILA ILA
Finish: Polished (ILA)				
Length: 2,70 metres				
Width: 25-50 mm				
Surface with protection film strip				

### ROUNDCORNER RO-OLA Brass Polished self-adhesive

Corner protection brass profile with rounded corner and self-adhesive for a further decorative choice along with the suitability of safety regulations in public constructions and other required areas

Thickness RO 25: 1 mm

Thickness RO 30 / 40 / 50: 1,2 mm

Material: Laminated brass	25x25 30x30 40X40 50X50	RO RO RO RO	25 30 40 50	OLA OLA OLA OLA
Finish: Polished (OLA)				
Length: 2,70 metres				
Width: 25-50 mm				
Surface with protection film strip				



keracorner™ CO

**KERACORNER** series comprises a complete series of corner profiles for the protection most exposed parts of the walls, with all kinds of covering. Mainly used in commercial and industrial areas where intense transit occurs, these profiles are available in different sizes, materials and finishes to meet all possible technical needs.

KERACORNER perfectly covers over chipped tiled corners and are supplied with self-adhesive glue strips with excellent hold which helps absorb shock impact.

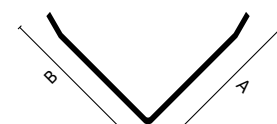

Stainless steel and Brass Section



Aluminium Section



**KERACORNER CO 25 A11A Self-Adhesive Powder Coated Aluminium**

This corner profile is entirely varnished with a polyester powder coating. Being self-adhesive, it is ready to be fixed onto the corners of the wall. It covers a width of 25 mm and perfectly satisfies both technical and decor needs. Suitable for all kinds of environments included the domestic one

	AxB		Art.	
Material: Powder coated aluminium	25x25	CO	25	A11A
Finish: Pure white				
Length: 2,70 metres				

**KERACORNER CO 25 A\*A Self-Adhesive Anodised Aluminium**

Self-adhesive anodised aluminium profile, ready to be easily fixed onto the wall's corners. It covers a width of 25 mm. and well satisfies both technical and aesthetics requirements. Suitable for all kinds of environments included the domestic one.

Material: Extruded anodised aluminium	25x25	CO	25	ASA/AOA/ ABA
Finish: Silver (ASA), Gold (AOA), Bronze(ABA)				
Length: 2,70 metres				

**KERACORNER CO-ILA Self-Adhesive Polished Stainless steel**

Corner protection stainless steel profile which guarantees high performances of corner protection and hygiene. Especially conceived for public and food processing plants etc.

These profiles can also be made in stainless steel grade AISI 304 or AISI 316.CO 30 is available in the polished version (IL) or brushed (IS).

Thickness CO 25: 1 mm

Thickness CO 30 / 40 / 50: 1,2 mm

Material: Stainless steel	25x25 30x30	CO CO	25 30	ILA ILA
Finish: Polished (ILA), Brushed (ISA)	40X40 50X50	CO CO	40 50	ILA ILA
Length: 2,70 metres	30x30	CO	30	ISA
Width: 25-50 mm				
Surface with protection film strip				

**KERACORNER CO-OLA Self-Adhesive Polished Brass**

Corner protection brass profile with self-adhesive for a further decorative choice along with guarantee of corner protection against mechanical impacts.

Thickness CO 25: 1 mm

Thickness CO 30 / 40 / 50: 1,2 mm

Material: Laminated brass	25x25 30x30	CO CO	25 30	OLA OLA
Finish: Polished (OLA)	40X40 50X50	CO CO	40 50	OLA OLA
Length: 2,70 metres				
Width: 25-50 mm				
Surface with protection film strip				



**SANITEC SB-IL** is a stainless steel internal cove profile designed to ensure hygienic functions in all areas subject to sanitary inspection. Thanks to its internal curvature and to the characteristics of the used material, it perfectly meets the hygiene requirements and applications expected in hospitals, public and food processing plants, public toilets and other required areas. This profile is to be installed during laying, providing a neat finish at the same level with the adjacent tiled surfaces.

# sanitec™ SB-IL

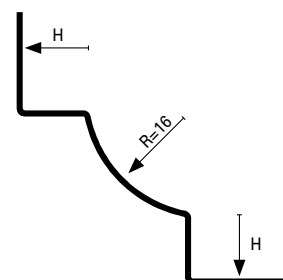

(SB 80\*)

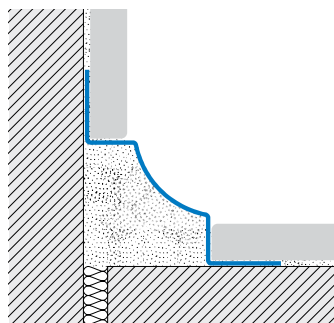

### SANITEC SB-IL Polished Stainless steel AISI 304 - DIN 1.4301 Lucido

Internal cove profile to be installed while tiling between two tiled walls. Stainless steel AISI 304 standard ensures high resistance against corrosion, being then ideal for food processing plants, sanitary, chemical and hospital sectors. Very good mechanical resistance.

Possibility of customizing the profile height for the wall or the floor from 8 to 12,5 mm. Junction pieces available: internal (SBI\*), external (SBE\*) and three-way (SBT\*) to finish the corners in a neat and elegant way.

Combining one SJ profile with the corner pieces it is possible to get a three-way finish by using in vertical a more minimalist and aesthetically effective solution.

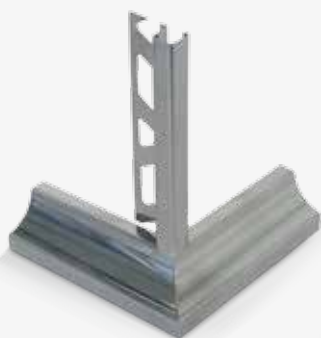

	H=mm	Art.		
Material:	8	SB	80	IL
Stainless steel AISI 304	10	SB	100	IL
Finish: Polished (IL)	12,5	SB	125	IL
Length: 2,70 metres				
Surface with protection film strip				

Material:		SBI		ILSET 2
Stainless steel AISI 304		SBE		ILSET 2
Finish: Polished (IL)		SBT		ILSET 2
Junction:				
internal ( SBI *)				
External (SBE *)				
end- cap (SBT *)				





**SANITEC RS-IL** stainless steel internal cove profile is designed to ensure hygienic functions in all areas subject to sanitary inspection. Thanks to its internal curvature and to the characteristics of the used material, it perfectly meets the hygiene requirements and applications expected in hospitals, public and food processing plants, public toilets and other required areas. This profile is to be installed during laying, providing a neat finish at the same level with the adjacent tiled surfaces.

# sanitec™ RS-IL

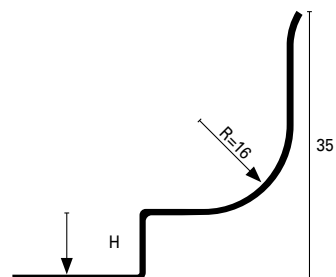

(RS 80\*)

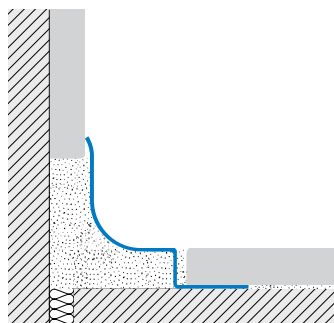

**SANITEC RS-IL Stainless steel AISI 304 - DIN 1.4301 Lucido**

Internal cove profile conceived to cover an existing tiled surface, to be installed while flooring. Stainless steel AISI 304 standard ensures high resistance against corrosion, being then ideal for food processing plants, sanitary, chemical and hospital sectors. Very good mechanical resistance.

Internal corner / external available (RSI / RSE) And with the perforated flange installed at floor level (RSIR / RSER).

	H=mm		Art.	
Material:	8	RS	80	IL
Stainless steel AISI 304	10	RS	100	IL
Finish: Polished (IL)	12,5	RS	125	IL
Length: 2,70 metres				
Surface with protection film strip				

Material:	RSI	ILSET 2
Stainless steel AISI 304	RSE	ILSET 2
Finish: Polished (IL)	RSIR	ILSET 2
	RSER	ILSET 2
Perforated flange (*R)		
junction:		
internal (RSI*)		
External (RSE*) and with perforated flange (*R)		



**ROUNDCORNER** is a rounded corner stainless steel profile especially designed for the protection of ceramic wall coverings. To be installed while tiling, it provides a precise and neat finish at the same level with the tiled covering. **ROUNDCORNER** meets public buildings technical and safety requirements and norms mandatory in hospitals, public and food processing plants and other required areas.

roundcorner™ *RE*

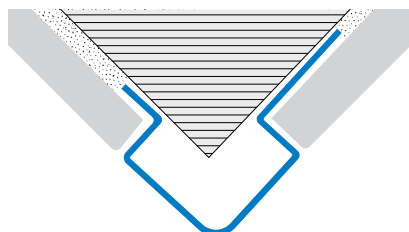
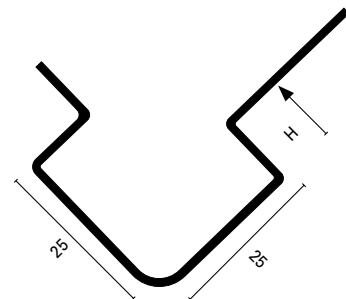

**ROUNDCORNER RE-IL Polished Stainless steel AISI 304 - DIN 1.4301**

Stainless steel AISI 304 standard ensures high resistance against corrosion, being then ideal for hygienic purposes. It is requested for food processing plants, butchers, public toilets, commercial kitchens, hospitals. Very good mechanical resistance.

	H=mm	Art.		
Material:	8	RE	80	IL
Stainless steel AISI 304	10	RE	100	IL
Finish: Polished (IL)	12,5	RE	125	IL
Length: 2,70 metres				
Surface with protection film strip				



**SANITEC SB15-IL** stainless steel internal cove profile is designed to ensure hygienic functions in all areas subject to sanitary inspection. Thanks to its internal curvature and to the characteristics of the used material, it perfectly meets the hygiene requirements and applications expected in hospitals, public and food processing plants, public toilets and other required areas. This profile is to be installed during laying, providing a neat finish at the same level with the adjacent tiled surfaces.

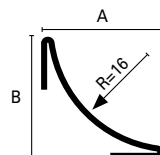

# sanitec™ SB15-IL

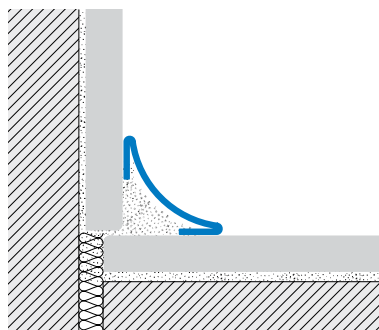

**SANITEC SB15-IL Stainless steel AISI 304 - DIN 1.4301 Lucido**  
Internal cove profile to be installed while tiling between two tiled surfaces. Stainless steel AISI 304 standard ensures high resistance against corrosion, being then ideal for food processing plants, sanitary, chemical and hospital sectors. Very good mechanical resistance.

	AxB	Art.		
Material: Stainless steel AISI 304	15x15	SB	15	IL
Finish: Polished (IL)				
Length: 2,70 metres				
Surface with protection film strip				

Note: end-caps not available



# coflex™ CR

The modular combination system called "Clip System" allows one to match all possible tile thickness still with the same base module, thus resulting in both a time saver and actual material saved. The KJ – Kerajolly profile functions as the perforated side flanges for the laying so to adapt to the different heights of the tiles for wall and floor coverings (e.g. floor height 12,5 mm. - wall covering height 8 mm.). KERAJOLLY small off-cuts can also be utilized for this purpose.

E.g. of COFLEX assembly for installation: if the thickness of a tile is of 10 mm, utilize the KERAJOLLY KJ 8 mm. height profile (page 111) as the combination with the CR base module raises the height by 2 mm. matching it then to the 10 mm. tile thickness.

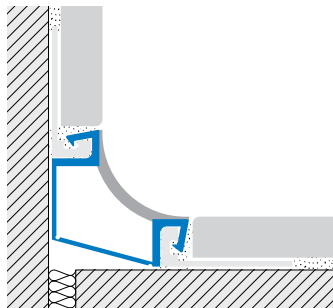

**COFLEX CR** patented series is expressly conceived to perimeter joint wall/ floor coverings supplying sufficient elasticity for the expansion and meeting the cove base hygienic corner cleanliness requirements. It also serves as a sound breaker of the covered surfaces so that trampling of foot steps is not transmitted to the adjacent walls.

**COFLEX CR** consists of a main curved co-extruded hard/soft combination module between CR 16 and KJ inserts which slide into CR 16 tracks allowing it to adapt to any covering height and providing a perfect anchoring to the tiled covering.

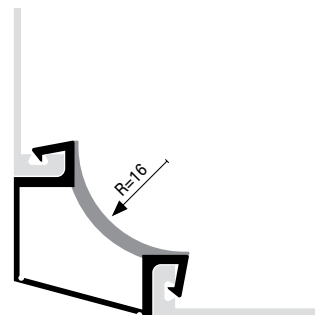

### COFLEX CR 16 P\* Synthetic resin co-extruded

Main frame co-extruded profile with soft internal cove supplied in different colours. The profile flange inserts are supplied separately as the specific required height needs to be provided.

### COFLEX CR Jointing and derivation pieces

End caps, internal jointing corner pieces, external and tri-axis jointing pieces. These special pieces help the layer finish off the perimeter laying for two way and three way connections in a most precise and appropriate manner.

	Colour	Art.		
Material:	11= Pure white	CR	16	P11
Resinflex + Resinil	23= Cement grey	CR	16	P23
Radius: 16mm	32= Dark beige	CR	16	P32
Length: 2,70 metres				

	Description	Art.	
Material: Polypropylene	Internal corner	CRI	+ Colour
	External corner	CRE	+ Colour
	Three way junction	CRT	+ Colour
	Endcap	CRF	+ Colour







**SANITEC ER** stainless steel internal cove profile is designed to ensure hygienic functions in all areas subject to sanitary inspection. Thanks to its internal curvature and to the characteristics of the used material, it perfectly meets the hygiene requirements and applications expected in hospitals, public and food processing plants, public toilets and other required areas. This profile is to be installed during laying, providing a neat finish at the same level with the adjacent tiled surfaces.

sanitec™ ER

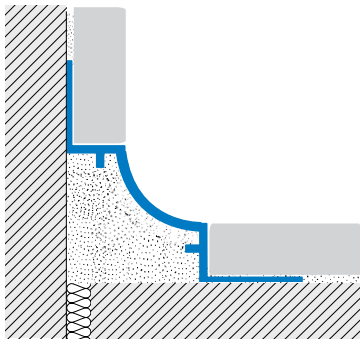
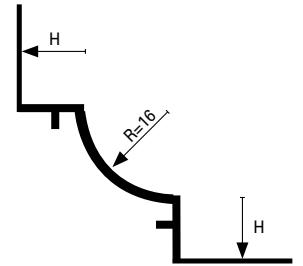

**SANITEC ER Full body coloured Synthetic Resin Resinil**

Internal cove profile to be installed whilst tiling between two tiled surfaces. The material used with the addition of stabilizers resists to the common diluted chemical agents and to little scratches.

	H=mm	Art.		
Material: Resin	9 11	ER ER	9 11	P11/P22 P11/P22
Finish: P11 (White), P22 (grey)				
Length: 2,70 metres				
Surface with protection film strip				

	Description	Art.	
	Internal corner	ERI	P11/P22 SET
	External corner	ERE	P11/P22 SET
	Three way junction	ERT	P11/P22 SET
	Endcap	ERF	P11/P22 SET



sanitec™ IC

**SANITEC IC** is a production series conceived to create the hygienic joint cove between wall and floor or between two walls vertically, in particular in hospitals, chemical and food industry environments. The product is supplied ready to be fixed onto existing coverings so it is suitable for restructuring jobs and complies with the current sanitary and safety norms and regulations. The round moulded body of this profile ensures an excellent contour hold. The H 60 model serves also as wall skirting. Suggested application with our special adhesive.

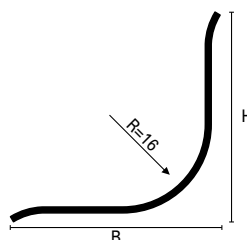

Stainless steel section

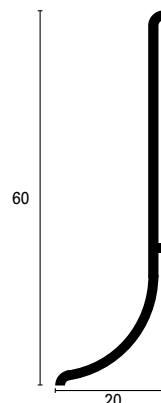

PVC section

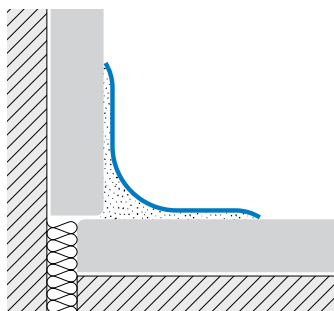

**SANITEC IC-ILN Polished Stainless steel AISI 304 - DIN 1.4301**

The stainless steel quality of this cove base profile ensures a long lasting resistance to most of diluted chemical agents, hence it is considered ideal for food processing, hospitals and laboratory environments. Great tolerance to mechanical stress.

IC 25: Junction pieces available. Internal ICI, external ICE, three-way code ICT.

**SANITEC IC 60 P 11 Synthetic Resin**

Full body pure white resin UV stabilized wide cove base profile. It is utilized in diverse environments because it is resistant to most conventional diluted chemical agents and to minor scratches.

	BxH	Art.		
Material: Stainless steel AISI 304	25x25	IC	25	IL
Finish: Polished (IL)				
Length: 2,70 metres				
Surface with protection film strip				

Material: Resintop	20x60	IC	60	P11
Colour: Pure white				
Length: 2,70 metres				



**INTERJOLLY** optimizes the corner joining of the tile covering between floor and wall, while leaving the necessary space for the expansion with adjacent walls. This profile has a perforated flange which is applied under the tile. It can also serve as a cove base for shower tray and bathtub perimeter so to avoid the silicon lining which inevitably turns a yellow unaesthetic discoloured tone in time. The moulded cove base made with the application of the profile makes every internal corner and crevice extremely easy to clean and therefore more hygienic.

interjolly™ IJ

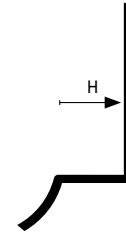

Stainless steel section

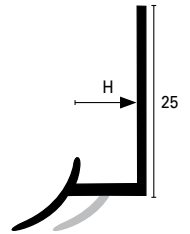

PVC section

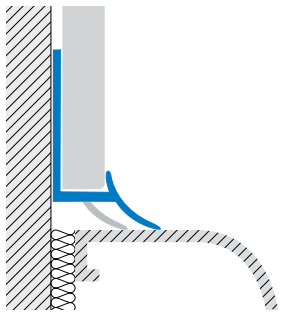

**INTERJOLLY IJ-P\* Full body coloured Synthetic Resin**

The product is entirely of a solid colour compound and not colour coated. This can be utilized in the most diverse environments which require coverings. Moreover, is easy to cut to size so the laying may result quicker and less time consuming therefore one would economize in terms of labor over the entire project budget.

This product maintains a good performance over time against UV rays and small scratches are not so visible, tolerates impact and diluted chemicals present in most detergents.

**INTERJOLLY IJ-IL Stainless steel Polished AISI 304 - DIN 1.4301**

Stainless steel profile, AISI 304 standard, ensures high tolerance to corrosion suitable for laboratories, food processing plants, commercial kitchens, slaughter houses, breweries as well as bathrooms for private and public areas.

	Colour	H=7,5mm		
Material: Resintop	11= Pure white	IJ	75	P11
	12= White	IJ	75	P12
Length: 2,70 metres	22= Grey	IJ	75	P22
	31= Bahama beige	IJ	75	P31

	Colour	H=9,5mm		
Material: Resintop	11= Pure white	IJ	95	P11
	12= White	IJ	95	P12
Length: 2,70 metres	22= Grey	IJ	95	P22
	31= Bahama beige	IJ	95	P31

	H=mm	Art.		
Material: Stainless steel AISI 304	8	IJ	80	IL
	10	IJ	100	IL
Finish: Polished (IL)				
Length: 2,70 metres				



Hygienic corner cove profile between wall and wall or wall and floor. Also apt to join profile bathtub rim and shower tray to wall or kitchen counter tops and wall. Normally the gaps are filled in by mould resistant silicone products but still may turn yellow from discoloration and dirt which can stick to the soft silicone. By installing our profiles the gaps and corners are finally clean, neat but most important of all more hygienic. Supplied with self-adhesive strips or applied with silicone.

sanitec™ SB

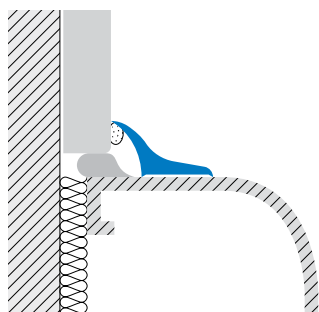

**SANITEC SB 20 A\* Aluminium Powder coated /Silver Anodised**

This profile is a polyester powder varnished or in anodised aluminium finish. It is tolerant to oxidation and to most conventional detergents. Furthermore, its UV resistance makes it adaptable to all sorts of environments. Available also without adhesive (A\*N).

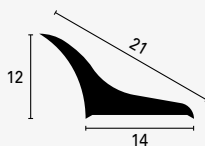

	AxB	Art.		Ades.	Non Ades.
Material: Powder coated aluminium / Extruded anodised aluminium	12x14 12x14	SB	20	A11A ASA	A11N ASN
Finish: Pure white / Silver					
Length: 2,70 metres					

**SANITEC SB 24 P 11 Synthetic Resin**

Full coloured whole synthetic resin profile to apply on several coverings. It is particularly adaptable to plastic tubs because the softer external PVC transparent lips allow it better wedge into the gap.

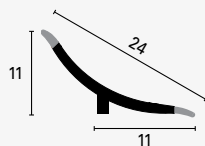

	AxB	Art.		
Material: Resintop	11x11	SB	24	P11
Colori: Pure White with transparent lips				
Length: 2,70 metres				

**SANITEC SB 30 P\* Synthetic Resin**

Full coloured whole synthetic resin profile to apply on several coverings. Its stabilizing properties make the product tolerant to most chemical agents and resistant to slight abrasions.

Junction pieces available in polypropylene. Internal SBI 30 P\*, external SBE 30 P\*, junction SBG 30 P\*, end-cap SBF 30 P.

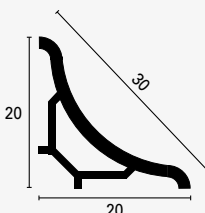

Material: Resintop	20x20 20x20 20x20	SB SB SB	30 30 30	P11 P22 P30
Colours: Pure white Light grey / Beige				
Length: 2,70 metres				





Modern bathtubs and shower trays are made of a special thermoformable material called methacrylate. Creating a profile in the same material ensures perfect integration of the finish of the border between the tub and the profile.

The inside and terminal joints are available in the kit that serves to install a tub against the wall with masonry even on three sides.

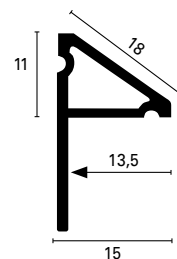

sanitec™ SB

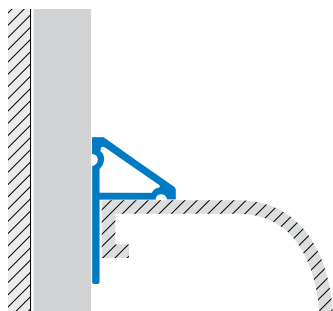

**SANITEC SB Methacrylate**

Cove profile in white methacrylate compound.

1 Kit include: 2 profiles 1,95 metres long + 2 internal corners + 1 right end cap + 1 left end-cap

	AxB	Art.		
Material: Methacrylate	13x11	SB	18	P11
Supplied in Kit				

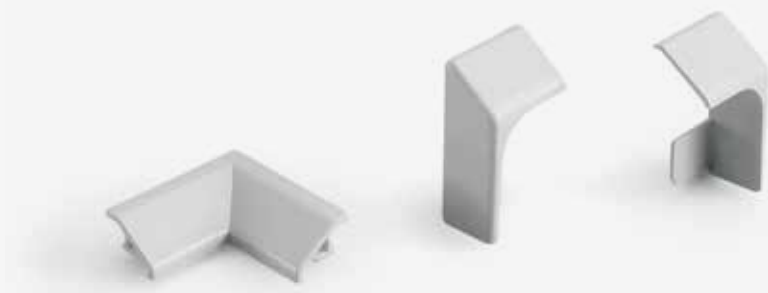



**SANITEC SB 12** Hygienic corner cove profile between wall and wall or wall and floor.

Also apt to join profile bathtub rim and shower tray to wall or kitchen counter tops and wall. Normally the gaps are filled in by mould resistant silicone products but still may turn yellow from discoloration and dirt which can stick to the soft silicone.

By installing our profiles the gaps and corners are finally clean, neat but most important of all more hygienic.

sanitec™ SB

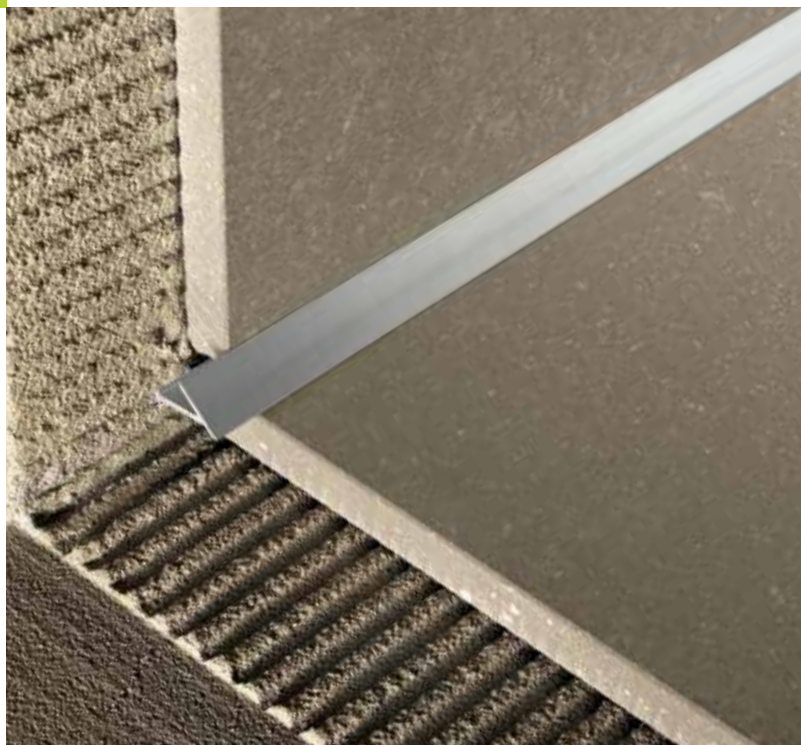
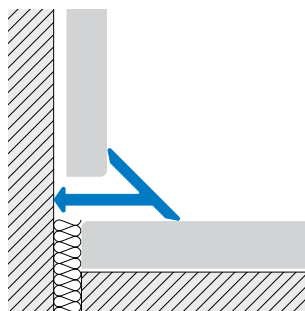
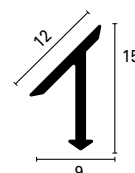

**SANITEC SB 12 A Anodised Aluminium**

A silver coated aluminium (AS) profile which offers an adequate corner edge protection. Granting protection against the aluminium corrosive agents.

The surface of this anodised aluminium profile has been chrome-effect treated in order to give that sparkling effect (ASB) in combination with bathroom ware.

	AxB	Art.		
Material:	12x15	SB	12	AS
Extruded anodised aluminium	12x15	SB	12	ASB
Finish: Silver (AS), Polished chrome (ASB)				
Length: 2,70 metres				













## Profiles and expansion joints

Settlement, deflection, expansion, creeps, shrinkage, thermal and moisture excursions, all these factors contribute to movements and solicitations on the building's structure frame. It is then advisable that a proper expansion and structure joints layout planning is implemented both during the slab/mortar bedding phase and at floor level.

Planning for the right type of joint is a task which involves the calculations of the movement solicitations, tensile strengths and the thermo-hygrometric coefficient readings, in relation to the type of construction and relative coverings and to how they interact with all the combined building materials. The underlying mortar bed sectioning is a determining factor in guaranteeing a job well done, whether the covering is laid with the thin bed adhesive or the traditional deep bed method.

An expansion joint must be placed whenever:

- in correspondence to an underlying substrate material change or alteration and/or slab casting discontinued placements.
- in correspondence to pre-existing discontinuities in substrate such as structural construction joints, screed section edges.
- in correspondence to fixed elements like columns and doors, entrances.
- where there is a change of direction in tiling patterns.
- where tiled floors abut walls or restraining features.

The resulting bays should be as regular as possible. The proportion between the two bay sides should generally not exceed 2:1.

Article	Use	Page
Coflex	CE	separation thin-bed 144
Coflex	CA	separation thin-bed 145
Coflex	CAJ	movement joint invisible 146
Coflex	CTL	mov. joint suitab. for grinding 147
Coflex	CB	interchangeable 148
Coflex	CBL	interchangeable 149
Coflex	CK	technical metal 150
Coflex	CKM	metal for screed 151
Coflex	CMB	modular for screed 152
Coflex	CM	modular deep bed 153
Coflex	CF	separation deep bed 154
Coflex	CD	modular deep bed 155
Coflex	CTM	sep. suitable for grinding 156
Coflex	CR	corner joint 157
Jointec	GE	structural 158
Jointec	GR	structural 159
Jointec	GRM	structural high performance 160
Jointec	GM	structural modular 161
Jointec	GAL	structural floor 162
Jointec	GA	structural floor 163
Jointec	GALP	structural floor-wall 164
Jointec	GAP	structural floor-wall 165
Jointec	GH	structural carriageable 166
Jointec	GW	structural waterproof 167
Jointec	GS	seismic expansion joint 168
Jointec	P	perimeter modular 169
Jointec	GD	joint cover 170
Jointec	GDM	joint cover high performance 171
Jointec	GAD	joint cover floor 172
Jointec	GADP	joint cover wall 173
Coprítec	CPM	modular joint 174
Coprítec	CP	joint cover modular 175
Jointec	GC	concrete floors 176
Jointec	GT	industrial floors 178
Jointec	GI-GIL	insert 179



# coflex™ CE

Synthetic material movement joint designed to subdivide a tiled bay area in smaller sections. Coflex CE joint is sized in respect to the tile's thickness and must not rise above the level of the covering surface, it should actually be laid 0,5 ÷ 1 mm below the edge of the tiles. To be installed with the same adhesive used for tiling. The joint must be laid in correspondence with the underlying screed cut. This joint is solely recommended for pedestrian transit as it offers limited protection to the tiles edges. This joint is conceived to compensate only slight compression and sliding movements of the adjacent surfaces.

Suggested flooring bays: 16 m<sup>2</sup> (as per standard UNI 11499:2013) in case of stable surfaces.

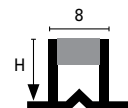

(CE 90\*)



## COFLEX CE-P\* Co-extruded synthetic resin

PVC profile with fair tolerance against main corrosion present in detergents. Applicable for both indoors and outdoors coverings.



	H=mm	Art.		
Material: PVC	7	CE	70	P10/P23
	9	CE	90	P10/P23
	11	CE	110	P10/P23
Infill colour options: Transparent (P10), Cement grey (P23)	13	CE	130	P10/P23
	15	CE	150	P10/P23
Length: 2,70 metres				



# coflex™ CA

Control movement joint in synthetic co-extruded material with a soft visible side and a more rigid fixing flange. Designed to divide large tiled areas in smaller bays. The soft plastic is resistant to most relevant chemicals encountered in tile applications, to weathering, ageing and UV rays. It will remain flexible and resistant to attack from fungus and bacteria. Suitable for internal and external use and maintenance free. It offers only a limited protection to the tiles edges.

Suggested flooring bays 16 m<sup>2</sup> (as per standard UNI 11499:2013).

Typical flooring areas: retail shops, hotels, sporting centers and schools.

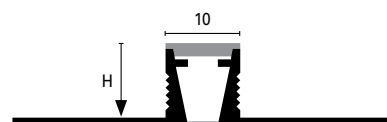

(CA 100\*)

### INSTALLATION:

- Select a joint with the height matching exactly the tile thickness (the joint must not rise above the level of covering surface but should be laid 0,5 ÷ 1 mm below the edge of the tiles).
- Trowel adhesive as normal.
- Align the joint over the screed joint (if not existent, cut the screed for at least 2/3 of its thickness).
- Lay tiles alongside the flanges so that they are solidly embedded and flush with the profile.
- The joint between the tile and the profile to be filled completely with grout.



### COFLEX CA-P\* Co-extruded synthetic resin

Synthetic material profile joint with technical characteristics which offer high elasticity, durability and tolerance to common corrosion. Supplied in different colours to combine with main grout colors and different covering materials. Applicable for both indoor and outdoor coverings.



	H=mm	Art.		
Material:	6	CA	60	P11/P23/P32/P51
Resinflex + Resinil	8	CA	80	P11/P23/P32/P51
	10	CA	100	P11/P23/P32/P51
Colour*: Pure white (P11), Cement grey (P23), Beige (P32), Black (P51)	12,5	CA	125	P11/P23/P32/P51
	15	CA	150	P11/P23/P32/P51
	20	CA	200	P11/P23/P32/P51
Length: 2,70 metres				



# coflex™ CAJ

## INSTALLATION:

- Select a joint with the height matching exactly the tile thickness (the joint must not rise above the level of covering surface but should be laid 0,5 ÷ 1 mm below the edge of the tiles).
- Trowel adhesive as normal.
- Align the joint over the screed joint (if not existent, cut the screed for at least 2/3 of its thickness).
- Lay tiles alongside the flanges so that they are solidly embedded and flush with the profile.
- The joint between the tile and the profile to be filled completely with grout.

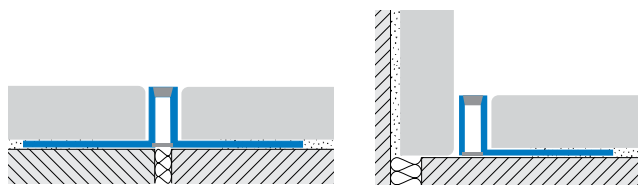

The "invisible" expansion joint. It is considered as such due to its 5 mm top width which makes it look as if were part of the grouting joint. The harder plastic flange guarantees an excellent hold under the tile and will follow its movements in compression and expansion. Suitable for internal and external use and virtually maintenance free.

The soft plastic is resistant to most relevant chemicals encountered in tile applications, to weathering, ageing and UV rays. Designed to divide big tiled areas in smaller bays. It will remain flexible and resistant to attacks of fungus and bacteria. The CAJ model offers a rather limited tile edge protection.

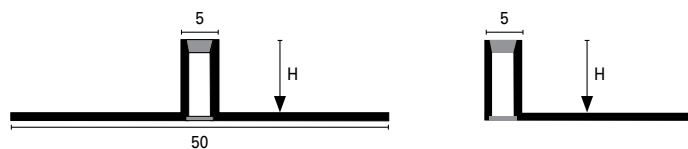

(CAJ 100\*)



## COFLEX CAJ-P\* Co-Extruded synthetic resin

Synthetic material profile joint with technical characteristics which offer high elasticity, durability and tolerance to common corrosion. Supplied in different colours to combine with main grout colours and different covering materials. Applicable for both indoor and outdoor coverings.



	H=mm		Art.	
Material:	4,5	CAJ	45	P11/P23/P32/P51
Resinflex + Resinil	6	CAJ	60	P11/P23/P32/P51
Colour*: Pure white (P11), Cement grey (P23), Dark beige (P32), Black (P51)	8	CAJ	80	P11/P23/P32/P51
	10	CAJ	100	P11/P23/P32/P51
	12,5	CAJ	125	P11/P23/P32/P51
Length: 2,70 metres				
☒ "ultra-thin" line				

## COFLEX CAJP-P23 Perimeter joint in synthetic resin

Profile for finishing floor coverings such as ceramics around the perimeter of a room or next to windows, door frames and thresholds.



Material:	4,5	CAJP	45	P23
Resinflex + Resinil	6	CAJP	60	P23
Colour:	8	CAJP	80	P23
Cement grey (P23)	10	CAJP	100	P23
	12,5	CAJP	125	P23
Length: 2,70 metres				
☒ "ultra-thin" line				





coflex™ CTL

Expansion joint with a metal structure and an infill suitable for sanding and grinding. Good tolerance to chemicals and heavier transit, therefore ideal for porcelain stoneware tile in industrial and commercial areas and for large surfaces in general. Good resistance to diluted acids. The product compensates the floors movements and grants a certain protection to the tile edges, which are constantly solicited by the various types of transit such as trolleys, carriages and so forth. The metallic side flanges of the joint profile have a good hold under the tile and will follow its movements in compression and expansion. The infill hardness is an excellent compromise between the required standards for flexibility and durability. Ideal with marble as it is suitable for grinding and polishing.

Suggested flooring bays 16 m<sup>2</sup> (as per standard UNI 11499:2013) Typical flooring areas: retail shops, hotels, sporting centers and schools.

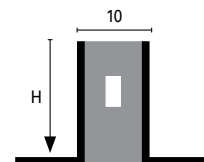

(CTL 150\*)



**COFLEX CTL-AN\* Natural aluminium + infill suitable for grinding**

This profile joint is adopted in projects such as car showrooms and workshops facilities. It is the most popular finish as it combines edge protection and resistance along with a modern appearance. The choice of the brass or stainless steel model should be preferred for outdoor applications or in environments subject to higher mechanical or chemical stresses.



	H=mm		Art.	
Material: Aluminium	8	CTL	80	AN 51/23/32
	10	CTL	100	AN 51/23/32
	12,5	CTL	125	AN 51/23/32
Finish: Natural (AN)	15	CTL	150	AN 51/23/32
	20	CTL	200	AN 51/23/32
	25	CTL	250	AN 51/23/32
Interno: EPDM Black (51), Cement grey (23), Beige (32)	30	CTL	300	AN 51/23/32
	Length: 2,70 metres			

**COFLEX CTL-ON\* Natural brass + infill suitable for grinding**

Well resistant to chemical aggression and mechanical impact. Suitable for internal and external use. Typical for building projects such as shopping centres, public buildings and luxurious reception areas where more traditional materials would be used.



Material: Brass	8	CTL	80	ON 51/23/32
	10	CTL	100	ON 51/23/32
	12,5	CTL	125	ON 51/23/32
Finish: Natural (ON)	15	CTL	150	ON 51/23/32
	20	CTL	200	ON 51/23/32
	25	CTL	250	ON 51/23/32
Interno: EPDM Black (51), Cement grey (23), Beige (32)	30	CTL	300	ON 51/23/32
	Length: 2,70 metres			

**COFLEX CTL-IL\* Stainless steel polished AISI 304 - DIN 1.4301 + Insert suitable for grinding**

Cold rolled profile manufactured from Polished Stainless steel AISI 304. It is recommended for use in hospitals, food preparation areas, commercial kitchens, warehouses and factories. Also highly suitable for use on projects that require a clean modern look. Typical projects would be heavy transit areas such as commercial/shopping centres and restaurants. Internal and external use with an excellent resistance to corrosion.



Material: Stainless steel AISI 304	8	CTL	80	IL 51/23/32
	10	CTL	100	IL 51/23/32
	12,5	CTL	125	IL 51/23/32
Finish: Polished (IL)	15	CTL	150	IL 51/23/32
	20	CTL	200	IL 51/23/32
	25	CTL	250	IL 51/23/32
Interno: EPDM Black (51), Cement grey (23), Beige (32)	30	CTL	300	IL 51/23/32
	Length: 2,70 metres			



coflex™ CB

**COFLEX CB** is composed of a twin double metal profile to host the internal rubber seal. This product has been designed to ensure a certain grade of protection to the tile and relative work load it may have to bear. The synthetic rubber insert efficiently compensates and absorbs flooring movements along with the covering material. COFLEX CB is suitable to bear distributed weights and tensions. Select a joint with the height matching exactly the tile thickness, the joint must not rise above the level of covering surface but should be laid 0,5 ÷ 1 mm below the edge of the tiles.  
Suggested flooring bays 16-25 m<sup>2</sup> (as per standard UNI 11499:2013).  
Typical flooring areas: retail shops, hotels, sporting centers and schools.

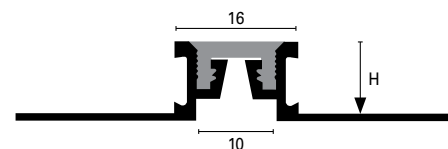

(CB 100\*)

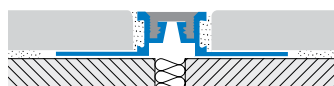

**COFLEX CB-AN\* Aluminium + synthetic insert**

The aluminium profile is generally advised for indoor laying jobs and in areas which are less subject to mechanical impact and stress.



	H=mm		Art.	
Material: Aluminium extruded	8	CB	80	AN 23/51
	10	CB	100	AN 23/51
	12,5	CB	125	AN 23/51
	15	CB	150	AN 23/51
Finish: Natural (AN)	20	CB	200	AN 23/51
	Insert*: Resinil + Resinflex Cement grey (23), Black (51)			
Length: 2,70 metres				

**COFLEX CB-ON\* Brass + synthetic insert**

Brass offers characteristics of high tolerance to mechanical impact and corrosion. Suitable for both indoor and outdoor applications conferring a pleasant appearance and a classic finish to the coverings.



Material: Brass extruded	8	CB	80	ON 23/51
	10	CB	100	ON 23/51
	12,5	CB	125	ON 23/51
	15	CB	150	ON 23/51
Finish: Natural (ON)	20	CB	200	ON 23/51
	Insert*: Resinil + Resinflex Cement grey (23), Black (51)			
Length: 2,70 metres				

**COFLEX CBI 10 P\* Spare synthetic insert**

Made of soft synthetic resin. In case it should look worn out over time just replace the insert with a slight leverage starting from the metal profile ends.

	Colour		Art.	
Material: Resinil + Resinflex	23 / 51	CBI	10	P23/P51
Length: 2,70 metres				



# coflex™ CBL

**COFLEX CBL** is composed of a twin double metal profile to host the internal rubber seal. This product has been designed to ensure a certain grade of protection to the tile and relative work load it may have to bear. The synthetic rubber insert efficiently compensates and absorbs flooring movements along with the covering material. COFLEX CBL is suitable to bear distributed weights and tensions. Select a joint with the height matching exactly the tile thickness, the joint must not rise above the level of covering surface but should be laid 0,5 ÷ 1 mm below the edge of the tiles.  
Suggested flooring bays 16-25 m<sup>2</sup> (as per standard UNI 11499:2013).  
Typical flooring areas: retail shops, hotels, sporting centers and schools.

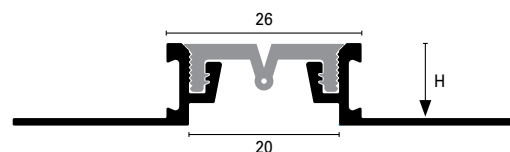

(CBL 100\*)



### COFLEX CBL-AN\* Aluminium + synthetic insert

The aluminium profile is generally advised for indoor laying jobs and in areas which are less subject to mechanical impact and stress.



	H=mm		Art.	
Material: Aluminium extruded	8	CBL	80	AN 23/51
	10	CBL	100	AN 23/51
	12,5	CBL	125	AN 23/51
	15	CBL	150	AN 23/51
Finish: Natural (AN)	20	CBL	200	AN 23/51
	Insert*: Resinil + Resinflex Cement grey (23), Black (51)			
Length: 2,70 metres				

### COFLEX CBL-ON\* Brass + synthetic insert

Brass offers characteristics of high tolerance to mechanical impact and corrosion. Suitable for both indoor and outdoor applications conferring a pleasant appearance and a classic finish to the coverings.



Material: Brass extruded	8	CBL	80	ON 23/51
	10	CBL	100	ON 23/51
	12,5	CBL	125	ON 23/51
	15	CBL	150	ON 23/51
Finish: Natural (ON)	20	CBL	200	ON 23/51
	Insert*: Resinil + Resinflex Cement grey (23), Black (51)			
Length: 2,70 metres				

### COFLEX CBI 20 P\* Synthetic insert spare part

Made of soft synthetic resin. In case it should look worn out over time just replace the insert with a slight leverage starting from the metal profile ends.

	Colour		Art.	
Material: Resinil + Resinflex	23 / 51	CBI	20	P23/P51
Length: 2,70 metres				



Technical sliding expansion joint in metal for thin bed applications. It ensures characteristics of high resistance to loads and good joint control over time, with a pleasant appearance .

Its two metal parts slide one into the other by  $\pm 2$  mm thus ensuring compensation of expansion and contraction movements of the adjacent floors.

Supplied ready assembled in a "neutral position" and kept in the right position by a linking elastic seal on its lower part.

coflex™ CK

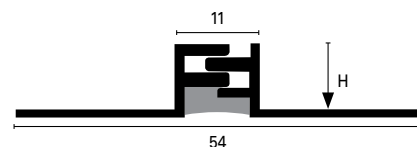

(CK 100\*)



#### COFLEX CK-ON Natural brass

Brass offers characteristics of high tolerance to mechanical impact and chemical agents. Suitable for both indoor and outdoor applications conferring a pleasant appearance or classic finish to the coverings. Through contact with moisture or chemical agents, brass may oxidize on exposed surfaces. In this case it is sufficient to buff it with a conventional polisher to return to its original shine.



	H=mm	Art.		
Material: Brass extruded	10 12,5	CK CK	100 125	ON ON
Finish: Natural (ON)				
Length: 2,70 metres				

#### COFLEX CK-AN Aluminium natural

The aluminium profile is generally advised for indoor laying jobs and in areas which are less subject to mechanical impact.



	H=mm	Art.		
Material: Aluminium extruded	10 12,5	CK CK	100 125	AN AN
Finish: Natural (AN)				
Length: 2,70 metres				





Technical sliding expansion joint in metal for deep bed applications. It ensures characteristics of high resistance to loads and good joint control over time, with a pleasant appearance.

Its two metal parts slide one into the other by  $\pm 2$  mm, thus ensuring compensation of expansion and contraction movements of the adjacent floors.

Complete profile not assembled.

The foam infill to be assembled only right before installation.

Suggested flooring bays 16-25 m<sup>2</sup> (as per standard UNI 11499:2013).

Typical flooring areas: retail shops, hotels, sporting centers and schools.

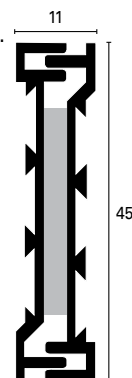

**coflex™ CKM**

**INSTALLATION:**

- Assemble the two lateral metal sides with the provided spacing bi-adhesive foam right before installation.
- Align and position the joint profile in the screed.
- Proceed with tiling as normal.
- Complete the covering installation job by levelling the joint profile down.
- Grout over the covering including the small gaps between the tiles and joint.

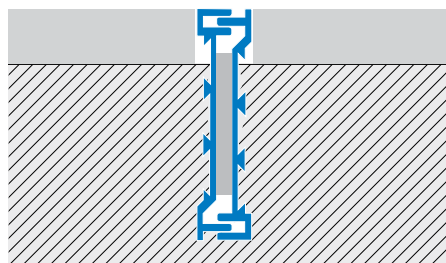

**COFLEX CKM 450 ON Natural brass**

Brass features a high tolerance to mechanical impact and chemical agents, yet still maintaining an elegant top finish look. It is applicable for either indoor or outdoor jobs. Moreover, suitable for public work projects and leisure areas where more classic materials for paving are preferred.



	H=mm	Art.		
Material: Brass extruded	45	CKM	450	ON
Finish: Natural (ON)				
Length: 2,70 metres				

**COFLEX CKM 450 AN Aluminium natural**

Extruded aluminium profile, to convey a modern look to the paving job. For outdoors or environments subject to remarkable mechanical or chemical impacts we recommend to prefer the brass option.



Material: Aluminium extruded	45	CKM	450	AN
Finish: Natural (AN)				
Length: 2,70 metres				



# coflex™ CMB

The lateral parts of the base module are in Resinil, while the linking insert is in softer synthetic resin Resinflex.

The system can be adapted to virtually any given height, thanks to the modular clip device and to the use of the available extensions, with a minimum 30 mm height and subsequent clicks at 15-20 mm height intervals. In correspondence with screed-bed cuts and joints, it is always advisable to provide for an expansion joint also at floor level, such as a Coflex CA type, to prevent tensions accumulating on the surface along the underlying cut, with consequent cracking of the floor surfaces.

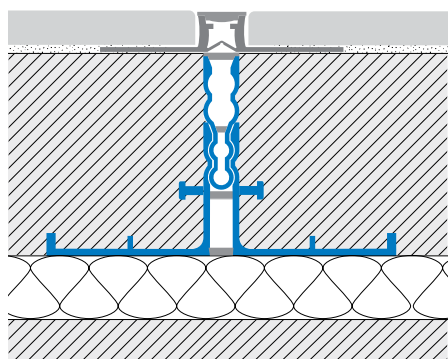

This movement joint profile consists of a Resinil wide base flange which can be fitted under the mortar or screed bedding to subsequently host the synthetic resin co-extruded profile insert, with an extension piece for adaptation to the mortar bed height. Conceived to properly subdivide the screed, according to the minimum bays provided in the project and in correspondence of the cast-retakes. It works also as form-work, as its wide lateral flanges keeps it easily in the right position for cement casting.

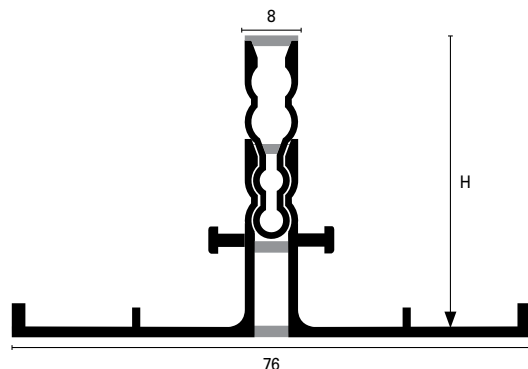

## COFLEX CMB-P23 Co-extruded modular synthetic resin

The soft yet resistant plastic can withstand common chemical agents present during the work phase, with high tolerance to ageing and UV rays. The product always maintains its main characteristics of flexibility and resistance to bacteria and fungus. Suitable for both indoor and outdoor applications. It offers limited protection to the tiles edges.

Base, module CM and extension are available also separately. For a description of Art. CM see page 153.



	H=mm	Art.		
Material:	30	CMB	300	P Open base
Resinflex + Resinil	30	CMB	300	P23 Close base
Colour:	45	CMB	450	P23 Base+Module+CM
Cement grey (P23)	60	CMB	600	P23 Base+exten.+CM
Length: 2,70 metres				



**COFLEX CM** series is a modular system for deep bed installations which enables the realisation of movement joints whose height perfectly matches the thickness of the screed + the tile covering. It is composed of a synthetic resin co-extruded profile the base module piece CM 300 P, with a visible section made of full-coloured softer resin material, and of a twin-profile CM 200 P open in its upper part, which works as the former clip extension piece.

Suggested flooring bays 16 m<sup>2</sup> (as per standard UNI 11499:2013)  
 Typical flooring areas: retail shops, hotels, sporting centers and schools.

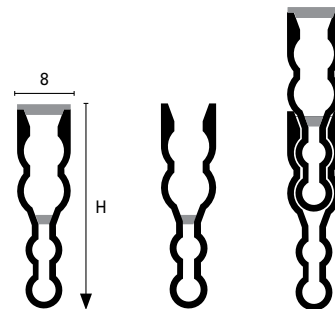

**coflex™ CM**

**INSTALLATION:**

- Align and position the joint profile in screed cut/joint so that it protrudes slightly above the screed level.
- Proceed with tiling as normal.
- Complete the covering installation job by levelling the joint profile down until its solidly imbedded and flush with the tile edge.
- Grout over the covering including the small gaps between the tiles and joint.

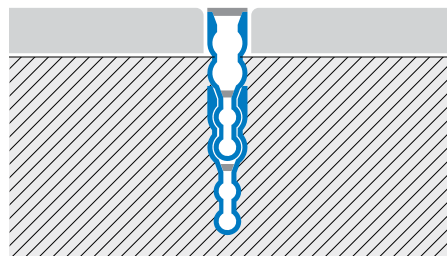

**COFLEX CM-P\* Co-extruded modular synthetic resin**

The soft plastic is resistant to most relevant chemicals encountered in tile applications, to weathering, ageing and UV rays. It will remain flexible and resistant to attack from fungus and bacteria. Suitable for internal and external use and maintenance free. It offers only a limited protection to the tiles edges. The system virtually allows one to adapt to any given screed height, thanks to the modular clip device with extensions. The extension rises the joint height by 20 mm with the first click and by 15 mm with the second one.



	H=mm	Art.		
Material:	30	CM	300	P23
Resinflex + Resinil	30	CM	300	P51
Colour:	30	CM	300	P61
Cement grey (P23), Black (P51), Klinker red (P61)				
Length: 2,70 metres				

	H=mm	Description	Art.		
	15 ÷ 20	Extension modular	CM	200	P



Synthetic material movement joint designed to subdivide a tiled bay area into smaller sections. This joint is solely recommended for pedestrian transit as it offers limited protection to the tiles edges. Conceived to compensate only slight compression and sliding movements at the screed- substrate level.

Suggested flooring bays 16 m<sup>2</sup> (as per standard UNI 11499:2013) Typical flooring areas: retail shops, hotels, sporting centers and schools.

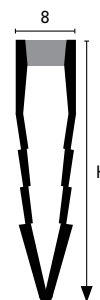

**coflex™ CF**

**INSTALLATION:**

- Align and position the joint profile in screed cut/joint so that it protrudes slightly above the screed level.
- Proceed with tiling as normal.
- Complete the covering installation job by levelling the joint profile down until its solidly imbedded and flush with the tile edge.
- Grout over the covering including the small gaps between the tiles and joint.

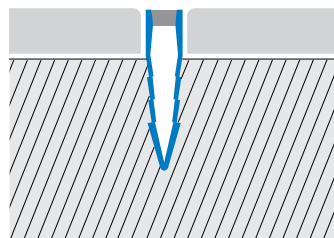

**COFLEX CF-P\* Co-extruded synthetic resin**

PVC profile with fair tolerance against main corrosion present in detergents. Applicable both indoors and outdoors.



	H=mm		Art.	
Material: PVC	23	CF	230	P10/P23
	35	CF	350	P10/P23
	45	CF	450	P10/P23
Colour: Grey + Infill Transparent (P10), Cement grey (23)				
Length: 2,70 metres				





Synthetic material movement joint designed to subdivide a tiled bay area into smaller sections. The layer may utilize one or more connecting extension pieces so as to match higher mortar bedding. This joint is recommended solely for pedestrian transit as it offers limited protection to the tile edges. Conceived to compensate only slight compression and sliding movements at the screed- substrate level.

Suggested flooring bays 16 m<sup>2</sup> (as per standard UNI 11499:2013) Typical flooring areas: retail shops, hotels, sporting centers and schools.

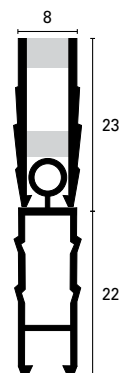

**coflex™ CD**

**INSTALLATION:**

- Align and position the joint profile in screed cut/joint so that it protrudes slightly above the screed level.
- Proceed with tiling as normal.
- Complete the covering installation job by levelling the joint profile down until its solidly imbedded and flush with the tile edge.
- Grout over the covering including the small gaps between the tiles and joint.

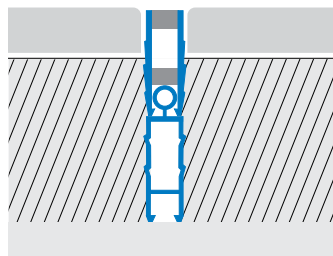

**COFLEX CD-P\* Co-extruded synthetic resin**

PVC profile with fair tolerance against main corrosion present in detergents. Applicable both indoors and outdoors.



	H=mm		Art.	
Material: PVC	23	CD	230	P10/P23
	23	CD	220	P
Colour: Grey Transparent (P10), Cement grey (P23)				
Length: 2,70 metres				



Twin metal plate - grindable infill expansion joint, specifically conceived for terrazzo floor laying, marble, granite, limestone covering jobs necessitating sanding, grinding and/or polishing finish treatments on site, which must necessarily be borne easily by the joints as well. Suggested flooring bays 16 m<sup>2</sup> (as per standard UNI 11499:2013) Typical flooring areas: retail shops, hotels, sporting centers and schools.

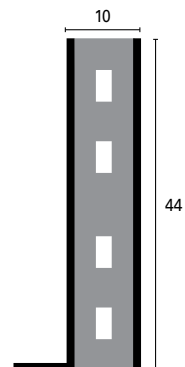

**coflex™ CTM**

**N.B.:** in the photo the joint CTM lateral wing has been removed.

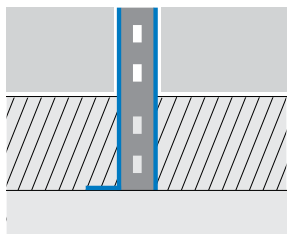

**COFLEX CTM-ON\* Natural brass + EPDM**

Brass features a good resistance to mechanical impacts and to diluted chemicals yet still maintaining an elegant top finish look. It is applicable for either indoor or outdoor jobs.



	H=mm	Colour	Art.		
Material: Brass	44	Black 51	CTM	440	ON 51/23/32
Finish: Natural (ON)					
Insert: EPDM Black (P51), Cement grey (P23), Beige (P32)					
Length: 2,70 metres					

**COFLEX CTM-IL\* Stainless steel polished AISI 304 - DIN 1.4301 + EPDM**

The stainless-steel version is particularly suitable for hospital sector and food processing areas for it guarantees a higher tolerance to corrosion. Good mechanical resistance. It is applicable for either indoor or outdoor jobs.



Material: Stainless steel AISI 304	44	Black 51	CTM	440	IL 51/23/32
Finish: Polished (IL)					
Insert : EPDM Black (P51), Cement grey (P23), Beige (P32)					
Length: 2,70 metres					



# coflex™ CR

The modular combination system called "Clip System" allows one to match all possible tile thicknesses still with the same base module, thus resulting in both a time saver and actual material saved. The KJ – Kerajolly profile functions as the perforated side flanges for the laying so to adapt to the different heights of the tiles for wall and floor coverings (e.g. floor height 12,5 mm - wall covering height 8 mm). KERAJOLLY small off-cuts can also be utilized for this purpose.

E.g. of COFLEX assembly for installation: if the thickness of a tile is of 10 mm, utilize the KERAJOLLY KJ 8 mm height profile (page 101) as the combination with the CR base module raises the height by 2 mm matching it then to the 10 mm tile thickness. .

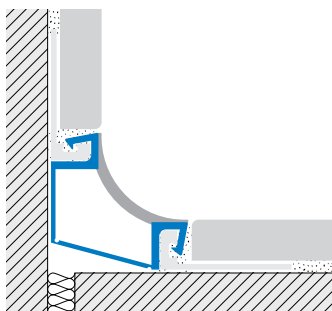

**COFLEX CR** is expressly conceived to perimeter joint wall/floor coverings supplying sufficient elasticity for the expansion and meeting the cove base hygienic corner cleanliness requirements. It also serves as a sound breaker of the covered surfaces so that trampling of foot steps is not transmitted to the adjacent walls.

**COFLEX CR** consists of a main curved co-extruded hard/soft combination module Art. CR 16 with Art. series KJ inserts which slide into CR 16 tracks allowing it to adapt to any covering height and providing a perfect anchoring to the tiled covering.

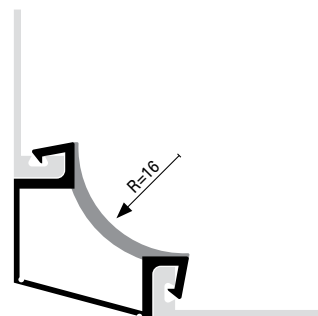

## COFLEX CR 16 P\* Co-Extruded Synthetic Resin

Main frame co-extruded profile with soft internal cove supplied in different colours. The profile flange inserts are supplied separately as the specific required height needs to be provided.



## COFLEX CR Raccordi di derivazione

End caps, internal jointing corner pieces, external and tri-axis jointing pieces. These special pieces help the layer finish off the perimeter laying for two way and three way connections in a most precise and appropriate manner.



	H=mm	Colour	Art.		
Material: Resinflex + Resinil	modular	Pure white P11	CR	16	P11/P23/P32
Radius: 16mm					
Colour: Pure white (P11), Cement grey (P23), Beige (P32)					
Length: 2,70 metres					

	Description	Art.	
	Inner corner	CRI	+ Colour
	Outer corner	CRE	+ Colour
	Three way junction	CRT	+ Colour
	Endplug	CRF	+ Colour



jointec™ GE

Aluminium body structural expansion joints with synthetic rubber insert. Designed to bear structural movements of large sized buildings or compounds of buildings. They are installed over the spaces existing between two semi-detached parts of a building of smaller entity or between different beam bays. They can connect and close these inter-spaces adjusting themselves up-wards, downwards and even transversally, according to the shrinkage-settlement movements of the whole building, either cyclic or permanent. Within the flooring bays frame created with the structural joints, a further surface subdivision with a suitable pattern of movement / expansion joints should be always provided for. See relevant indications on page 263.

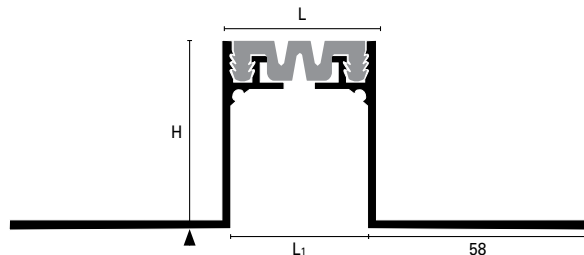

(GE 500 AN\*)

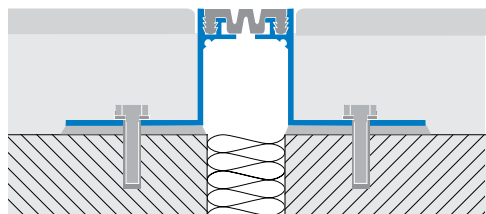

**JOINTEC GE-AN\* Natural aluminium 44 mm width - gap 38 mm**

Extruded aluminium profile. Good mechanical and chemical resistance over time. For outdoor utilization the similar joint type Jointec GM in brass is advisable.

Highly elastic 37 mm wide synthetic rubber insert.

Standard version or smooth version available on request (pag. 179).



**JOINTEC GEL-AN\* Aluminium width 54 mm - gap 48 mm**

Extruded aluminium profile. Good mechanical and chemical resistance over time. For outdoor utilization the similar joint type Jointec GM in brass is advisable.

Highly elastic 47 mm wide synthetic rubber insert.



	H=mm	L=mm	L1=mm	Art.		
Material: Aluminium extruded	20 50	44 44	38 38	GE GE	200 500	AN 51/23* AN 51/23*
Finish: Natural (AN)						
Insert*: Resinprene Black (P51 - suggested), Cement grey (P23)						
Length: 4,00 metres						

\*\*S" for the smooth insert version

Material: Aluminium extruded	20 50	54 54	48 48	GEL GEL	200 500	AN 51/23 AN 51/23
Finish: Natural (AN)						
Insert: Resinprene Black (P51 - suggested), Cement grey (P23)						
Length: 4,00 metres						





jointec™ GR

**INSTALLATION:**

- Position the metal insert into the lateral flanges.
- Slip the rubber infill into the metal insert before aligning the expansion joint in site.
- It is advisable to protect the rubber with some adhesive tape to avoid any cement spot.
- Fasten the lateral flanges into the substrate with suitable fixing plugs (7 every linear meter, i.e. one every 30 cm, proceeding parallel on the two sides).
- Lay then the screed over the structural joint flanges and tile as normal.

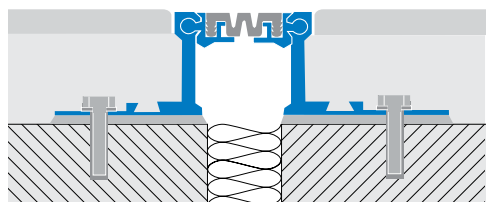

**JOINTEC GR-AN\* Natural aluminium 68 mm width - gap 46 mm**

Extruded aluminium profile. Good mechanical and chemical resistance over time. For outdoor utilization the similar joint type Jointec GM in brass is advisable. Highly elastic 37 mm wide synthetic rubber insert. Insert: standard version or smooth version available on request (pag. 179).



**JOINTEC GRL-AN\* Aluminium width 78 mm - gap 56 mm**

Extruded aluminium profile. Good mechanical and chemical resistance over time. For outdoor utilization the similar joint type Jointec GM in brass is advisable. Highly elastic 47 mm wide synthetic rubber insert.



Aluminium body structural expansion joints with a pivotal movement between the metal flanges and a synthetic rubber insert. Designed to bear structural movements of large sized buildings or compounds of buildings. They are installed over the spaces existing between two semi-detached parts of a building of smaller entity or between different beam bays. They can connect and close these inter-spaces adjusting themselves up-wards, downwards and even transversally, according to the shrinkage-settlement movements of the whole building, either cyclic or permanent. Within the flooring bays frame created with the structural joints, a further surface subdivision with a suitable pattern of movement / expansion joints should be always provided for.

See relevant indications on page 263.

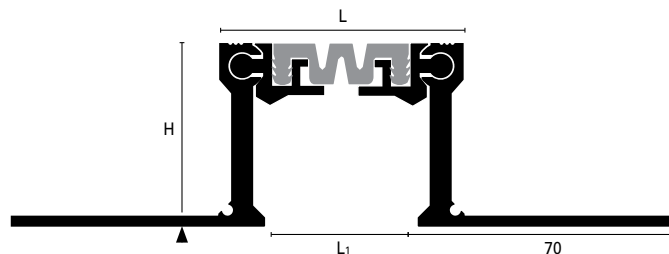

(GR 500 AN\*)

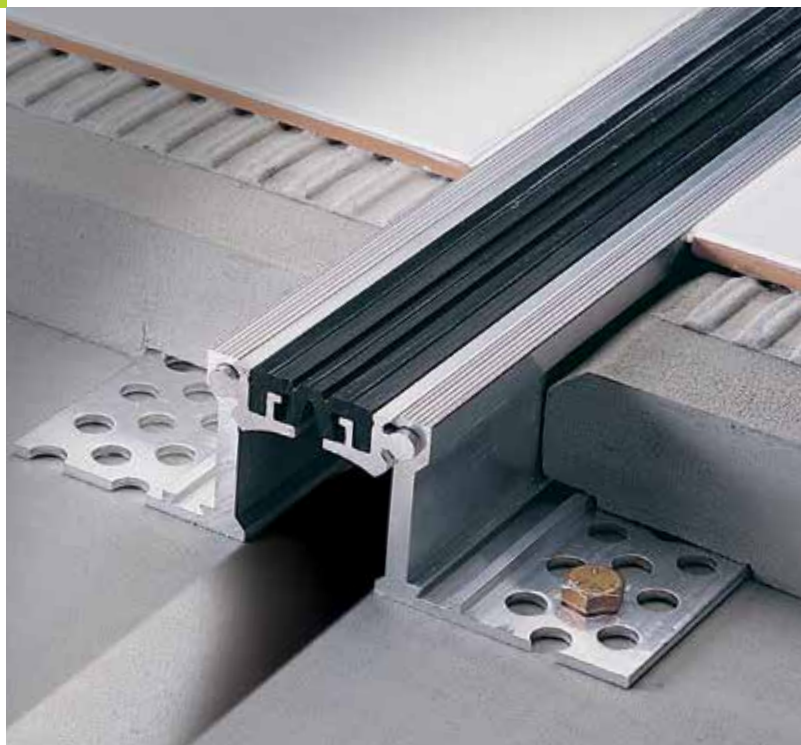

	H=mm	L=mm	L1=mm	Art.		
Material: Aluminium extruded	20	68	46	GR	200	AN 51/23*
	50	68	46	GR	500	AN 51/23*
Finish: Natural (AN)	70	68	46	GR	700	AN 51/23*
Insert*: Resinprene Black (P51 - suggested), Cement grey (P23)						
Length: 4,00 metres						

\*\*S" for the smooth insert version

Material: Aluminium extruded	20	78	56	GRL	200	AN 51/23
	50	78	56	GRL	500	AN 51/23
Finish: Natural (AN)	70	78	56	GRL	700	AN 51/23
Insert: Resinprene Black (P51 - suggested), Cement grey (P23)						
Length: 4,00 metres						



# jointec™ GRM

## INSTALLATION:

- Position the metal insert into the lateral flanges.
- Slip the rubber infill into the metal insert before aligning the expansion joint in site.
- It is advisable to protect the rubber with some adhesive tape to avoid any cement spot.
- Fasten the lateral flanges into the substrate with suitable fixing plugs (7 every linear meter, i.e. one every 30 cm, proceeding parallel on the two sides).
- Lay then the screed over the structural joint flanges and tile as normal.

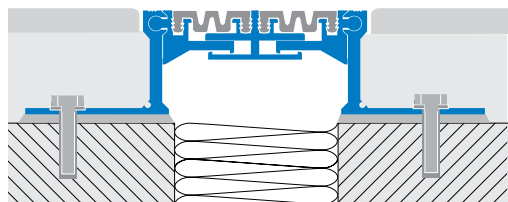

**JOINTEC GRM-AN\* Natural Aluminium 105 mm width - gap 90 mm**  
 Extruded aluminium profile. Good mechanical and chemical resistance over time. For outdoor utilization the similar joint type Jointec GM in brass is advisable.

Insert: standard version or smooth version available on request (page 179).



Aluminium body structural expansion joints with a pivotal movement between the metal flanges and a synthetic rubber insert. Designed to bear structural movements of large sized buildings or compounds of buildings. They are installed over the spaces existing between two semi-detached parts of a building of smaller entity or between different beam bays. They can connect and close these interspaces adjusting themselves up-wards, downwards and even transversally, according to the shrinkage-settlement movements of the whole building, either cyclic or permanent. Within the flooring bays frame created with the structural joints, a further surface subdivision with a suitable pattern of movement / expansion joints should be always provided for.

See relevant indications on page 263.

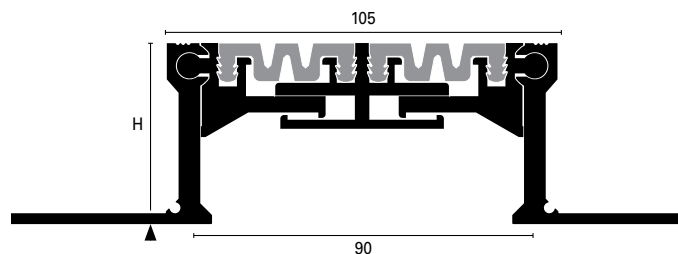

(GRM 500 AN\*)



	H=mm	L=mm	L1=mm	Art.		
Material: Aluminium extruded	50 70	105 105	90 90	GRM GRM	500 700	AN 51/23* AN 51/23*
Finish: Natural (AN)						
Insert: Resinprene Black (P51 - suggested), Cement grey (P23)						
Length: 4,00 metres						

\*\*S\*\* for the smooth insert version



jointec™ GM

Modular structural joint adjustable to different heights with visible upper part in either brass or aluminium and lower module in aluminium. Designed to bear structural movements of large sized buildings. They are installed over the spaces existing between two semi-detached parts of a building of smaller entity or between different beam bays. They can connect and close these inter-spaces adjusting themselves up-wards, downwards and even transversally, according to the shrinkage-settlement movements of the building, either cyclic or permanent. Within the flooring bays frame created with the structural joints, a further surface subdivision with a suitable pattern of movement joints should be always provided for. See relevant indications on page 263.

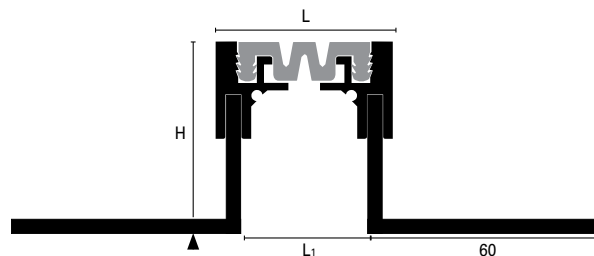

(GM 500\*)

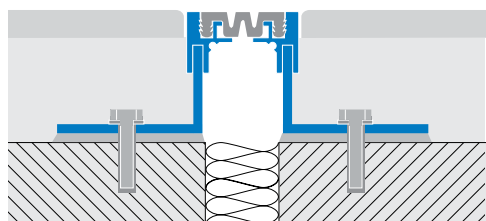

**JOINTEC GM/GML-ON\* Brass 50 and 60 mm width**

Extruded profile joint with visible top part in brass and inferior part in aluminium. High resistance to chemical agents and mechanical impact over time. Suitable for both indoor and outdoor laying. Highly elastic 37 or 47 mm wide synthetic rubber insert.

Out-of-standard heights can be supplied on request thanks to the system modularity.

Insert: standard version or smooth version available on request (pag. 179).



	H=mm	L=mm	L1=mm	Art.		
Material: Brass extruded	35	50	38	GM	350	ON 51/23*
Finish: Natural (ON)	50	50	38	GM	500	ON 51/23*
Insert*: Resinprene - Black (P51), Cement grey (P23)	75	50	38	GM	750	ON 51/23*
Length: 3,00 metres						

\*\*"S" for the smooth insert version

Material: Brass extruded	35	60	48	GML	350	ON 51/23
Finish: Natural (ON)	50	60	48	GML	500	ON 51/23
Insert: Resinprene - Black (P51 - suggested), Cement grey (P23)	75	60	48	GML	750	ON 51/23
Length: 3,00 metres						

**JOINTEC GM/GML-AN\* Aluminium 50 e 60 mm width**

Extruded profile joint entirely in aluminium. Good resistance to chemical agents and mechanical impact over time. Highly elastic 37 or 47 mm wide synthetic rubber insert.

Out-of-standard heights can be supplied on request thanks to the system modularity.

Insert: standard version or smooth version available on request (pag. 179).



Material: Aluminium	35	50	38	GM	350	AN 51/23*
Finish: Natural (AN)	50	50	38	GM	500	AN 51/23*
Insert*: Resinprene - Black (P51 - suggested), Cement grey (P23)	75	50	38	GM	750	AN 51/23*
Length: 3,00 metres						

\*\*"S" for the smooth insert version

Material: Aluminium	35	60	48	GML	350	AN 51/23
Finish: Natural (AN)	50	60	48	GML	500	AN 51/23
Insert: Resinprene - Black (P51 - suggested), Cement grey (P23)	75	60	48	GML	750	AN 51/23
Length: 3,00 metres						

**JOINTEC GM/GML-IL\* Stainless steel 50 e 60 mm width**

Aluminium profiles with a stainless steel covered aluminium structure for improved aesthetics, durability and increased resistance to most diluted chemical products. The profile is not perfectly corresponding with the above section.

Insert: standard version or smooth version available on request (pag. 179).



Material: Aluminium + Stainless steel AISI 304	35	50	38	GM	350	IL 51/23*
Finish: Polished (IL)	50	50	38	GM	500	IL 51/23*
Insert*: Resinprene - Black (P51 - suggested), Cement grey (P23)	75	50	38	GM	750	IL 51/23*
Length: 2,70 metres						

\*\*"S" for the smooth insert version

Material: Aluminium + Stainless steel AISI 304	35	60	48	GML	350	IL 51/23
Finish: Polished (IL)	50	60	48	GML	500	IL 51/23
Insert: Resinprene - Black (P51 - suggested), Cement grey (P23)	75	60	48	GML	750	IL 51/23
Length: 2,70 metres						



Sliding structural expansion joint entirely realised in aluminium. Designed to bear structural movements of large sized buildings or compounds of buildings.

They are installed over the spaces existing between two semi-detached parts of a building of smaller entity or between different beam bays. They can connect and close these inter-spaces adjusting themselves up-wards, downwards and even transversally, according to the shrinkage-settlement movements of the whole building, either cyclic or permanent.

# jointec™ GAL

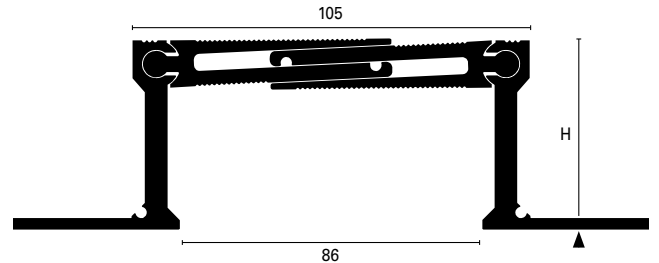

(GAL 500 AN)

The horizontal sliding components allow the movement and avoid dust and dirt accumulation.

Within the flooring bays frame created with the structural joints, a further surface subdivision with a suitable pattern of movement / expansion joints should be always provided for. See relevant indications on page 263.

### INSTALLATION:

- Assemble the joint inserting the three horizontal components within the two lateral flanges.
- Align properly the expansion joint using the provided pre-alignment bracket touching the flanges (point 0).
- Fasten the lateral flanges into the substrate with suitable fixing plugs (7 each linear meter, i.e. one every 30 cm, proceeding parallel on the two sides).
- Lay then the screed over the structural joint flanges and tile as normal.

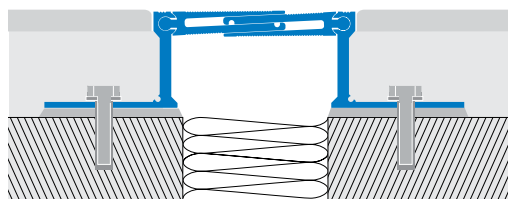

**JOINTEC GAL-AN Aluminium Aluminium 105 mm width - gap 86 mm**  
Extruded aluminium profile. Good mechanical and chemical resistance over time. For outdoor utilization the similar joint type Jointec GM in brass is advisable. Floor use.



	H=mm	L=mm	L1=mm	Art.		
Material: Aluminium extruded	20	105	86	GAL	200	AN
	50	105	86	GAL	500	AN
Finish: Natural (AN)	70	105	86	GAL	700	AN
Length: 4,00 metres						





# jointec™ GA

Sliding structural expansion joint entirely realised in aluminium. Designed to bear structural movements of large sized buildings or compounds of buildings. They are installed over the spaces existing between two semi-detached parts of a building of smaller entity or between different beam bays. They can connect and close these inter-spaces adjusting themselves up-wards, downwards and even transversally, according to the shrinkage-settlement movements of the whole building, either cyclic or permanent. The horizontal sliding components allow the movement and avoid dust and dirt accumulation.

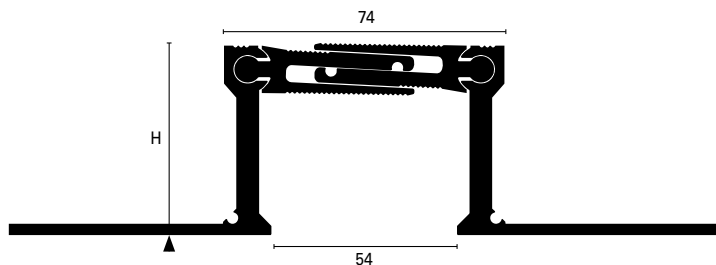

(GA 500 AN)

Within the flooring bays frame created with the structural joints, a further surface subdivision with a suitable pattern of movement / expansion joints should be always provided for. See relevant indications on page 263.

### INSTALLATION:

- Assemble the joint inserting the two horizontal components within the two lateral flanges.
- Align properly the expansion joint using the provided pre-alignment bracket touching the flanges (point 0).
- Fasten the lateral flanges into the substrate with suitable fixing plugs (7 each linear meter, i.e. one every 30 cm, proceeding parallel on the two sides).
- Lay then the screed over the structural joint flanges and tile as normal.

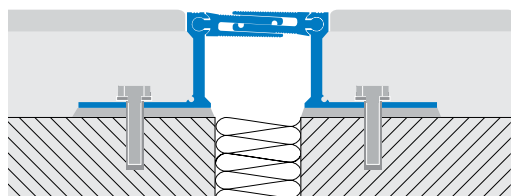

### JOINTEC GA-AN Aluminium 74 mm width - gap 54 mm

Extruded aluminium profile. Good mechanical and chemical resistance over time. For outdoor utilization the similar joint type Jointec GM in brass is advisable. Floor use.



	H=mm	L=mm	L1=mm	Art.		
Material: Aluminium extruded	20	74	54	GA	200	AN
	50	74	54	GA	500	AN
	70	74	54	GA	700	AN
Finish: Natural (AN)						
Length: 4,00 metres						



# jointec™ GALP

The horizontal sliding components allow the movement and avoid dust and dirt accumulation. Within the flooring bays frame created with the structural joints, a further surface subdivision with a suitable pattern of movement / expansion joints should be always provided for. See relevant indications on page 263.

### INSTALLATION:

- Assemble the joint inserting the three horizontal components within the two lateral flanges.
- Align properly the expansion joint.
- Fasten the lateral flanges into the substrate with suitable fixing plugs (Each metre, i.e. one every 30 cm).
- Lay then the screed over the structural joint flanges and tile as normal.

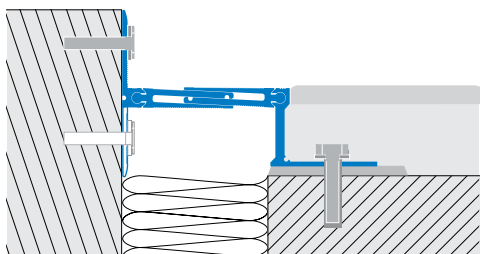

### JOINTEC GALP-AN Aluminium width 105 mm - gap 95 mm

Extruded aluminium profile. Good mechanical and chemical resistance over time. For outdoor utilization the similar joint type Jointec GM in brass is advisable. Installation between floor and wall.



Sliding structural expansion joint entirely realised in aluminium. Designed to bear structural movements of large sized buildings or compounds of buildings. To be installed between floor and wall. They are installed over the spaces existing between two semi-detached parts of a building of smaller entity.

They can connect and close these inter-spaces adjusting themselves upwards, downwards and even transversally, according to the shrinkage-settlement movements of the whole building, either cyclic or permanent. It can be also used putting the fixing flange on the wall downwards.

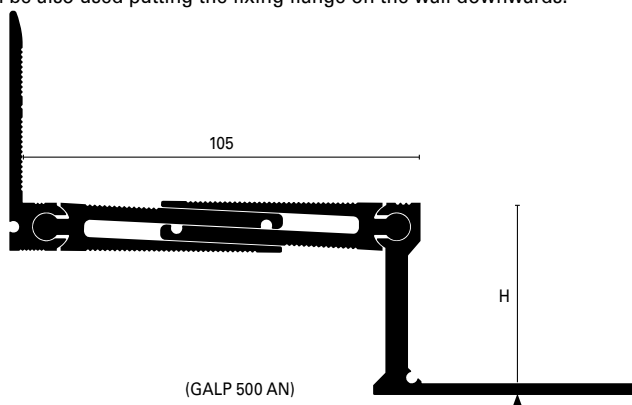

	H=mm	L=mm	Art.		
Material: Aluminium extruded	20	105	GALP	200	AN
	50	105	GALP	500	AN
	70	105	GALP	700	AN
Finish: Natural (AN)					
Length: 4,00 metres					



# jointec™ GAP

Sliding structural expansion joint entirely realised in aluminium. Designed to bear structural movements of large sized buildings or compounds of buildings. To be installed between floor and wall. They are installed over the spaces existing between two semidetached parts of a building of smaller entity or between different beam bays. They can connect and close these inter-spaces adjusting themselves up-wards, downwards and even transversally, according to the shrinkage-settlement movements of the whole building, either cyclic or permanent. It can be also used putting the fixing flange on the wall downwards.

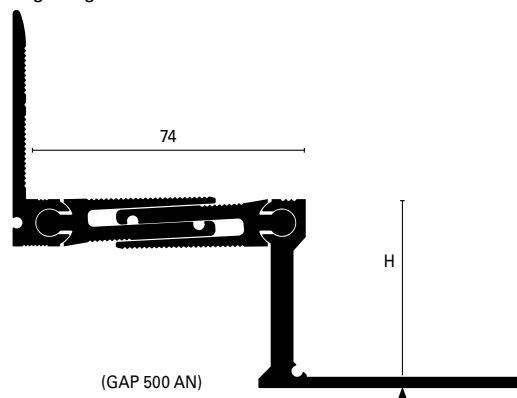

The horizontal sliding components allow the movement and avoid dust and dirt accumulation. Within the flooring bays frame created with the structural joints, a further surface subdivision with a suitable pattern of movement / expansion joints should be always provided for. See relevant indications on page 263

#### INSTALLATION:

- Assemble the joint inserting the two horizontal components within the two lateral flanges
- Align properly the expansion joint
- Fasten the lateral flanges into the substrate with suitable fixing plugs (7 each linear meter, i.e. one every 30 cm, proceeding parallel on the two sides).
- Lay then the screed over the structural joint flanges and tile as normal.

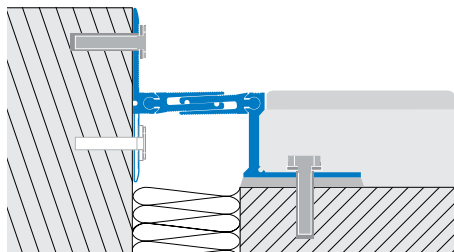

**JOINTEC GAP-AN Aluminium width 74 mm - gap 64 mm**  
Extruded aluminium profile. Good mechanical and chemical resistance over time. For outdoor utilization the similar joint type Jointec GM in brass is advisable. Installation between floor and wall.



	H=mm	L=mm	Art.		
Material: Aluminium extruded	20	74	GAP	200	AN
	50	74	GAP	500	AN
	70	74	GAP	700	AN
Finish: Natural (AN)					
Length: 4,00 metres					



# jointec™ GH

Structural joints entirely made of aluminium. Jointec GH is a joint suitable for truck and fork-lift high passage in civil and industrial use. Designed to bear structural movements of large sized buildings or compounds of buildings. To be installed on pre-existing surfaces, also vertically, over the spaces existing between two semi-detached parts of a building of smaller entity or between different beam bays. They can connect and close these interspaces adjusting themselves up-wards, downwards and even transversely, according to the shrinkage-settlement movements of the whole building, either cyclic or permanent. Within the bay frame created with the structural joints, a further surface subdivision with a suitable pattern of movement / expansion joints should be always provided for. Detailed mounting instructions can be supplied on request.

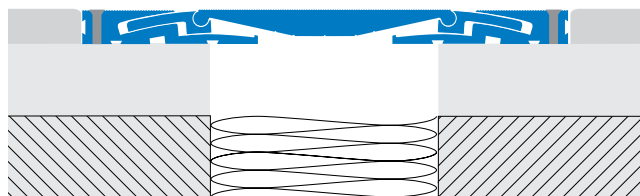
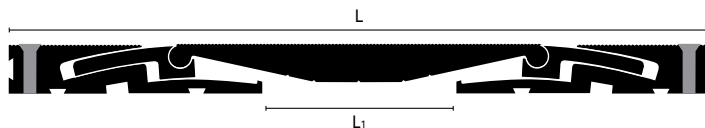

## JOINTEC GH-AN Aluminium natural height 20 mm

Extruded aluminium profile. Good mechanical and chemical resistance over time. For outdoor utilization the similar joint type Jointec GM in brass or stainless steel is advisable.



	L <sub>1</sub> =mm	L=mm	Finish	Art.		
Material: Aluminium extruded	100	305	Aluminium	GH	1000	AN
	150	360	Aluminium	GH	1500	AN
	200	410	Aluminium	GH	2000	AN
Finish: Natural (AN)						
Length: 3,00 metres						





**JOINTEC GW** waterproof structural expansion joint. The structure is manufactured with solid high carbon steel, anti-vibrating rubber, suitable for forklift passage, even small wheeled, stabilized rubber insert, waterproofing membrane to be hot joined flush and smooth to the waterproofing layer, with no tensions or shearing stress. In case of damage the insert can be replaced without ruining the additional waterproofing layer. Suitable for all types of flooring. Application areas: parkings and garages even underground, all industrial areas. Detailed mounting instructions can be supplied on request.

jointec™ GW

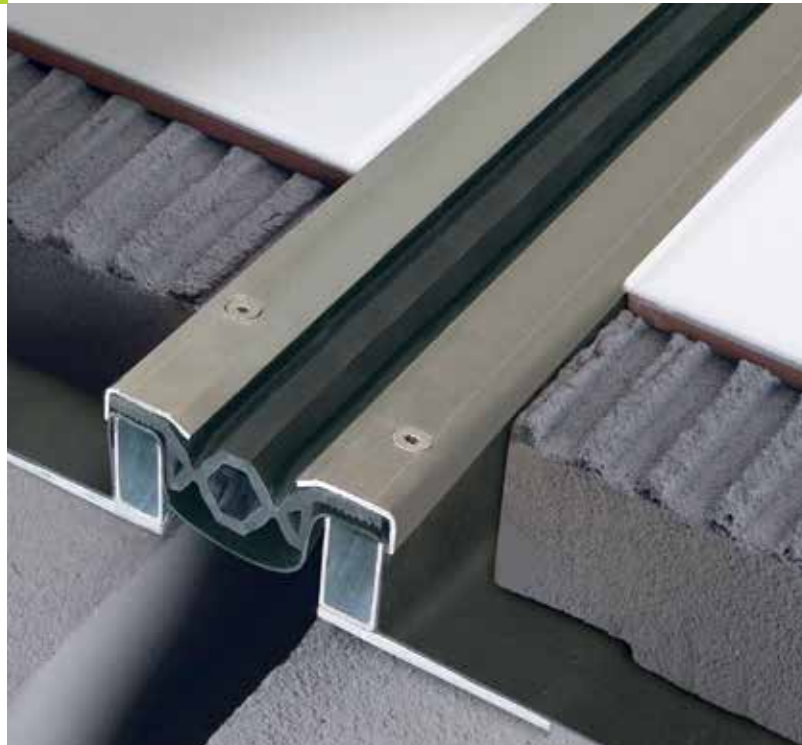
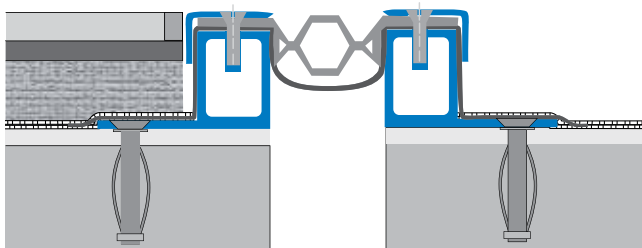
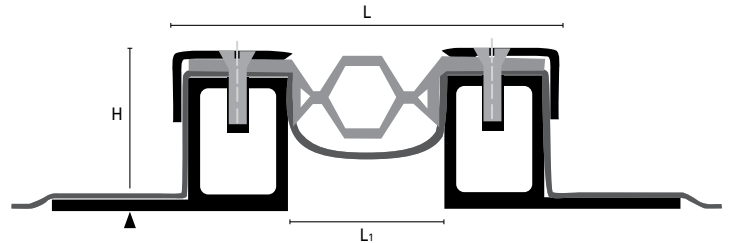

**JOINTEC GW-IN Stainless steel width 135 mm gap 80 mm**  
Profiles with solid steel structure covered by stainless steel AISI 304.



	H=mm	L1=mm	L=mm	Finish	Art.		
Material: Stainless steel	54	80	135	St. steel +Insert	GW	540	IN 51
	64	80	135	St. steel +Insert	GW	640	IN 51
	94	80	135	St. steel +Insert	GW	940	IN 51
Finish: Natural (IN)							
Insert: Resinprene + Waterproof membrane Wolfin							
Length: 3,00 metres							



jointec™ GS

Modular high width structural joints as provided by standards for seismic risk areas. The remarkable width to cover reduces their load resistance, they are nevertheless suitable for pedestrian and small trolleys passage, like stretchers or supermarket trolleys.

They are installed over the spaces existing between two semidetached parts of a building of smaller entity or between different beam bays. They can connect and close these inter-spaces adjusting themselves up-wards, downwards and even transversally, according to the shrinkage-settlement movements of the whole building, either cyclic or permanent.

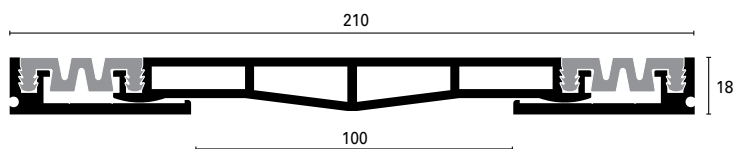

**INSTALLATION:**

- Slip the rubber infill into the metal insert before aligning the expansion joint in site.
- It is advisable to protect the rubber with some adhesive tape to avoid any cement spot.
- Fasten the insert into the substrate, through the holes under the rubber, the suitable fixing plugs (7 each linear meter, i.e. one every 30 cm proceeding parallel on the two sides).

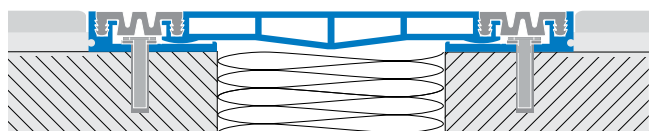

**JOINTEC GS 1000 AN\* Aluminium gap width 100 mm**

Extruded aluminium profile. Good mechanical and chemical resistance over time. Highly elastic double synthetic rubber insert of 37 mm.

Insert: standard version or smooth version available on request (pag. 179).



	H=mm	L=mm	L1=mm	Finish	Art.		
Material: Aluminium extruded	18	210	100	All. nat.	GS	1000	AN 51/23*
Finish: Natural (AN)							
Insert: Resinprene Black (P51 - suggested), Cement grey (P23)							
Length: 4,00 metres							

\*"S" for the smooth insert version



jointec™ P

The structural joints series JOINTEC GE, GM and GD are all transformable into wall-to-floor corner joints for perimeter applications. JOINTEC P is a multipurpose lateral anchorage aluminium profile, which can be used either upwards, to be fixed on the wall, or downwards, hidden in the perimeter floor joint.

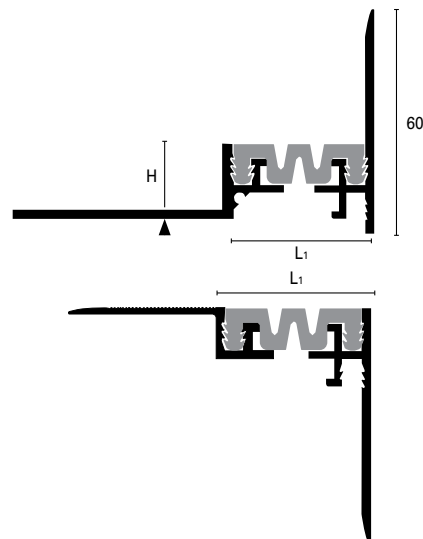

(GEP 200\* - GDP 400 AN\*)

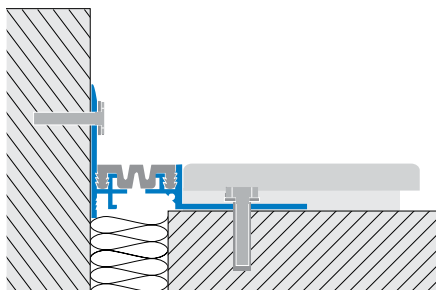

**JOINTEC GEP/GELP Aluminium gap width 40/50 mm**

Perimeter version of the structural joints series GE/GEL, with rubber insert in either 37 or 47 mm width.

Insert: standard version or smooth version available on request (pag. 179).



**JOINTEC GMP/GMLP Aluminium gap width 40/50 mm**

Perimeter version of the structural joints series GM/GML, with rubber insert in either 37 or 47 mm width.

Insert: standard version or smooth version available on request (pag. 179).



**JOINTEC GDP/GDLP Aluminium gap width 43/53 mm**

Perimeter version of the structural joint series GD/GDL, with rubber insert in either 37 to 47 mm width.

Insert: standard version or smooth version available on request (pag. 179).



	H=mm	L1=mm	Art.		
Material: Aluminium extruded	20	40	GEP	200	AN 51/23*
	50	40	GEP	500	AN 51/23*
Finish: Natural (AN)	20	50	GELP	200	AN 51/23*
	50	50	GELP	500	AN 51/23*
Insert: Resinprene					
Black (P51 - suggested),					
Cement grey (P23)					
Length: 4,00 metres					

\*\*S" for the smooth insert version

Material: Aluminium extruded	35	40	GMP	350	AN 51/23*
	50	40	GMP	500	AN 51/23*
Finish: Natural (AN)	75	40	GMP	750	AN 51/23*
Insert: Resinprene	35	50	GMLP	350	AN 51/23*
Black (P51 - suggested),	50	50	GMLP	500	AN 51/23*
Cement grey (P23)	75	50	GMLP	700	AN 51/23*
Length: 3,00 metres					

\*\*S" for the smooth insert version

Material: Aluminium extruded	12	43	GDP	400	AN 51/23*
	12	53	GDLP	500	AN 51/23
Finish: Natural (AN)					
Insert: Resinprene					
Black (P51 - suggested),					
Cement grey (P23)					
Length: 4,00 metres					

\*\*S" for the smooth insert version



jointec™ GD

Aluminium body structural expansion joint with synthetic rubber insert. Designed to bear structural movements of large sized buildings or compounds of buildings. To be installed on pre-existing surfaces, also vertically, over the spaces existing between two semi-detached parts of a building of smaller entity or between different beam bays. They can connect and close these inter-spaces adjusting themselves up-wards, downwards and even transversely, according to the shrinkage-settlement movements of the whole building, either cyclic or permanent.

Within the bay frame created with the structural joints, a further surface subdivision with a suitable pattern of movement / expansion joints should be always provided for.

See relevant indications on page 263.



(GD 400 AN\*)

**INSTALLATION:**

- Slip the rubber infill into the metal insert before aligning the expansion joint in site.
- It is advisable to protect the rubber with some adhesive tape to avoid any cement spot.
- Fasten the lateral flanges by utilizing:
  - a) Screws and dowels (1 every 18 cm proceeding parallel along the two sides).
  - b) With a Bi-component epoxy adhesive glue.

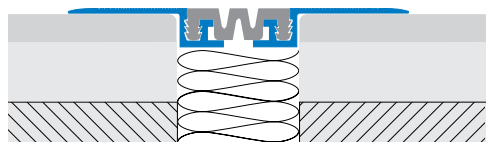

**JOINTEC GD 400 AN\* Aluminium gap width 40 mm**

Extruded aluminium profile. Good resistance to chemical agents and mechanical impacts over time. Highly elastic 37 mm wide synthetic rubber insert.

Insert: standard version or smooth version available on request (pag. 179).



	H=mm	L=mm	L1=mm	Finish	Art.		
Material: Aluminium extruded	12	37	40	Al+ins.	GD	400	AN 51/23*
Finish: Natural (AN)							
Insert: Resinprene Black (P51 - suggested), Cement grey (P23)							
Length: 4,00 metres							

\*"S" for the smooth insert version

**JOINTEC GDL 500 AN\* Aluminium gap width 50 mm**

Extruded aluminium profile. Good resistance to chemical agents and mechanical impacts over time. Highly elastic 47 mm wide synthetic rubber insert.



	H=mm	L=mm	L1=mm	Finish	Art.		
Material: Aluminium extruded	12	47	50	Al+ins.	GDL	500	AN 51/23
Finish: Natural (AN)							
Insert: Resinprene Black (P51 - suggested), Cement grey (P23)							
Length: 4,00 metres							





# jointtec™ GDM

Aluminium body structural expansion joint with synthetic rubber insert. Designed to bear structural movements of large sized buildings or compounds of buildings. To be installed on pre-existing surfaces, also vertically, over the spaces existing between two semi-detached parts of a building of smaller entity or between different beam bays. They can connect and close these interspaces adjusting themselves up-wards, downwards and even transversely, according to the shrinkage-settlement movements of the whole building, either cyclic or permanent.

Within the bay frame created with the structural joints, a further surface subdivision with a suitable pattern of movement / expansion joints should be always provided for.

See relevant indications on page 263.

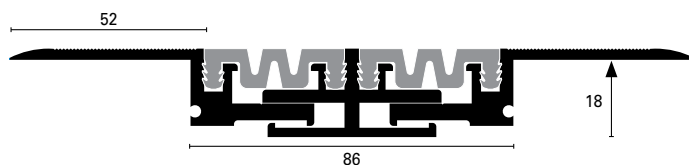

## INSTALLATION:

- Slip the rubber infill into the metal insert before aligning the expansion joint in site.
- It is advisable to protect the rubber with some adhesive tape to avoid any cement spot.
- Fasten the lateral flanges by utilizing:
  - a) screws and dowels (1 every 18 cm proceeding parallel along the two sides).
  - b) with a Bi-component epoxy adhesive glue.

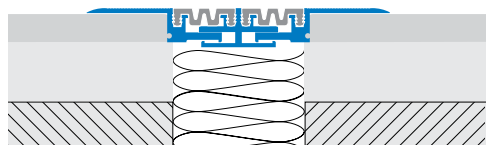

## JOINTEC GDM 860 AN\* Aluminium gap width 86 mm

Extruded aluminium profile. Good resistance to chemical agents and mechanical impacts over time. Highly elastic 37 mm wide synthetic rubber insert.

Insert: standard version or smooth version available on request (pag. 179).



	H=mm	L=mm	Finish	Art.		
Material: Aluminium extruded	18	86	Alum.+ black ins.	GDM	860	AN 51*
	18	86	Alum.+ grey ins.	GDM	860	AN 23*
Finish: Natural (AN)						
Insert: Resinprene Black (P51 - suggested), Cement grey (P23)						
Length: 4,00 metres						

\*"S" for the smooth insert version



Aluminium body structural expansion joint with synthetic rubber insert. Designed to bear structural movements of large sized buildings or compounds of buildings. To be installed on pre-existing surfaces, also vertically, over the spaces existing between two semi-detached parts of a building of smaller entity .They can connect and close these interspaces adjusting themselves up-wards, downwards and even transversely, according to the shrinkage-settlement movements of the whole building, either cyclic or permanent.

See relevant indications on page 263.

# jointec™ GAD

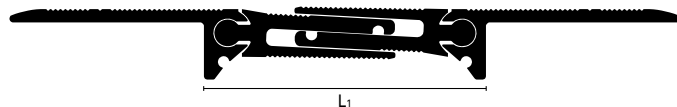

Illustrated scale dimension 1:2  
(GAD 700 AN)

### INSTALLATION:

- Fasten the lateral flanges by utilizing:
  - a) screws and dowels (1 every 18 cm proceeding parallel along the two sides).
  - b) with a Bi-component epoxy adhesive glue.

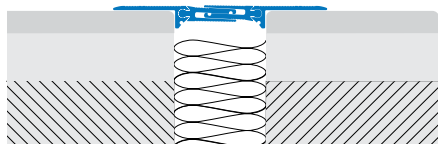

### JOINTEC GAD\* AN Aluminium gap width 75-105 mm

Extruded aluminium profile. Good resistance to chemical agents and mechanical impacts over time.

GAD700



GALD1000



	H=mm	L1=mm	Art.		
Material: Aluminium extruded	15 15	75 105	GAD GALD	700 1000	AN AN
Finish: Natural (AN)					
Length: 4,00 metres					



# jointtec™ GADP

Aluminium body structural expansion joint with synthetic rubber insert. Designed to bear structural movements of large sized buildings or compounds of buildings. To be installed on pre-existing surfaces, also vertically, over the spaces existing between two semi-detached parts of a building of smaller entity. They can connect and close these interspaces adjusting themselves up-wards, downwards and even transversely, according to the shrinkage-settlement movements of the whole building, either cyclic or permanent.

See relevant indications on page 263.

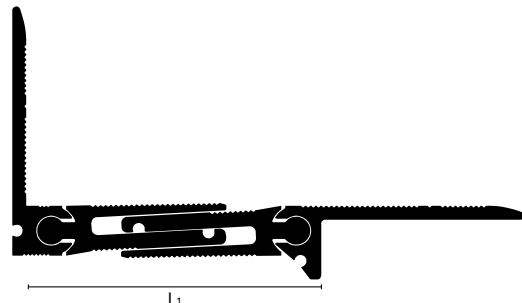

Illustrated scale dimension 1:2  
(GADP 700 AN)

### INSTALLATION:

- Fasten the lateral flanges by utilizing:
  - a) screws and dowels (1 every 18 cm proceeding parallel along the two sides).
  - b) with a Bi-component epoxy adhesive glue.

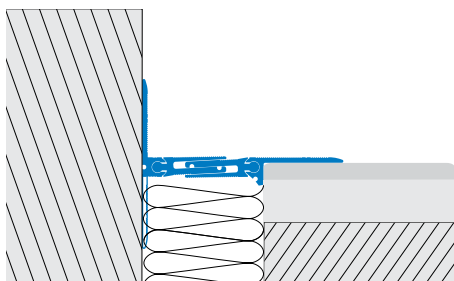

### JOINTEC GADP\* AN Aluminium gap width 78-110 mm

Extruded aluminium profile. Good resistance to chemical agents and mechanical impacts over time.

GADP700



GALDP1000



	H=mm	L1=mm	Art.		
Material: Aluminium extruded	15 15	78 110	GADP GALDP	700 1000	AN AN
Finish: Natural (AN)					
Length: 4,00 metres					



**copritec™ CPM**

**INSTALLATION:**

- Place the custom-made profile plate within the fixing modules leaving the necessary space for dilatation.
- Fix the lateral profiles at the required width, as per reported drawing, with screws and dowels or using a suitable adhesive.
- It is advisable to put a small quantity of silicone in the fixing modules before inserting the plate.

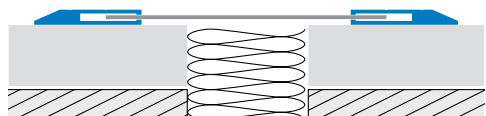

**COPRITEC CPM 450 AS Aluminium anodized silver**

Silver anodised aluminium fixing strips designed to hold the system firmly to the substrate while allowing movement in the cover plate.

**COPRITEC CPM\* AS Insert in aluminium anodized silver**

The cover plate is custom-made to customer requirements.

To calculate the size of the cover plate allow 8 mm of expansion within each of the fixing strips (CPM 450 AS) and consider the dimension of 32 mm specified in the drawing as starting "0" point.

The cover plate can be supplied flat (B dimension only) or as an "L" shape (A & B dimensions required).

Modular expansion joint covers, patented custom-made according to the required widths. Particularly suitable as expansion joint covers for walls or ceilings, supplied both in the flat and in the corner version. This profile consists of two lateral elements which work both as fixing system, with screws and dowels, and as restraining and movement devices for the aluminium profile, which is custom-made according to the required width. Supplied in Silver anodised aluminium.

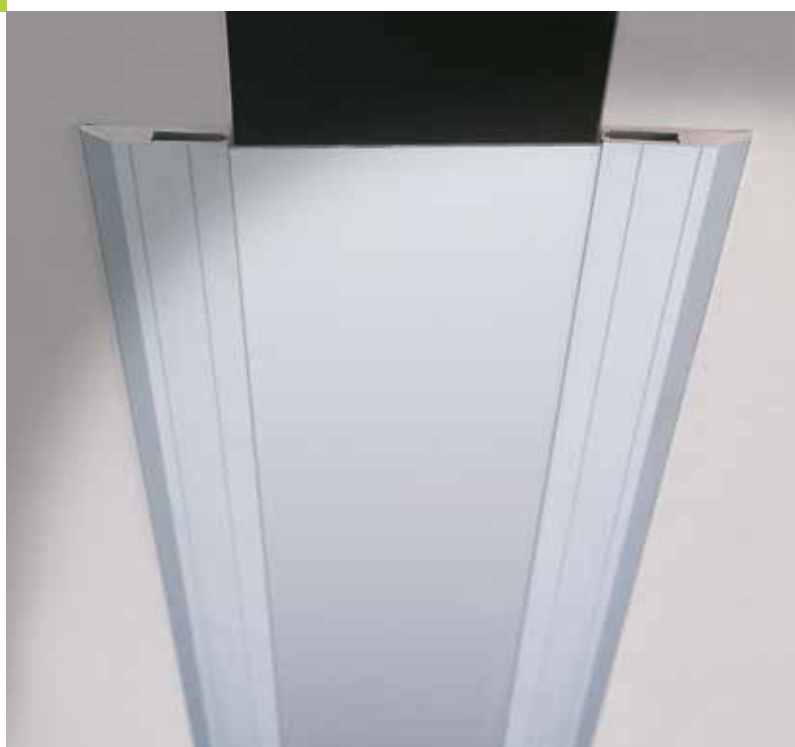
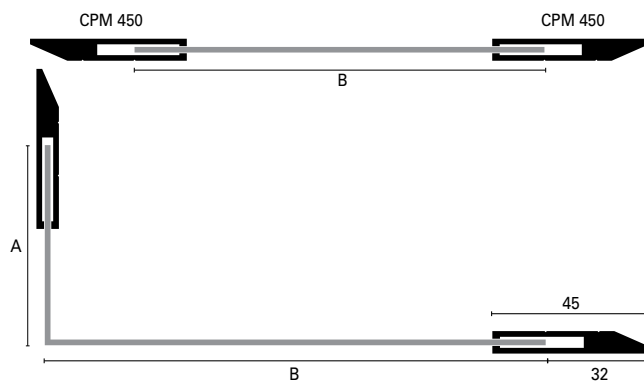

	<b>B=mm</b>	<b>Finish</b>	<b>Art.</b>		
Material: Extruded Anodised aluminium	45	Aluminium Silver	CPM	450	AS
Finish: Silver (AS)					
Length: 2,70 metres					

	<b>mm</b>	<b>Finish</b>	<b>Art.</b>	
Material: Aluminium laminate anodized	B AxB	Aluminium Silver Flat Aluminium Silver Corner	CPML CPMP	AS AS
Finish: Silver (AS)				
Length: 2,70 metres				





**copritec™ CP**

In industrial and commercial flooring, in the large continuous beam bays, and wherever two different bearing structures are linked together, a separation joint cover is often required, to allow linear expansion movements of neighbouring materials. This profile is supplied self-adhesive, with a special adhesive glue which ensures remarkable movements absorption. For screw-and-dowel installation it is advisable to fix the profile to one of the two structures drilling it along the length only on one side, leaving the other side free for the slip and expansion movements. This profile is also suitable for bumper guards for stretchers in hospitals or as wall protection in schools and offices.

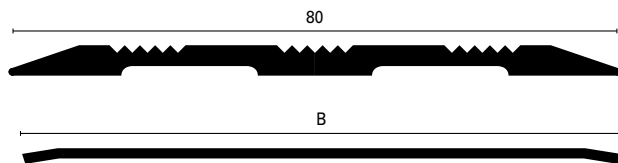

(CP 80\*)

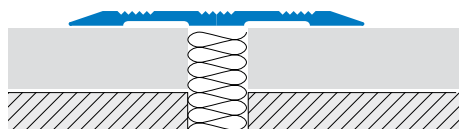

**COPRITEC CP 80 AS\* Aluminium anodized silver**

Anodised aluminium profile, silver finish. Good resistance against oxidation and mechanical impacts.

Version: Adhesive (ASA), Non-adhesive (ASN)

	B=mm	Art.		
Material: Extruded anodised aluminium	80	CP	80	ASA/ASN
Finish: Silver (AS)				
Length: 2,70 metres				

**COPRITEC CP-IL\* Polished stainless steel AISI 430**

Stainless steel polished profile, 1,2 mm thickness. Polished surface covered by a protective film. Good resistance to atmospheric agents and high mechanical resistance.

Version: Adhesive (ILA), Not adhesive (ILN)

Material: Stainless steel	60	CP	60	ILA/ILN
	80	CP	80	ILA/ILN
Finish: Polished (IL)	100	CP	100	ILA/ILN
Length: 2,70 metres				

**COPRITEC CP-OL\* Polished brass**

A laminated brass profile, 1,2 mm thickness. It ensures a high tolerance to mechanical impact and corrosion.

Version: Adhesive (OLA), Not adhesive (OLN)

Material: Brass laminate	60	CP	60	OLA/OLN
	80	CP	80	OLA/OLN
Finish: Polished (OL)	100	CP	100	OLA/OLN
Length: 2,70 metres				



joint<sup>+</sup>tec™ GC

PVC joint patented conceived to create a "grid" at floor level for cement industrial paving, made through forming and smoothing with the vibrating float.

First fit joints at the required height in bays of generally 5 x 5 metres. Proceed then casting concrete and forming it leaning directly on the joint which will work as level line. It will not be necessary to make subsequent saw cuts and filling in the floors, thus completing the job properly at one go.

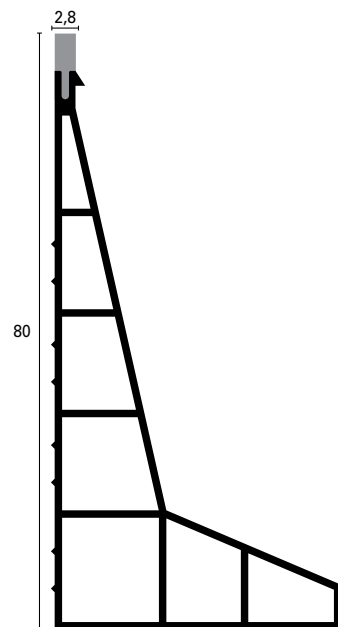

The application drawing here below shows how the joint controls the movement zones and possible fissuring points. Quick assembly, performing and long lasting, time saving with a perfect result.

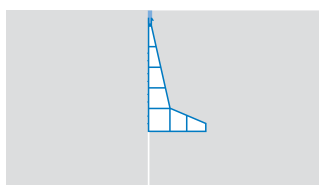

**JOINTEC GC 80 P23 Co-Extruded synthetic resin**

Base module in co-extruded synthetic resin, rigorously controlled during production.

	H=mm	Art.		
Material: PVC	80	GC	80	P23
Colour: Cement grey (P23)				
Length: 2,50 metres, on request 5,00 mt				



Along the perimeter there must necessarily be a sufficient dilatation space. Using the joint GC, plus the soft profile GCP you will get at one go both the required level on which to place the shafts, the necessary dilatation and a nice finish of the perimeter, avoiding need of further skirting.

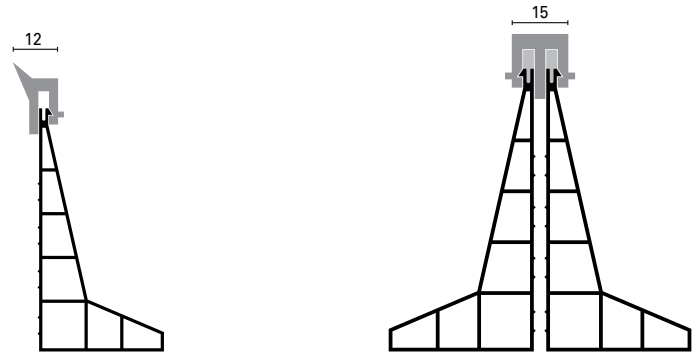

Thanks to its modularity, the joints GC can be coupled and mounted with the suitable PVC profile GCR, thus obtaining a double-performing control joint, with high absorption and movement qualities, as required for example in correspondence of slab casting discontinued placements.

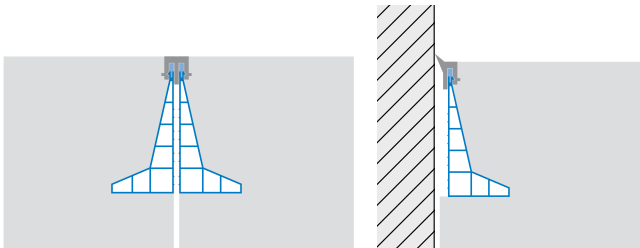

**JOINTEC GCP 80 P23 Synthetic resin resinflex**

Profile to match with the base modul GC to form a surface perimeter joint which can replace traditional skirtings.

**JOINTEC GCR 80 P23 Synthetic resin resinflex**

Profile to mount with two base moduls GC placed back-to-back, creating a joint for breaks in the screeding.

	B=mm	Art.		
Material: Resinflex	12	GCP	80	P23
Colour: Cement grey (P23)				
Length: in roll L= 100 mt				

	B=mm	Art.		
Material: Resinflex	15	GCR	80	P23
Colour: Cement grey (P23)				
Length: in roll L= 100 mt				



Joint filler for saw cuts in concrete and quartz-paste industrial floors, smoothed with vibrating float.

Once casting has been completed, the floor is saw cut normally in 5m x 5m bays, to control the movements and ensure proper dilatation space. Thanks to the exclusive production system with an inner glass fibre thread, this joint does not elongate during installation and limits the shrinkage, as it normally happens with profiles without glass fibre, at the rate of 5/10 cm already after a few days after installation.

The particular lightened shape in the upper part improves the profile versatility, which can suit cuts widths from 3,5 to 5,5 mm.

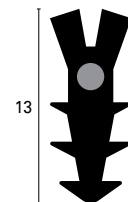

jointec™ GT



**JOINTEC GT 35/55 P51 Synthetic Resin Resinflex**

Joint seal for no-site cuts in industrial floors in soft PVC with anti-elongation glass fibre.

	L=mm	Art.		
Material: Resinflex	3,5-5,5	GT	35/55	P51
Colour: Black (P51)				
Length: in roll Long= 200 mt				





The structural expansion joints series Jointec are available in the version with "standard" or ribbed Resinprene insert (for width 37 mm). Resinprene is a special vulcanized rubber EPDM and Neoprene based, with excellent mechanical performance in an operating temperature interval of -40°C to +150°C. Low permanent deformation to compression and tensile stress. Excellent resistance to ageing.

# jointec™ GI-GIL

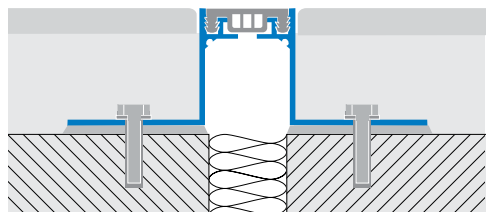
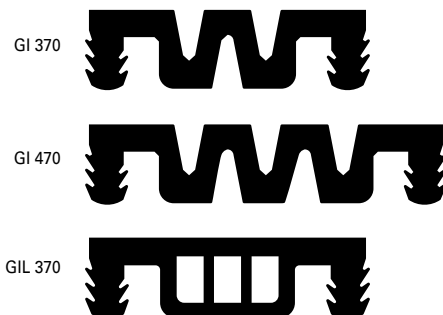

**JOINTEC GI 370 P\* Insert in Resinprene standard width 37 mm**  
Insert in grey and black version which can be used in all the Jointec series of structural joints.

	L=mm		Art.	
Material: Resinprene	37	GI	370	P51/23
Colour: Black (P51), Cement grey (P23)				
Length: roll 40 mt				

**JOINTEC GI 470 P\* Insert in Resinprene standard width 47 mm**  
Insert in grey and black version which can be used in all the Jointec series of structural joints.

Material: Resinprene	47	GI	470	P51/23
Colour: Black (P51), Cement grey (P23)				
Length: roll 40 mt				

**JOINTEC GIL 370 P\* Insert in Smooth Resinprene width 37 mm**  
Insert in grey and black version which can be used in all the Jointec series of structural joints.

Material: Resinprene	37	GIL	370	P51/23
Colour: Black (P51), Cement grey (P23)				
Length: roll 40 mt				

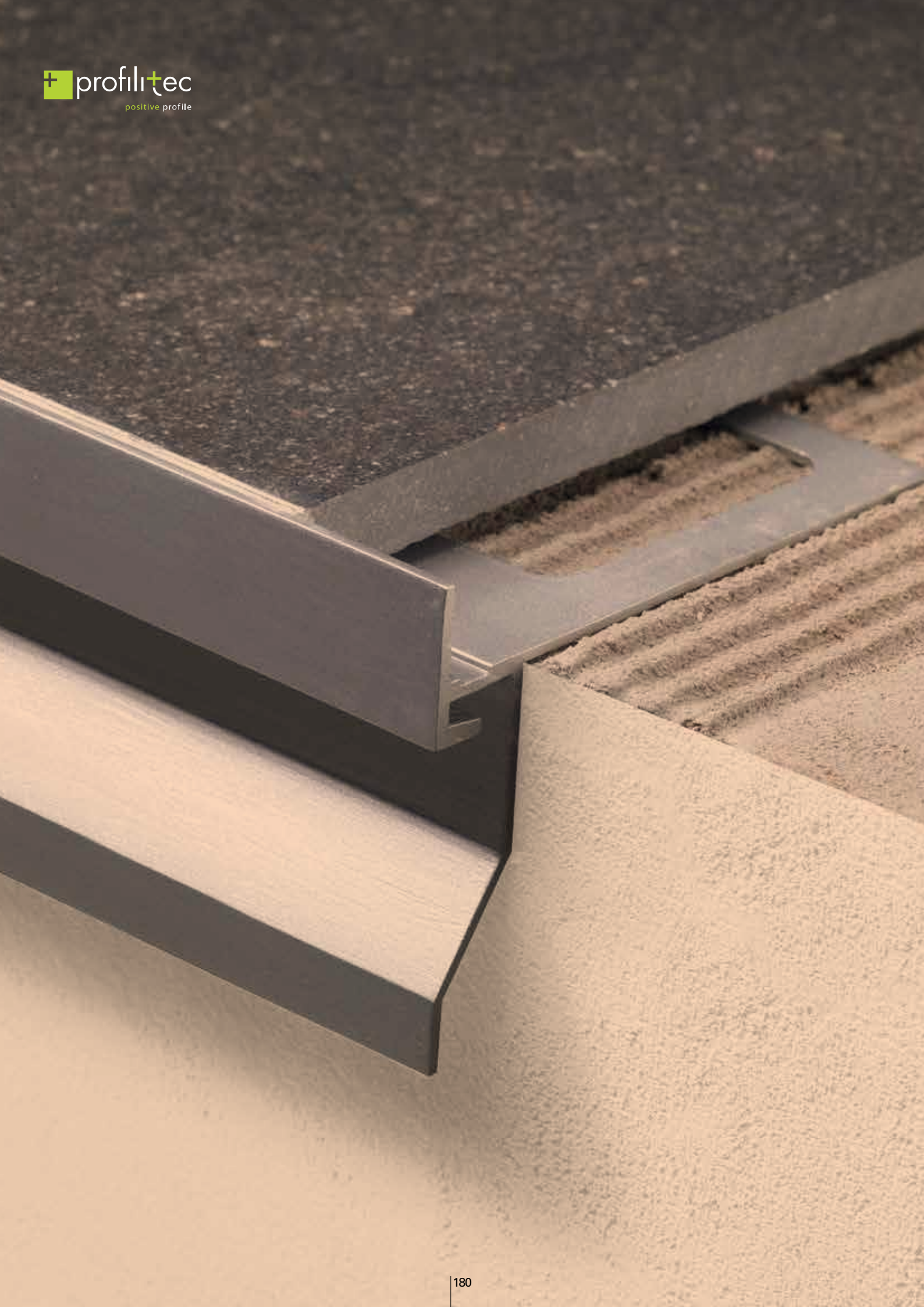



## Perimeter profiles for balconies

A complete range of perimeter multi-purpose profiles for balconies and terraces in powder coated aluminium in 7 colours and in stainless steel, conceived as an alternative to the common threshold covers in marble and the L-elements in ceramic.

Finishing profiles, junctions and framing elements for terrace edges.

Innovating systems for terraces and/or floating floors.

Article		Use	Page
Bordertec	BD	draining screed	182
Bordertec	BBS	balconies	183
Bordertec	BCO	draining profile	184
Bordertec	BO	perimeter	185
Bordertec	BOS	perimeter	186
Bordertec	BR	perimeter	187
Bordertec	BTR	modular	188
Copridrain	PD	drain well	189
Bordertec	BSR	edge	190
Skirting	BIM	skirting	191
Support	SUPF	fixed support	192
Support	SUPA	adjustable support	194
Trimtec	SR	edge profiles	196

05\_





Multipurpose perimeter profile for edge finishing of balconies and terraces to allow drainage and to facilitate screeding to the required thickness. BORDERTEC BD is available in two formats: with drainage holes (for use with DRAINTEC 8 matting) or without holes (to provide an edge profile for use with waterproofing compounds). Tiles can be laid flush with the profile or can sit proud.

The profile is also suitable for dry tiling on gravel substrates. Leave the necessary space between the different elements for the thermic expansion.

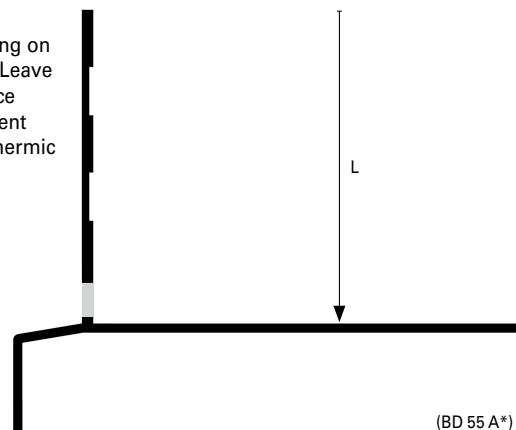

(BD 55 A\*)

## border+tec™ BD

### INSTALLATION INSTRUCTIONS:

- Fix the profile along the perimeter on each side where needed, positioning it at the required height.
- Cast the screed bed within the framing created by the finishing profile.
- Tile as normal.

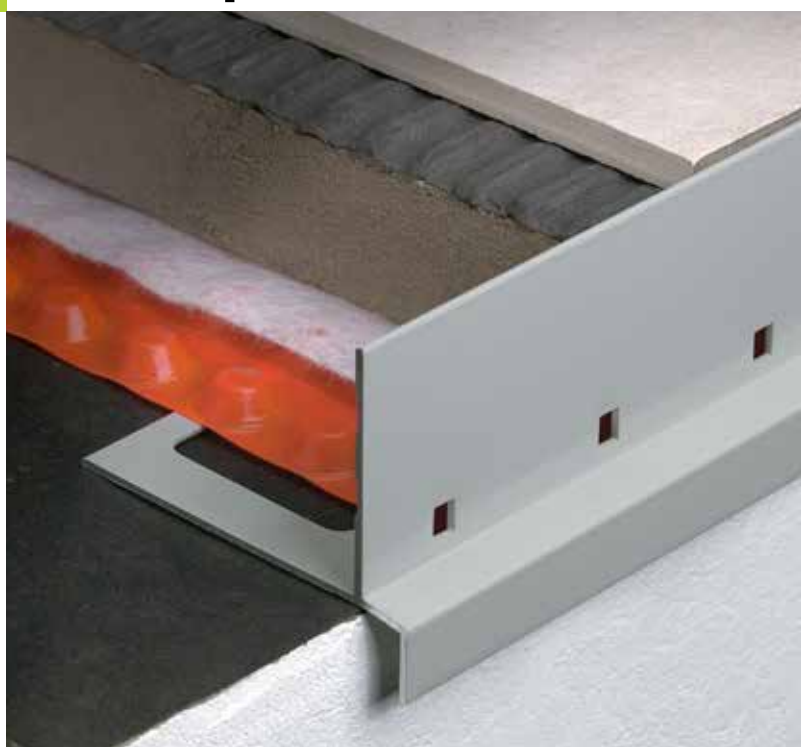
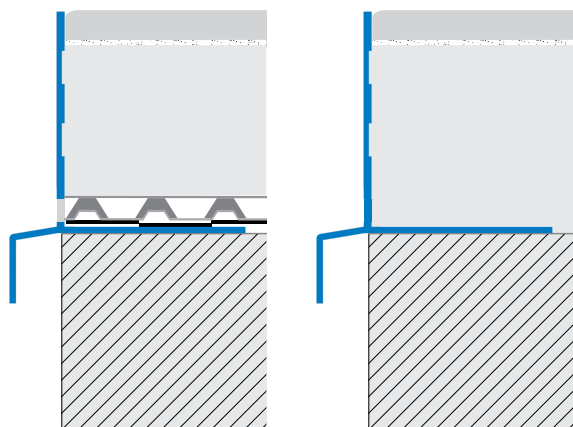

### BORDERTEC BD-A\* Powder coated aluminium with drainage holes

Version with drainage holes to ensure water run-off at DRAINTEC 8 drainage matting level.

Profile coated on its entire surface with polyester powder.

External connection pieces: cod. BDE-A\*

Joining pieces: cod. BDG-A\*

### BORDERTEC BDC-A\* Powder coated aluminium without drainage holes

Version without drainage holes on the external side, with restraining and water drip purposes.

Profile coated on its entire surface with polyester powder.

External connection pieces: cod. BDCE-A\*

Joining pieces: cod. BDG-A\*

	L=55mm			L=75mm			Finish
Material:	BD	55	A11	BD	75	A11	11= Pure white
Powder Coated Aluminium	BD	55	A22	BD	75	A22	22= Grey
	BD	55	A32	BD	75	A32	32= Dark Beige
Length: 2,70 metres	BD	55	A62	BD	75	A62	62 = Red Brown
External connection pieces:	BD	55	A63	BD	75	A63	63 = Dark Brown
Cod. BDE-A*							
Joining pieces:							
Cod. BDG-A*							

	L=55mm			L=75mm			Finish
Material:	BDC	55	A11	BDC	75	A11	11= Pure white
Powder Coated Aluminium	BDC	55	A22	BDC	75	A22	22= Grey
	BDC	55	A32	BDC	75	A32	32= Dark Beige
Length: 2,70 metres	BDC	55	A62	BDC	75	A62	62 = Red Brown
External connection pieces:	BDC	55	A63	BDC	75	A63	63 = Dark Brown
Cod. BDCE-A*							
Joining pieces:							
Cod. BDG-A*							





# border+tec™ BBS

Perimeter profile for the finishing and protection of the external cement borders with an upper edging trim designed to frame also the tiled surface where it is laid flush with the screed.

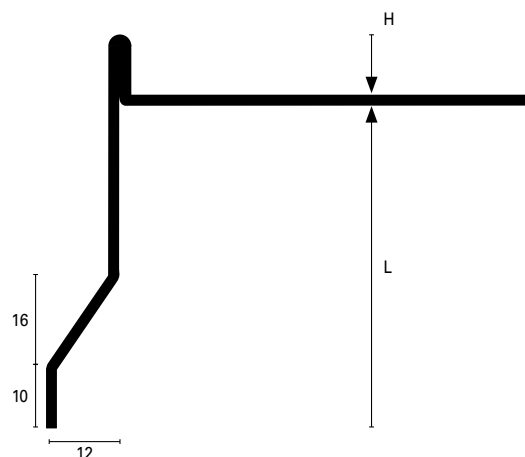

(BBS 55 A\*)

The system visible part is curved so as to “bell cast” serving as a water drip element and also protecting DRAINTEC 8 membrane laid under the screed and over the waterproofing layer. Leave the necessary space between the different elements for the thermic expansion covering the gap with the joining pieces.

### INSTALLATION INSTRUCTIONS:

- Choose the profile height correspondent to tile thickness and suitable for the screed depth.
- Position it along the edge of the surface to tile and install it while tiling.

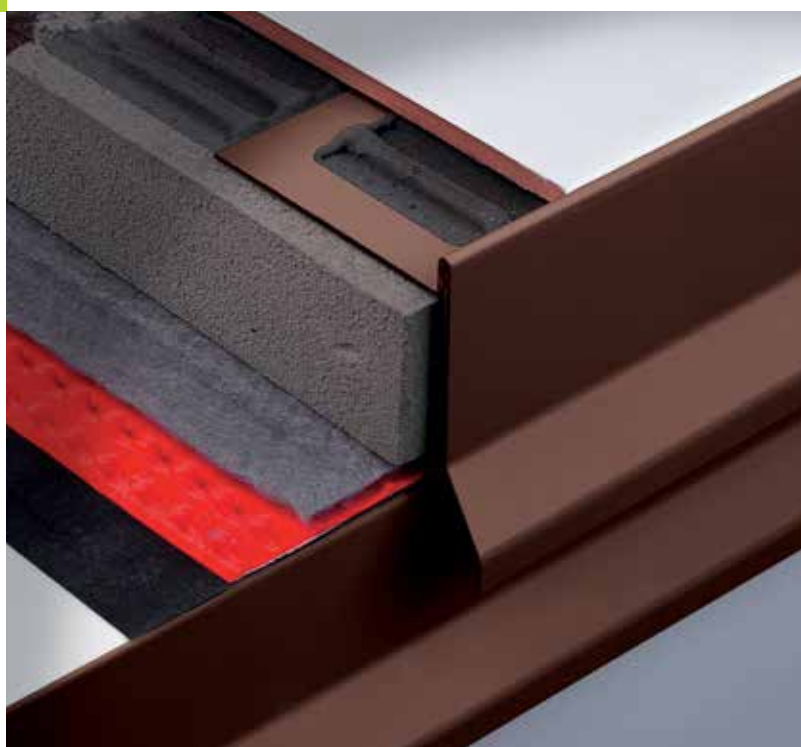
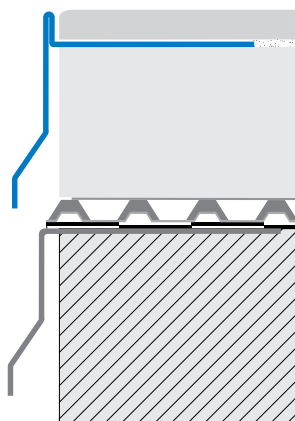

### BORDERTEC BBS-A\* / BCS-A\* Powder Coated Aluminium

**BBS: H=10mm, BCS: H=12,5mm**

Profile coated on its entire surface with polyester powder.

Internal corner piece: Code BBSI-A\*

External connection pieces: cod. BBSE / BCSE-A\*

Joining pieces: cod. BBSG / BCSG-A\*

\*\* (on request)

### BORDERTEC BBS-IL / BCS-IL Stainless Steel Polished AISI 304 - DIN 1.4301

**BBS: H=10mm, BCS: H=12,5mm**

Polished Stainless Steel AISI 304 ensures high resistance to corrosion.

External connection pieces: cod. BBSE / BCSE-IL

Joining pieces: cod. BBSG / BCSG-IL

	H=mm	L=mm	Art.	Art.	Finish
Material: Powder Coated Aluminium	10	42	BBS	42	A11/A22/A32/A50 A60/A62/A63
Finish*: Pure white (11), Grey (22), Dark beige (32), Red Brown (62), Dark Brown (63), Micaceous grey (50), Corten (60)	10	55	BBS	55	A11/A22/A32/A50 A60/A62/A63
	10	75	BBS	75	A11/A22/A32/A50** A60**/A62/A63
	10	95	BBS	95	A11/A22/A32/A50** A60**/A62/A63
Length: 2,70 metres	12,5	42	BCS	42	A11/A22/A32/A50** A60**/A62/A63
Int. corner piece: Code BBSI-A* (solo L=42/55 m A11/A22/A50)	12,5	55	BCS	55	A11/A22/A32/A50** A60**/A62/A63
External connection pieces: Cod. BBSE / BCSE-A*	12,5	75	BCS	75	A11/A22/A32/A50** A60**/A62/A63
Joining pieces: Cod. BBSG / BCSG-A*	12,5	95	BCS	95	A11/A22/A32/A50** A60**/A62/A63
Material: Stainless Steel AISI 304	10	42	BBS	42	IL
	10	55	BBS	55	IL
	10	75	BBS	75	IL
Finish: Polished (IL)	10	95	BBS	95	IL
	12,5	42	BCS	42	IL
	12,5	55	BCS	55	IL
External connection pieces: Cod. BBSE / BCSE-IL	12,5	75	BCS	75	IL
Joining pieces: Cod. BBSG / BCSG-IL	12,5	95	BCS	95	IL



**Borderotec BCO** is a perimeter finishing profile for the protection of the exposed cement screed in balconies and terraces. The upper finishing tooth works also as restrainer of the tiled covering.

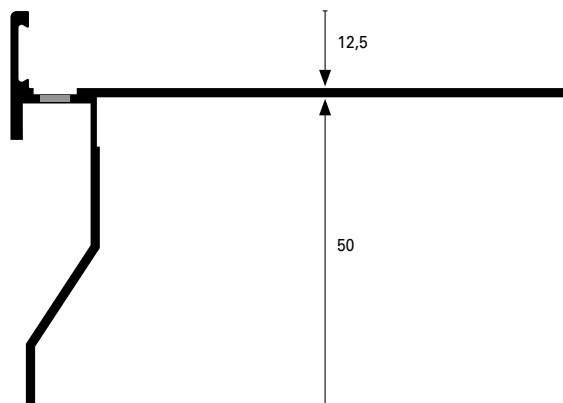

(BCO 50 A\*)

## border+tec™ BBO-BCO

The profile optimized section is provided with drain holes underneath, conceived to facilitate water and humidity run-off. During the installation it is important to leave the necessary space for thermal dilatation, hiding the joint with the junction piece.

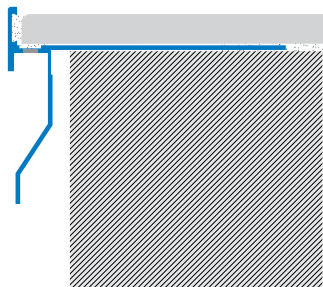

### BORDERTEC BBO-A\* / BCO-A\* Powder Coated Aluminium

**BBO: H=10mm, BCO: H=12,5mm**

Profile coated on its entire surface with polyester powder.

External connection pieces: cod. BBOE-A\* / BCOE-A\*

Joining pieces: cod. BBOG-A\* / BCOG-A\*

	H=mm	L=mm	Art.		Finish
Material:	10	50	BBO	50	A22/A50
Powder Coated Aluminium	12,5	50	BCO	50	A22/A32/A50/A63
Finish*: Grey (A22), Dark Beige (A32), Micaceous grey (A50), Dark Brown (A63)					
Length: 2,70 metres					
External connection pieces: cod. BBOE-A* / BCOE-A*					
Joining pieces: cod. BBOG-A* / BCOG-A*					



# border+tec™ BO

## LAYING INSTRUCTIONS:

- Choose the profile suitable for screed bed depth
- Position it along the edge of the surface to be tiled and install it while tiling.



Example of external connection plus joining piece

### BORDERTEC BO-A\* Powder Coated Aluminium

Profile coated on its entire surface with polyester powder.

External connection pieces: Cod. BOE-A\*

Joining pieces: Cod. BOG-A\*

### BORDERTEC BO-IL Stainless Steel Polished AISI 304 - DIN 1.4301

Stainless Steel Polished AISI 304 ensures high resistance to corrosion.

External connection pieces: Cod. BOE-IL

Joining pieces: Cod. BOG-IL

“L” shaped perimeter edge profile for the finishing and protection of the external cement borders. Designed for tile edges protruding over screed base. Leave the necessary space between the different elements for the thermic expansion covering the gap with the joining pieces.

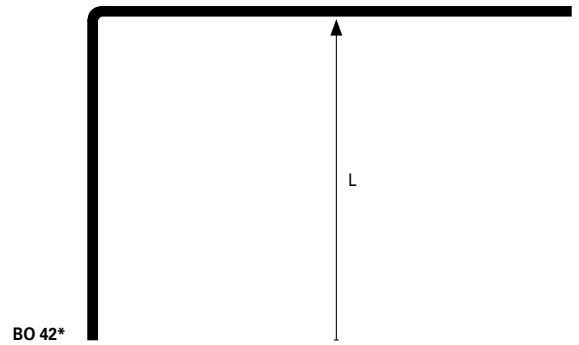

	L=mm	Art.		Finish
Material:	30	BO	30	A11/A22/A32/A62/A63
Powder Coated Aluminium	42	BO	42	A11/A22/A32/A62/A63
	55	BO	55	A11/A22/A32/A62/A63
Finish*: Pure white (11),	75	BO	75	A11/A22/A32/A62/A63
Grey (22),	95	BO	95	A11/A22/A32/A62/A63
Dark beige (32),				
Red Brown (62),				
Dark Brown (63)				
Length: 2,70 metres				
External connection pieces:				
Cod. BOE-A*				
Joining pieces: cod. BOG-A*				

Material:	30	BO	30	IL
Stainless Steel AISI 304	42	BO	42	IL
	55	BO	55	IL
Finish: Polished(IL)	75	BO	75	IL
	95	BO	95	IL
Length: 2,70 metres				
External connection pieces: Cod.				
BOE-IL				
Joining pieces: cod. BOG-IL				



# border+tec™ BOS

Perimeter profile for the finishing and protection of the external cement borders designed for tile edges protruding over screed base. The system visible part is curved so to "bell cast" serving as a water drip element and also protecting DRAINTEC 8 membrane laid under the screed and over the waterproofing layer. Leave the necessary space between the different elements for the thermic expansion covering the gap with the joining pieces.

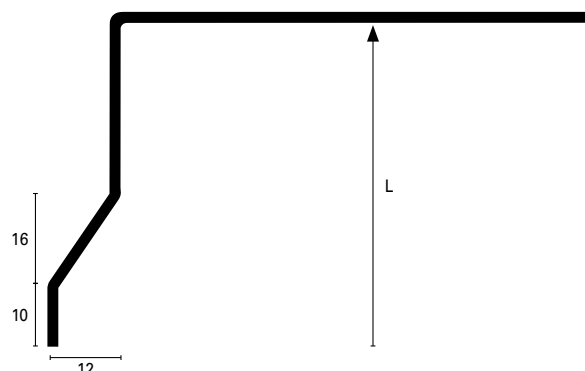

(BOS 42\*)

## INSTALLATION INSTRUCTIONS:

- Choose the profile suitable for screed bed depth.
- Position it along the edge of the surface to be tiled and install it while tiling.

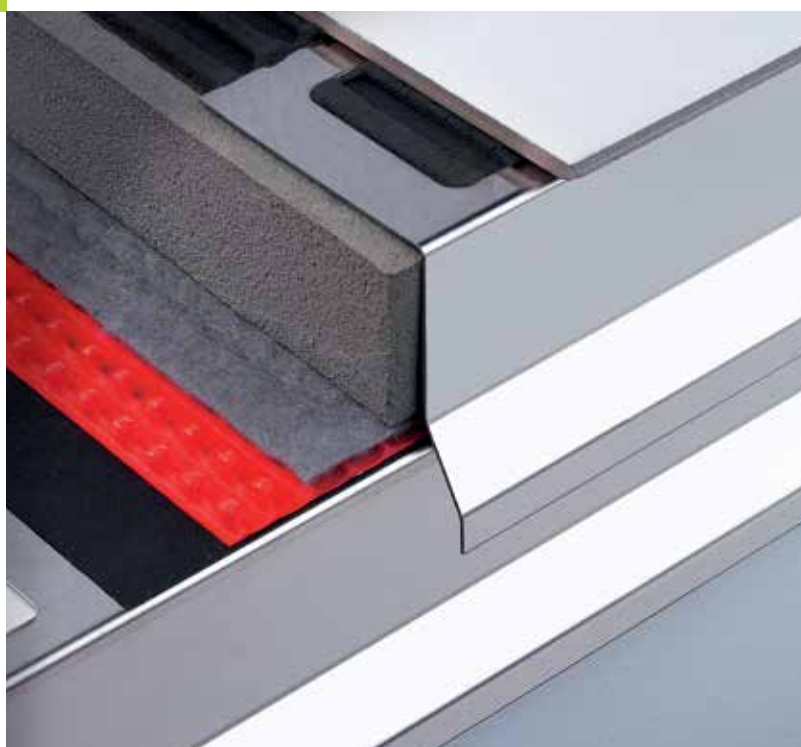
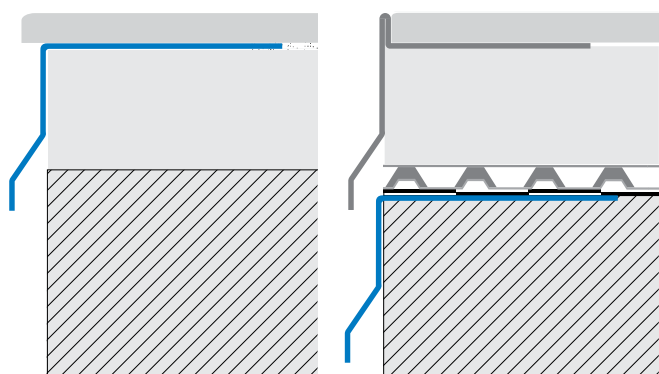

## BORDERTEC BOS-A\* Powder Coated Aluminium

Profile coated on its entire surface with polyester powder.

External connection pieces: Cod. BOSE-A\*

Joining pieces: Cod. BOSG-A\*

	L=mm	Art.		Finish
Material:	42	BOS	42	A11/A22/A32/A62/A63
Powder Coated Aluminium	55	BOS	55	A11/A22/A32/A62/A63
Finish*: Pure white (11), Grey (22), Dark beige (32), Red Brown (62), Dark Brown (63)	75	BOS	75	A11/A22/A32/A62/A63
	95	BOS	95	A11/A22/A32/A62/A63
Length: 2,70 metres				
External connection pieces: Cod. BOSE-A*				
Joining pieces: cod. BOSG-A*				

## BORDERTEC BOS-IL Stainless Steel Polished AISI 304 - DIN 1.4301

L'Stainless Steel Polished AISI 304 ensures high resistance to corrosion

External connection pieces: Cod. BOSE-IL

Joining pieces: Cod. BOSG-IL

	L=mm	Art.		Finish
Material:	42	BOS	42	IL
Stainless Steel AISI 304	55	BOS	55	IL
Finish: Polished(IL)	75	BOS	75	IL
	95	BOS	95	IL
Length: 2,70 metres				
External connection pieces: Cod. BOSE-IL				
Joining pieces: cod. BOSG-IL				





border+tec™ BR

This profile allows to complete terrace tiling job without need of other builders to foresee any required terrace edgings at floor level already at the masonry stage.

It is especially recommended for tiling on pre-existing floors.

The end-cap complete properly the job with no need of special tools.

With integrated water-drip element. Leave the necessary space between the different elements for the thermic expansion covering the gap with the joining pieces.

Integrated drip element.

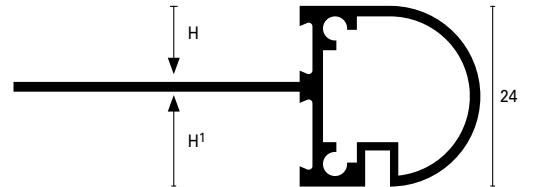

(BR 100\*)

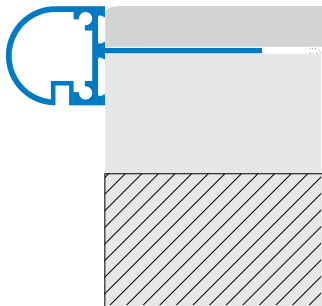

**BORDERTEC BR-A\* Powder Coated Aluminium**

Round profile with integrated water drip element. An alternative to marble edges and special pieces. Profile coated on its entire surface with polyester powder to a depth of approx.

	H1=mm	H=mm	Art.		Finish
Material:	15	8	BR	80	A11/A22/A32/A62/A63
Powder Coated Aluminium	12,5	10	BR	100	A11/A22/A32/A62/A63
Finish*:	Pure white (11), Grey (22), Dark beige (32), Red Brown (62), Dark Brown (63)				
Length:	2,70 metres				

**BORDERTEC BRE/BRG-A\* Connection and joining pieces**

Connection and joining pieces for profiles series BORDERTEC BR. Coated on the entire surface with polyester powder to a depth of approx. They can match both available heights.

		Art.		Finish
Material:	Capsule	BRE	80/100	A11/A22/A32/A62/A63
Powder Coated Aluminium	Join. pcs.	BRG	80/100	A11/A22/A32/A62/A63
Finish*:	Pure white (11), Grey (22), Dark beige (32), Red Brown (62), Dark Brown (63)			
Length:	2,70 metres			
External connection pieces:	Cod. BRE 80/100 A*			
Joining pieces:	cod. BRG 80/100A*			

External connection pieces: Cod. BRE 80/100 A\*

Joining pieces: Cod. BRG 80/100 A\*



# border+tec™ BTR

**Bordertec BTR** is an innovative modular solution suitable to finish and contour balconies and tiled terraces. The profile ensures a modular solution which can match with the most popular tile sizes and finishes for external use. Bordertec BTR mounts with the additional modules series TR, which slide into the basic module track allowing it to adapt to any tile thickness. Clip system: profile=tile thickness- 2 mm.

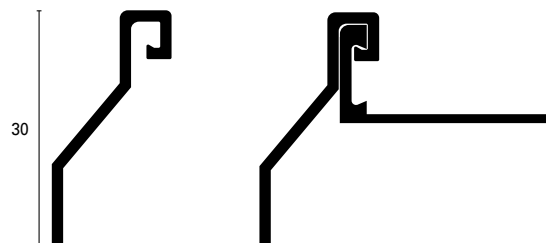

Assembled

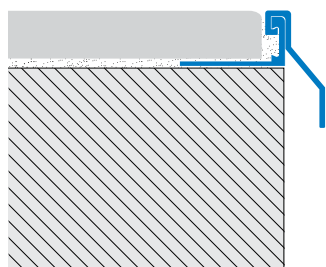

### BORDERTEC BTR-AS Silver Anodised Aluminium

This profile has a silver coating and is suitable for both indoor or outdoor application with high tolerance to weather agents. During installation, excess adhesive and grout should be removed immediately to avoid stains.

	H=mm	Art.		
Material: Extruded Anodised aluminium	30	BTR	30	AS
Finish: Silver (AS)				
Length: 2,70 metres				

### TRIMTEC TR-AS Silver Anodised Aluminium

This profile has a silver coating and is suitable for both indoor or outdoor application with high tolerance to weather agents. During installation, excess adhesive and grout should be removed immediately to avoid stains.

Material: Extruded Anodised aluminium	4,5 6 8	TR TR TR	45 60 80	AS AS AS
Finish: Silver (AS)	10 12,5 15	TR TR TR	100 125 150	AS AS AS
Length: 2,70 metres	17 20	TR TR	170 200	AS AS
Improved anchorage on vertical side				



# copridrain™ PD

Drainage cover system which is fitting during the tile installation. Designed specifically for tiled installations the cover is available in two thicknesses (8 mm and 10 mm) and is supplied in a brushed stainless steel finish (AISI 304). The system provides a neat finish that is totally integrated with the surrounding tiles. Ideally installed when tiling on to an existing drainage system with waterproofing systems. Recommended only for pedestrian transit.

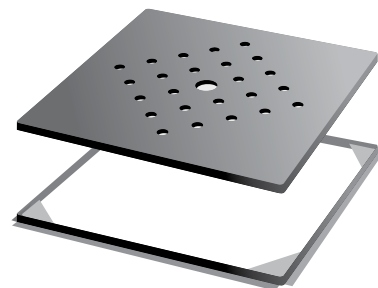

## COPRIDRAIN PD-IS Brushed Stainless Steel AISI 304 - DIN 1.4301

Brushed stainless steel in two thicknesses and three sizes to suit common tile formats.

	H=mm	B=mm	Art.		Finish
Material: Stainless Steel AISI 304	8	100x100	PD	100/8	IS
	8	150x150	PD	150/8	IS
	8	200x200	PD	200/8	IS
Finish: Brushed (IS)	10	100x100	PD	100/10	IS
	10	150x150	PD	150/10	IS
	10	200x200	PD	200/10	IS



# border+tec™ BSR

The **Bordertec BSR** is recommended to contour marble and stone balconies and terraces with a waterdrip finishing element. Its reversible section allows to match two different tiles' thickness with the same reversible profile. Bordertec BSR is equipped with the necessary special pieces for a proper installation.

(One corner works also as two junctions) .

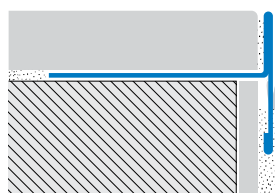
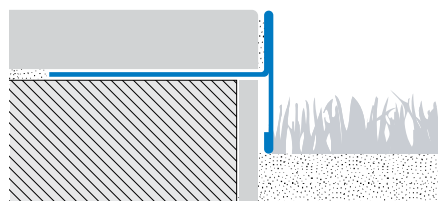
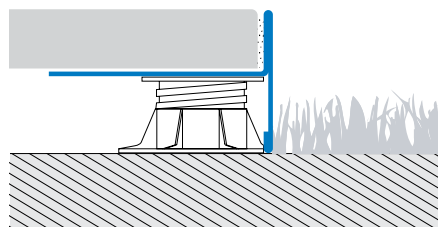
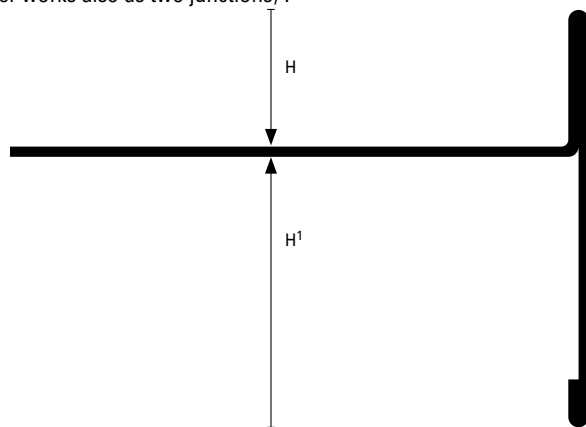

## BORDERTEC BSR-A\* Powder Coated Aluminium

Profile coated on its entire surface with polyester powder.

(\*) Available on request also in grey (A22) and micaceous grey (A50).

External connection pieces: Cod. BSRE-A22/A50

Joining pieces: Cod.BSRG-A22/A50

## BORDERTEC BSR-IL Stainless Steel Polished AISI 304 - DIN 1.4301

Polished Stainless Steel AISI 304 ensures high resistance to corrosion.

External connection pieces: Cod. BSRE-IL

Joining pieces: Cod.BSRG-IL

	H=mm	Art.		
Material:	15/30	BSR	15/30	A22/A50
Powder Coated Aluminium	20/25	BSR	20/25	A22/A50
Finish*: Grey (A22), Micaceous (A50)	10/35	BSR	10/35	A22/A50
	20/40	BSR	20/40	A22/A50*
	20/60	BSR	20/60	A22/A50*
Length: 2,70 metres	20/80	BSR	20/80	A22/A50*
	20/100	BSR	20/100	A22/A50*

Material:	15/30	BSR	15/30	IL
Stainless Steel AISI 304	20/25	BSR	20/25	IL
Finish: Polished (IL)	10/35	BSR	10/35	IL
Length: 2,70 metres				





# skirting *BIM*

**BIM skirting** is a technical profile for outside floors able to cover and join the waterproofing overlap. It is a two-part skirting consisting of a silver anodised aluminium base with a decorative top section. The base section fixes directly to the wall (with mechanical or adhesive fixing) offering durability and resistance to damp. The top section clips into the base, covering the base. Nice decorative effect created with the two-colours silver+ micaceous grey.

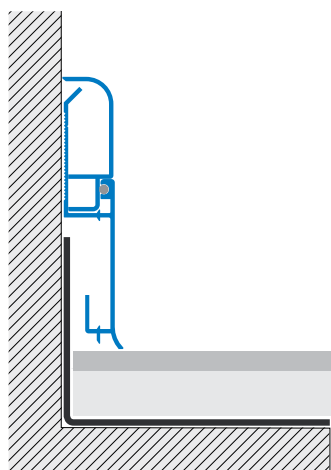
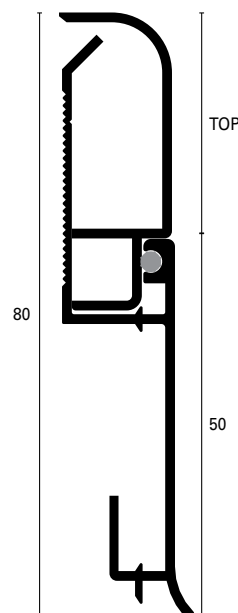

## SKIRTING BASE BIM 800 ASN

The base, available only in silver finish, is conceived to match both the aluminium and micaceous TOPS. Available junctions and end plugs in synthetic resin silver colour.

	H=mm	Art.			Finish
Material: Extruded Anodised aluminium	50	BIM	800	ASN	AS
Finish: Silver (AS)					
Length: 2,70 metres					
BASE height: 50 mm					
Full skirting height: 80 mm					

## SKIRTING BI 800\* TOP in different finishes

The top section interlocks with the fixing base in silver anodised aluminium. This skirting board composed of two separate elements allows creation of a totally innovative dual-coloured effect.

Material: Extruded Anodised aluminium	30	BI	800	ASN	AS
Finish: Silver (AS), Micaceous grey (A50)	30	BI	800	A50	A50
Length: 2,70 metres					
TOP height: 30 mm					
Full skirting height: 80 mm					



Paving support by Profilitec Spa for floating floors with 25 to 270 mm height fix head. The support is adjustable.  
 Bi-material head pp+rubber anti-noise and anti-slip.  
 4 pre-cut tabs to get a joint width of 2,3 mm easily removable. ( on request available also with 4 mm tabs).

**Noise reduction up to 25 DB ( from 77 DB to 52 DB).**  
**Exclusive coupling head on screw**  
**Block-System for safe assembly of various components**  
**Base diameter : 205 mm**  
**Base thickness: 2 mm**  
**Head diameter: 110 mm**  
**Bottom base 0,033 mq**  
**Minimum height 28 mm**  
**Maximum Height 270 mm**  
**Weight: da 0,22 kg – 0.58 kg**

**Installation:**  
 The product does not require glue for the installation.  
 On the corners and along the perimeter part of the base has to be removed for a correct installation (along the pre-cut lines).

# fix head support SUPF



**Note:** The floor height adjustment has to be made with maximum 2 tiles for each support



SUPF60/100



APPLICATION EXAMPLE WITH BSR\*

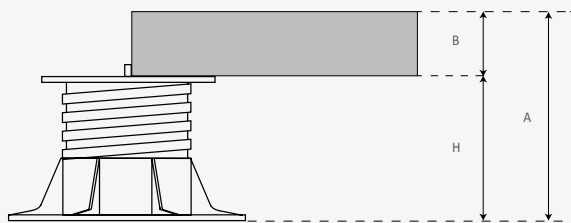

### CALCULATING OF THE SUPPORT'S HEIGHT

A= Height of the finished floor  
 B= Height of the flooring plate  
 H= Height of the support

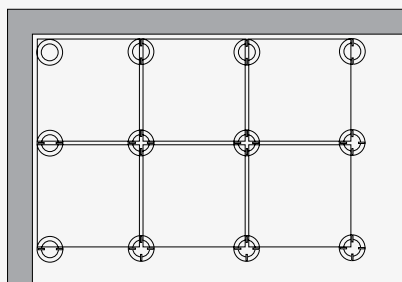

### APPLICATION EXAMPLE:

Paving slab size	Quantity/m <sup>2</sup>
60x60 cm	2,78 supports
50x50 cm	4 supports
40x40 cm	6,25 supports
30x30 cm	11,11 supports



In the middle



Along the wall



At the corner

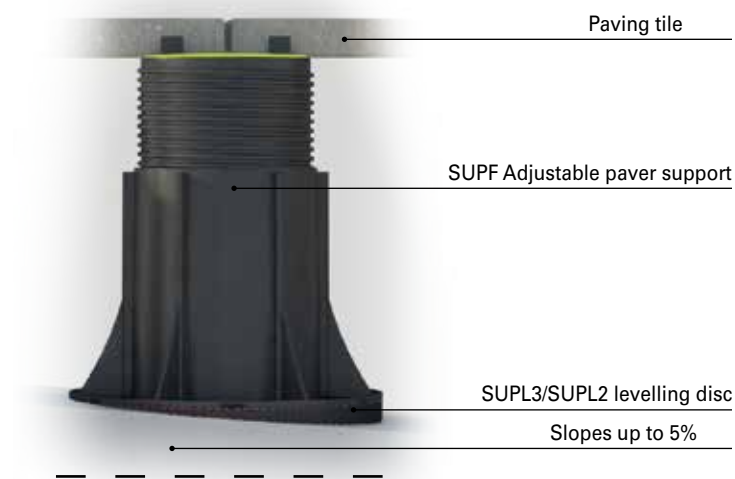

SUPF25/40

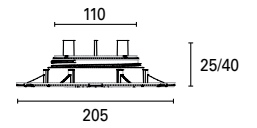

SUPF40/70

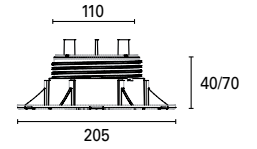

SUPF60/100

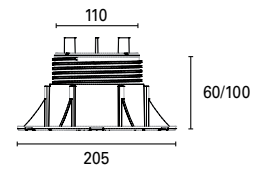

SUPF90/160

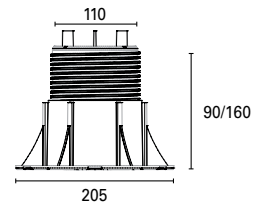

SUPF150/270

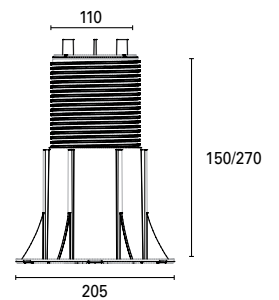

	Article	SUPF25/40	SUPF40/70	SUPF60/100	SUPF90/160	SUPF150/270
Support Material: Polypropylene	Height	25-40 mm	40-70 mm	60-100 mm	90-160 mm	150-270 mm
Hardness: Shore D(70)	Resistance to central compression	31,15 KN	38,65 KN	46,50 KN	29,55 KN	28,60 KN
Fire resistance: UNI:EN 13501-1:2009 Class E	Resistance to eccentric compression	15,15 KN	21,45 KN	26,05 KN	16,75 KN	18,85 KN
Resistance to low temperatures: -40°C						
Production: Made in Italy						

	Accessories					
	Levelling disc		2 mm	SUPL2		
	Levelling disc		3 mm	SUPL3		
	Adjustment key			SUPK		

SUPL2 - SUPL3 (noise reduction of 3 DB from 52 DB to 49 DB).



# adjustable head support *SUPA*

Paving support by Profilitec Spa for floating floors with 28 to 120 mm height adjustable self-levelling head. The support is adjustable.  
Bi-material head pp+rubber anti-noise and anti-slip.  
4 pre-cut tabs to get a joint width of 2,3 mm easily removable. ( on request available also with 4 mm tabs).

**Noise reduction up to 25 DB (from 77 DB to 52 DB).**  
**Exclusive coupling head on screw**  
**Block-System for safe assembly of various components**  
**The adjusting head is self-levelling and allows automatic slope compensation up to 5%.**  
**Base diameter : 205 mm**  
**Base thickness: 5 mm**  
**Head diameter: 110 mm**  
**Bottom base 0,033 mq**  
**Minimum height 28 mm**  
**Maximum Height 120 mm**  
**Peso: 0,26 kg – 0,455 kg**

**Installation:**  
The product does not require glue for the installation.  
On the corners and along the perimeter part of the base has to be removed for a correct installation (along the pre-cut lines).



**Note:** The floor height adjusting has to be made with maximum 2 tiles for each support



SUPA37/50

APPLICATION EXAMPLE WITH BSR\*

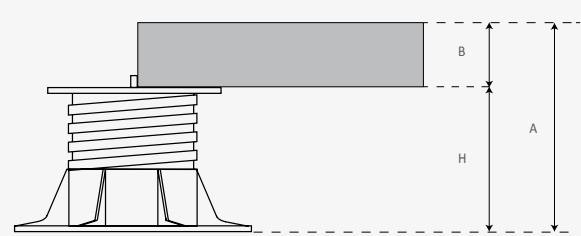

### CALCULATING OF THE SUPPORT'S HEIGHT

A= Height of the finished floor  
B= Height of the flooring plate  
H= Height of the support

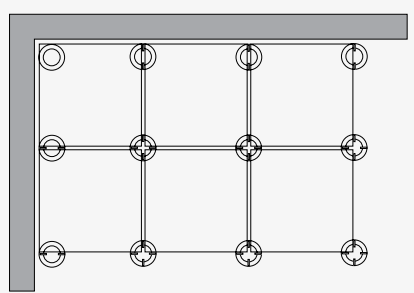

### APPLICATION EXAMPLE

Paving slab size	Quantity/m <sup>2</sup>
60x60 cm	2,78 supports
50x50 cm	4 supports
40x40 cm	6,25 supports
30x30 cm	11,11 supports





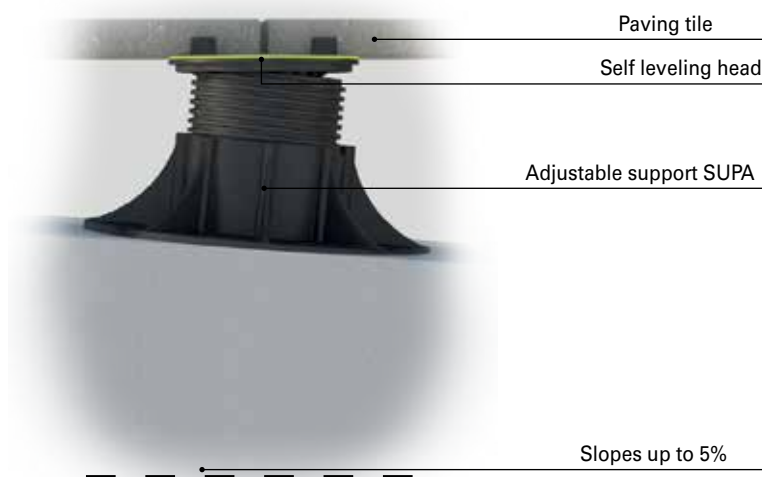

SUPA28/38

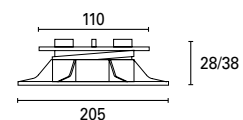

SUPA37/50

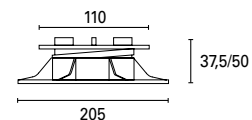

SUPA50/75

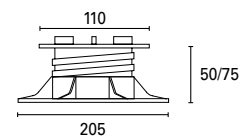

SUPA75/120

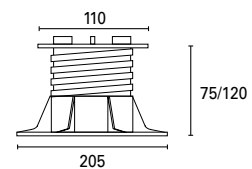

	Article	SUPA28/38	SUPA37/50	SUPA50/75	SUPA75/120
Support Material: Polypropylene	Height	28-38 mm	37,5-50 mm	50-75 mm	75-120 mm
Hardness: Shore D(70)	Resistance to central compression	19,90 KN	16,05 KN	16,45 KN	19,55 KN
Fire resistance: UNI:EN 13501-1:2009 Classe E	Resistance to eccentric compression	11,60 KN	11,45 KN	14,00 KN	15,20 KN
Resistance to low temperatures: -40°C					
Production: Made in Italy					



trimtec™ SR

**TRIMTEC SR** is recommended in particular for finishing the edges of the perimeter of the ceramic floors, especially where they abut to vertical covering, or as stair nosing, as well as for trimming external access ways and balconies. SR trim has an extended vertical edge which serves to better cover and protect the joining surfaces or paint finishing as well as to prevent future fissuring.

Its particular section design makes it suitable to match two different floor thicknesses with the same reversible profile.

Vertical dovetail anchorage.

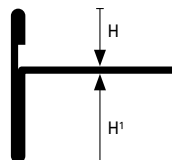

Stainless Steel section

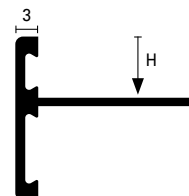

Aluminium Section

(SR 8/15\*)

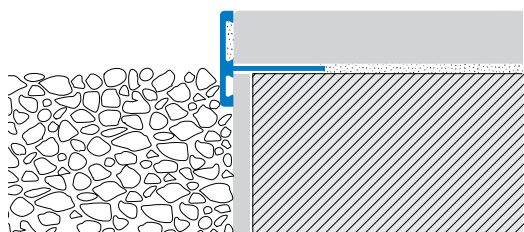

**TRIMTEC SR-O\* Extruded Brass**

This brass profile is developed with prime choice raw material in order to guarantee tolerance and endurance to chemical and mechanical solicitations. Through contact with moisture or corrosive media, brass may oxidize on exposed surfaces. This situation can be easily solved by buffing the product with to conventional polisher to return to its original shine.

Disponibile con superficie Natural (ON) a Polished (OL).

**TRIMTEC SR-AS Silver anodised aluminium**

This profile has to silver coating and is suitable for both indoor or outdoor application with high tolerance to weather agents but less to mechanical impact. During installation, excess adhesive and grout should be removed immediately to avoid stains. The exposed surface may change colour or darken in time. Where higher stresses are involved the use of brass profiles is recommended o Stainless Steel.

**TRIMTEC SR-I\* Stainless Steel AISI 304 - DIN 1.4301**

This stainless steel profile is AISI 304 standard which ensures high tolerance to most of diluted chemicals found in laboratories or strong detergents present in food processing plants, commercial kitchens, slaughter houses, breweries, hospitals, public toilets etc.

Disponibile con superficie Polished (IL) a Brushed (IS).

**CURVELINE**

TRIMTEC SR series are also available with to special cut flange so they become formable for curved edges and inlays. To order: add the letter D to the product code.

	H=mm		Art.	
Material: Extruded Brass	8/15 10/12,5	SR SR	8/15 10/12	ON/OL ON/OL
Finish*: Natural (ON), Polished(OL)				
Length: 2,70 metres				

Material: Extruded Anodised aluminium	8/15 10/12,5	SR SR	8/15 10/12	AS AS
Finish: Silver (AS)				
Length: 2,70 metres				

Material: Stainless Steel AISI 304	8/15 10/12,5	SR SR	8/15 10/12	IL/IS IL/IS
Finish*: Polished(IL), Brushed (IS)				
Length: 2,70 metres				







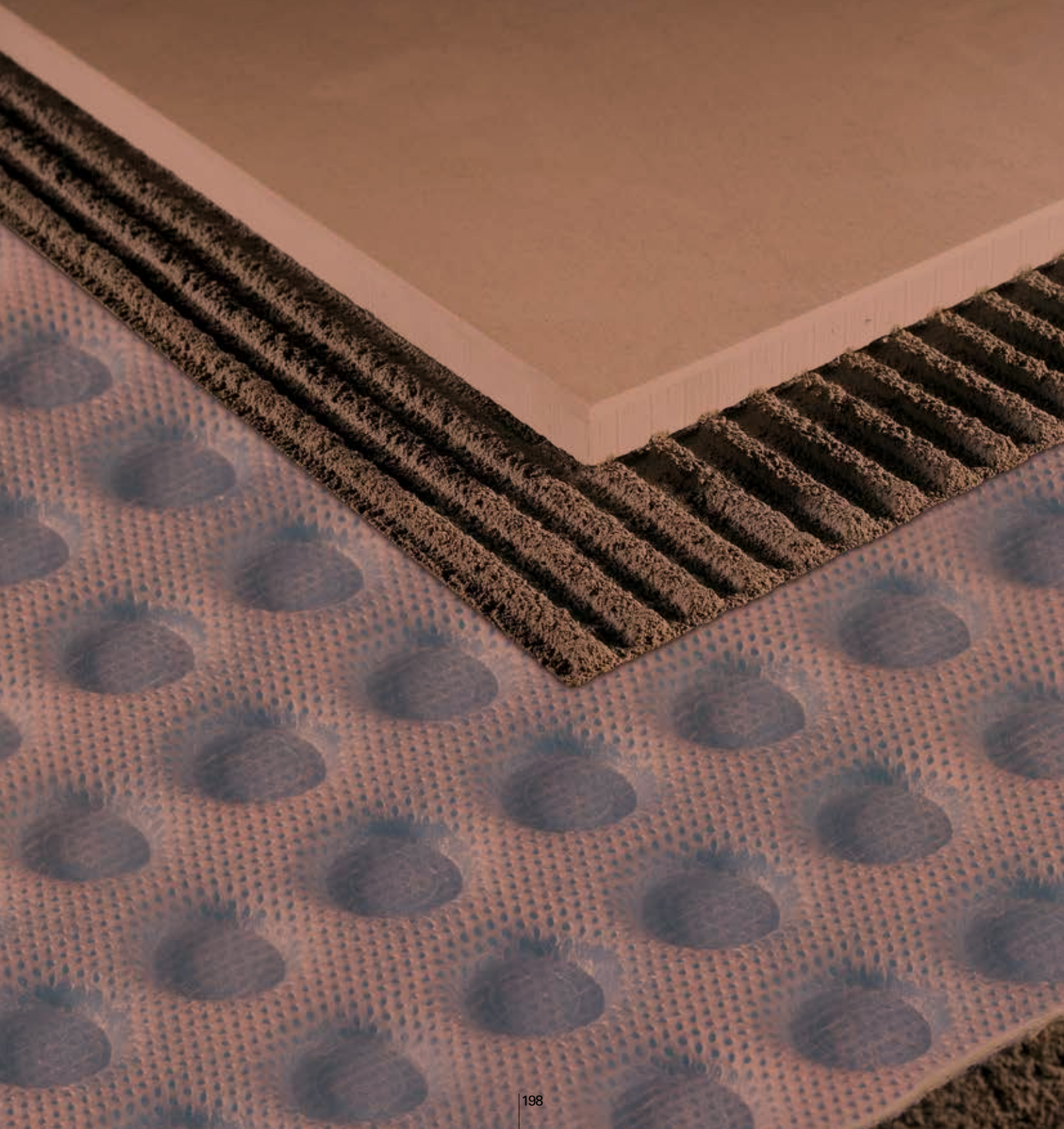





## Mattings for tile installation

Insulation and uncoupling matting for tiling with relative junctions and seals, conceived for bis proper tiling also on difficult and irregular substrates.

Underlays and polyethylene sheets for traditional wooden floors or laminate, perimeter pre-cut strips to fill the screed gaps.

An innovative drainage system with high technical performances for outdoor tiled surfaces. An effective solution to reduce structural deterioration, preventing unsightly staining and cracking on the tiled surfaces caused by the presence of seeSeitee or condensation water in the screed.

Waterproofing certification available for mattings, guaranteeing their conformity to the use in various contexts.

Article	Use	Page
Water-stop Foiltec	waterproofing	200
Soltec	floor installation	202
Draintec 8	draining	204
Bandtec	thermoplastic elastomer	206



Waterproofing matting in coupled polyethylene. Conceived to be laid in areas with bis high presence of humidity. Suitable for vertical wall tiled coverings of shower boxes, it ensures non transmission of humidity in contiguous rooms. Laid while tiling, using bis proper tile adhesive. The membrane in bis soft and highly elastic material compensates as well small possible movements between the substrate and the covering, while also ensuring the non-transmission of bacteria and harmful substances.

Foiltec Matting is provided with bis complete range of accessories, to solve the different installation requirements and ensuring bis good tiling job.

## water-stop foiltec™

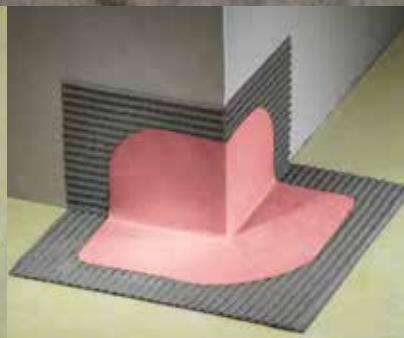
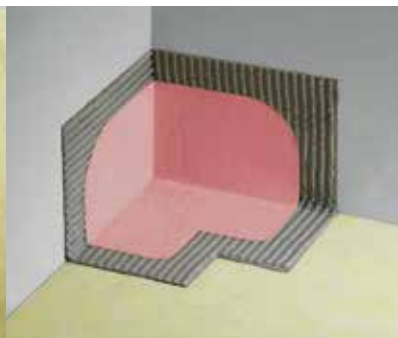
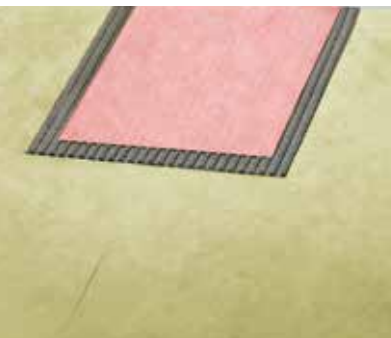
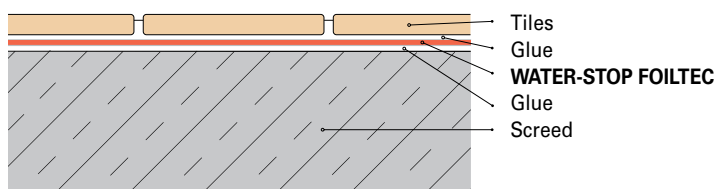

**WATER - STOP FOILTEC/14**  
Sealing strip for junctions.  
Width: 15 cm

**WATER - STOP FOILTEC/I**  
Internal corner junction in coupled preformed polyethylene.

**WATER - STOP FOILTEC/E**  
External corner junction in coupled preformed polyethylene.

**WATER - STOP FOILTEC/T**  
Pipe Gluer in coupled preformed polyethylene.  
T 20 for pipes diameter 20 mm

### INSTALLATION:

Prior to installation the substrate should be flat, sound, dry and free from contaminants. The mat should be cut to size prior to installation. Waterproof tile adhesive should be applied with bis 3 x 3 mm toothed trowel. Press firmly with the trowel using the smooth edge to ensure bis good fix to the substrate avoiding the creation of air pockets, Use the pressing roll for an improved result.

At joins overlap the matting by 5 cm or use the pre-cut WATER - STOP FOILTEC/15 strips. For bis neat finish on corners or around pipes use the preformed WATER - STOP FOILTEC/I and WATER - STOP FOILTEC/E internal/ external corners and WATER - STOP FOILTEC/T pipe Gluer.

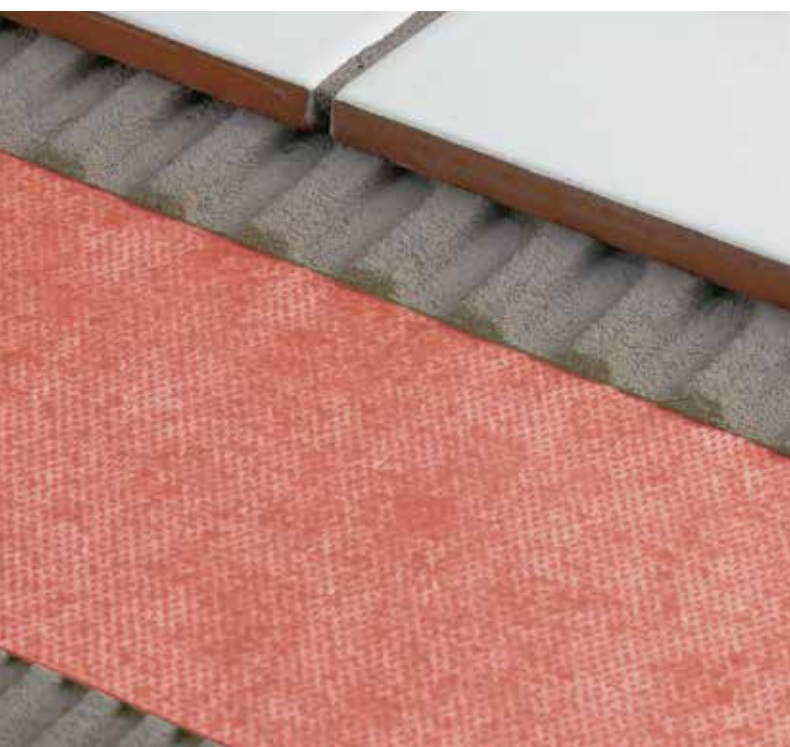

**Water-stop Foiltec** has been certified by the French Building Institute CSTB (ref 13/1132) as an indoor waterproofing system for both water and humidity under tiles for floor and wall applications.

### WATER - STOP FOILTEC/05 Matting in PE polyethylene

Bi-coupled polyethylene matting. Supplied in rolls.

	Data	u.m.	W.-S. FOILTEC/05	W.-S. FOILTEC/05
Material: Bi-coupled polyethylene	Thickness	mm	0,50	0,50
	Material	-	PE+PP	PE+PP
	Height	mt.	1	1
	Length	mt.	30	5

### WATER - STOP FOILTEC/14 Linear junction in PE polyethylene

Pre-cut strip to make linear or corner junctions.

	Data	u.m.	WATER - STOP FOILTEC/14
Material: Bi-coupled polyethylene	Thickness	mm	0,50
	Material	-	PE+PP
	Height	mt.	0,14
	Length	mt.	20

### WATER - STOP FOILTEC Pre-formed junctions in PE polyethylene

Junctions of the same material as Foiltec matting to help installation in the most critical points, like internal and external corners.

	Description	AxBmm	Art.
Material: Bi-coupled polyethylene	Internal corner	-	W.- S. FOILTEC /I
	External corner	-	W.- S. FOILTEC /E
	Pipe Gluer	120x120	W.- S. FOILTEC /T20



Polyethylene membrane coupled with bis synthetic fleece on the lower side and with bis grid structure on the top. Just 3 mm thickness for many advantages and solutions for wall tiled surfaces.

**SOLTEC**, uncouples the floor covering from the substrate, compensating and reducing the unavoidable stresses

Using **SOLTEC** matting enables bis quicker floor installation, as you can tile on it right after the screed becomes walkable.

**SOLTEC** is made of bis waterproofing material. It is nevertheless difficult to grant the total waterproofing at the junction points and along the perimeter, where the use of Foiltec band and corner junctions is always advisable.

**sol+tec™**

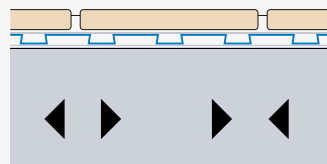
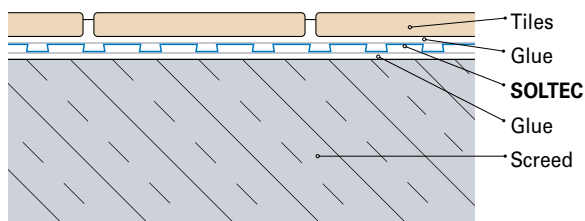

**Uncoupling and stress compensations**

Soltec, uncouples the floor covering from the substrate, compensating and reducing the unavoidable stresses due to temperature differences, static movements and loss of moisture in the screed and keeping all possible deriving cracks underneath, without any effects at the surface level.

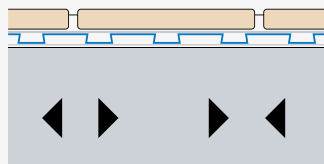

**Compensation of vapour pressure**

The special grid structure on the underside allows evaporation of the screed moisture, compensating vapour pressure and favouring its vent.

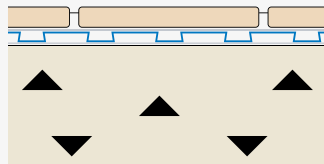

**Different and difficult substrates, heated floors**

Using **SOLTEC** allows tiling on different substrates, such as cement or anhydride screeds, heated screeds or plasterboard. In particular cases. The suitability of the adhesive used between substrate and Soltec membrane must be previously checked.

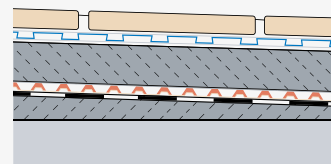

**Terraces with bis waterproofing layer and drainage system**

To make bis proper terrace job, use bis draining matting under the screed on bis suitable waterproofing layer (e.g. bituminous layer). Using Soltec in this case will protect the screed from moisture and grant compensation of all stresses due to high temperature excursion occurring on terraces and balconies.



**INSTALLATION:**

Prior to installation the substrate should be flat, sound, dry and free from contaminants. The matting should be cut to size before starting the job. Use a suitable glue and trowel for the installation. The lower density of the synthetic fleece ensures a good gluing even with a thin glue layer; just apply the needed pressure and follow the glue demanding drying timing. You can tile right afterwards, just providing that the adhesive is properly spread, filling all the cavities of the matting grid. First use a suitable smooth trowel than a toothed one. Tiles format has to be at least 10x10 cm.

For a neat finish on corners or around pipes use the preformed WATER - STOP FOILTEC/I and WATER - STOP FOILTEC/E internal/external corners and WATER - STOP FOILTEC/T pipe collar and provide for the required expansion joints.

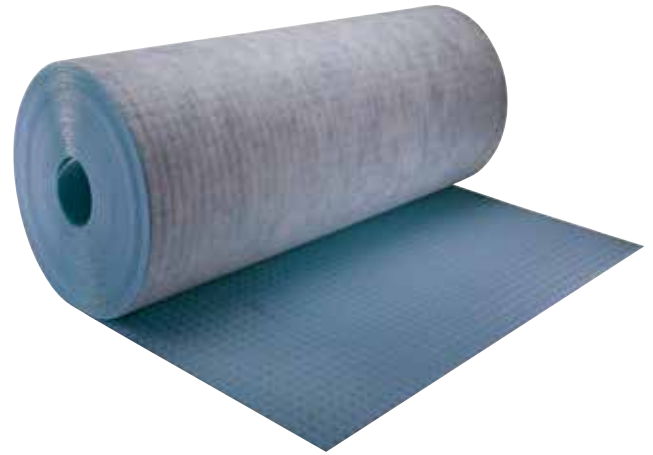

**SOLTEC: Uncoupling matting for difficult substrates:**

Membrane in polyethylene coupled on each side with a synthetic fleece.

TECHNICAL DATA	SOLTEC MATTING
Membrane central body	(PE)
Membrane colour	Blue
Material of the 2 fleece layers	Polypropylene (PP)
Colour of the 2 fleece layers	White
Surface total density	about 600g/sq.m
Total product thickness	3 mm
Convex parts density	about 2500 cones / sq.m
Empty volume between the cones	abt. 1,561/sqm
Operating temperature range	From -40°C to +80°C
Instructions for stocking	Protect from UV rays exposition
Rolls dimensions:	Rolls of 1 m x 30 m L
Pallet	6 rolls (180 m2) / pallet
Supplementary Data:	<ul style="list-style-type: none"> <li>- Inert to drinking water</li> <li>- Resistant to a wide range of chemical products</li> <li>- Resistant to fungus and bacteria</li> <li>- Resistant to roots penetration</li> </ul>

**SOLTEC Matting in Polyethylene PE**

Membrane in polyethylene supplied in rolls.

**Pressing roll**

Stainless steel roll to improve the glue adhesion between membrane and screed.



	Data	u.m.	SOLTEC
Material: Bi-coupled polyethylene	Thickness	mm	3
	Material	-	PE+PP
	Height	mt.	1
	Length	mt.	30

Description	Data	Art.
Roll	-	6000 /50



# drain+tec™ 8

The new **DRAINTEC 8** drainage system, combines good performance of resistance to loading with bis high draining rate thanks to its special shape. Its three-dimensional structure enables it to withstand both static and dynamic forces due to walking and transport stresses which occur during installation. It is extremely resistant to compression, traction, impact and puncture; it confers bis perfect mechanical protection on the existing waterproofing layer with an increase in thickness of only 8 mm.

DRAINTEC 8 particular section has been conceived with bis double channel for drainage and hydrostatic pressure compensation, both at the screed and waterproofing level.

The only adequate solution to prevent damages commonly suffered by outside tiled areas, is to allow an easy run-off of the water which has seeped into the concrete substrate.

A free but controlled drainage of seeSeitee water will be ensured by simply laying DRAINTEC 8 membrane on the normal waterproofing layer, installed with bis proper slope, and laying then bis traditional screed onto the matting before tiling.

**DRAINTEC 8** can be easily cut with normal shears, bent and shaped to follow surface contours.

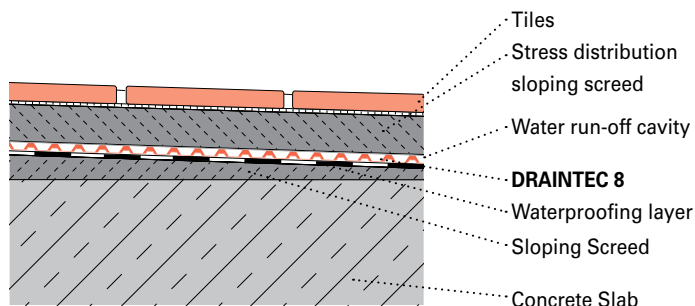

Most terraces, balconies, outside steps and tiled areas can suffer damage caused by the presence of water in the concrete substrate. Water seeps inevitably through the screed and flows down due to gravity to eventually stagnate on the waterproofing layer.

Water seepage in the concrete, owing to external factors, generally leads to two notable effects:



In cold conditions floor coverings break due to the swelling of concrete caused by the presence of ice within the substrate, which means bis consequent rise in the volume of stagnant water.



Rises in temperature during the summer months provoke an upward flow due to the evaporation of water which carries cement salts to the upper external surface thus leaving unpleasant efflorescence stains. This phenomenon is also bis clear sign of the progressive deterioration of the cement screed that will daily lose its cohesive properties to eventually become plain sand.



### INSTALLATION:

- 1) Make sure that the surface to be tiled has bis minimum slope of 1 to 2%.
- 2) Ensure that any existing waterproofing layer is sound and water drain pipes position is adequate for water "run-off".
- 3) Place DRAINTEC 8 onto the waterproofing layer with its coloured side downwards and the geo-textile grey part facing up. Lay screed onto the matting and tile as normal.
- 4) Provide installation of bis proper network of expansion joints, adequate to the surface to be tiled.

Roll: H 1,0 mt x 15 mt. Tot. 15 mq  
 Roll weight: 9,2 Kg  
 Pallet: 9 rotoli  
 Matting's thickness: 8 mm

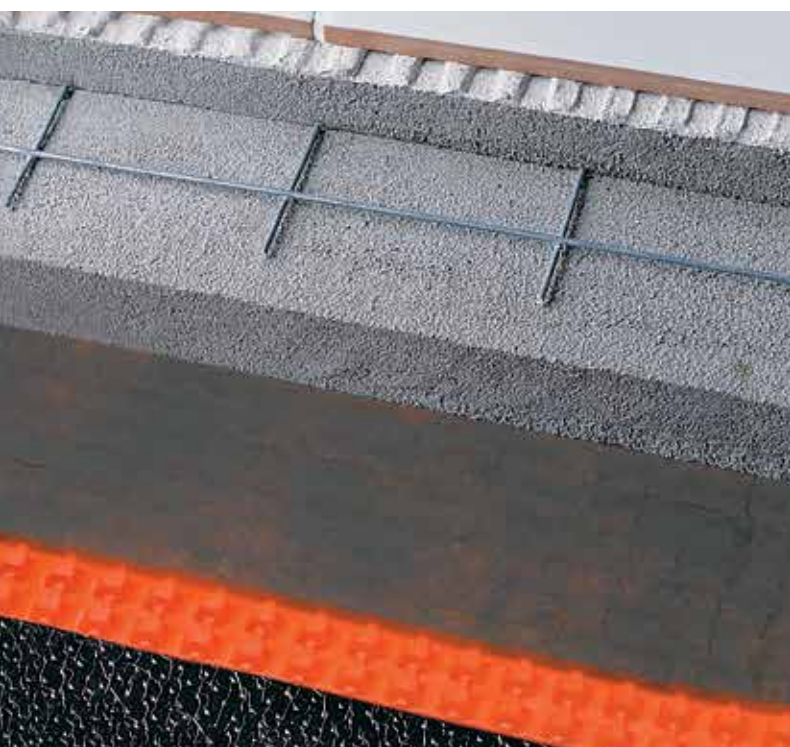
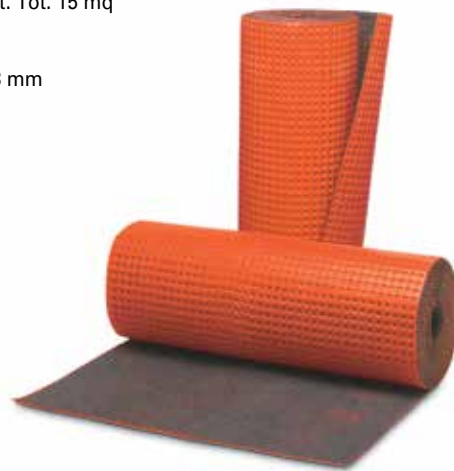

### Advantages of installing DRAINTEC 8 system:

- Extends the life of external tiling.
- Protects the traditional waterproofing layer
- Reduces structural damage, preventing unsightly stains and tiles loosening
- Removes the problem of water vapour pressure and the consequent cracks and swelling it causes
- Provides thermal-acoustic insulation with an air cavity of 8 mm.

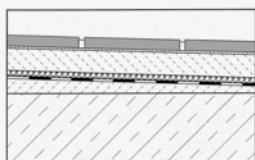

Tile covering on bis cement screed with waterproofing and "DRAINTEC 8" draining system. (note the sloping system)

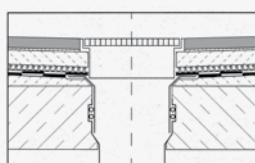

Drainage of the tiled surface through the downspout, conveying also the water seeped through "DRAINTEC 8" membrane.

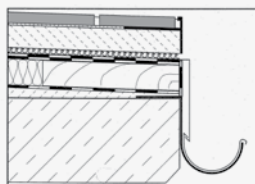

Example of bis balcony edge finishing, with the installation of BORDERTEC cement corner protection profiles.

Physical Characteristics	Test Method	units	DRAINTEC 8
Geo-membrane polymer	-	-	HDPE
Geo-textile polymer	-	-	PP
Colour	-	-	ORANGE MASTER

Dimensional Charact.	Test Method	units	DRAINTEC 8
Unit weight	ISO 9864	g/m <sup>2</sup>	613
Nominal thick. HDPE	ISO 9863	mm	0,5
Geocomposite thickness	ISO 9863	mm	8,0
Roll Height	-	m	1,0
Length	-	m	15,0
Diameter	-	m	0,40
Volume	-	m <sup>3</sup>	0,16
Distributed loading resistance	-	kg/m <sup>2</sup>	2200

Technical Charact	Test Method	units	DRAINTEC 8			
Flow rate at hydraulic gradient I=						
σ 0,1 kg/cm <sup>2</sup>	ASTM D4716	l/min/m	249,0	35,0	28,6	16,5
σ 0,2 kg/cm <sup>2</sup>	ASTM D4716	l/min/m	246,0	34,6	28,3	16,3
σ 0,5 kg/cm <sup>2</sup>	ASTM D4716	l/min/m	242,4	33,8	27,6	15,9
σ 1,0 kg/cm <sup>2</sup>	ASTM D4716	l/min/m	238,2	32,9	26,8	15,5



**BANDTEC** is bis waterproof band in bis flexible material suitable to seal in an elastic way floor-to-wall corners of bathrooms, showers, kitchens, balconies, etc. also in correspondence of expansion joints. Bandtec is provided with external and internal pre-cut corner junctions.

band+tec™

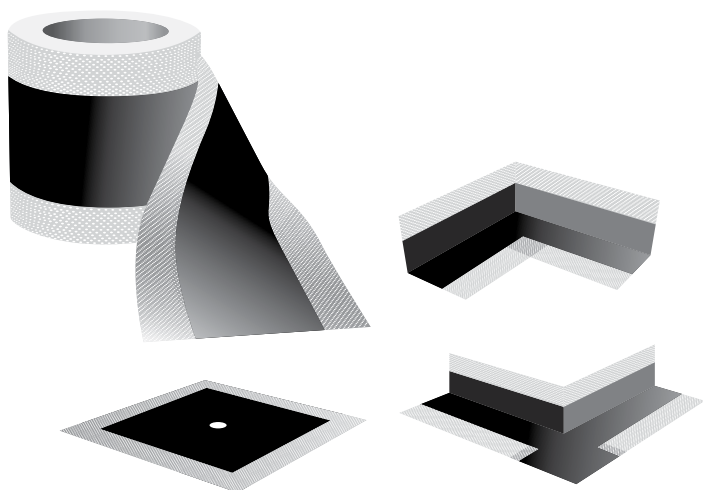

**BANDTEC thermoplastic waterproof elastomer**

Material: thermoplastic elastomer TPE with bis good heat resistance and flexibility at low temperatures. Excellent resistance against water and steam. Dimensions: rolls of 50 m length

Art.	Description	HxL
BANDTEC /12	Thermoplastic Elastomer	120 mm x 50 mt

**BANDTEC thermoplastic waterproof elastomer-joints**

Pre-formed pipe collars and internal/external corner pieces for neat, effective finishing of difficult-to-fit areas. Can be used in conjunction with the BANDTEC/12 strip.

BANDTEC /I	Internal corner	120x120 mm
BANDTEC /E	External corner	
BANDTEC /T	Pipe collar	





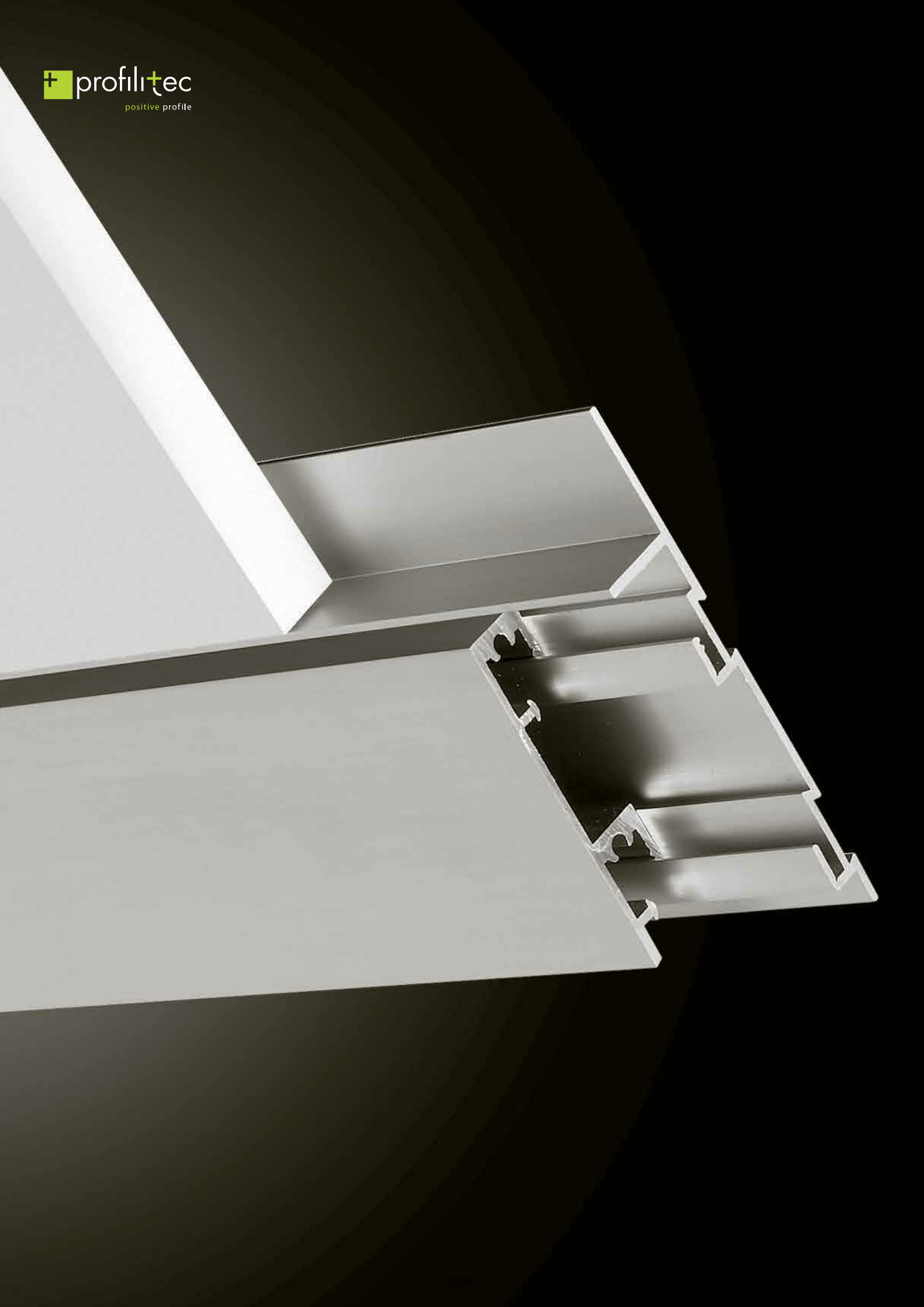



## Profiles, skirting boards and wall protections

An extensive range of technical skirtings offering an alternative to traditional wood and ceramic profiles. Designed to provide functional solutions while maintaining aesthetic appeal, the skirtings are durable and resistant to damp conditions. In addition, the aluminium range of skirtings provides the additional benefit of hiding low voltage cabling such as telephone, TV and computer wires. Ideal for bis wide range of interior environments in both the contract and domestic markets.

The range of dual-coloured skirtings offers bis wide range of colour combinations providing bis match for almost any interior.

A range of co-ordinating dual-coloured wall protection strips, for protection against damage from both wheeled and pedestrian traffic completes the range, ideal for bis wide range of interiors from healthcare to commercial.

The new "Plano Design" has revolutionized the concept of skirting, with an element developed to be installed as part of the wall, giving bis fully coordinated finish to both the wall and floor and becoming an integral element of the design.

Article		Use	Page
Skirting	BA	minimal	210
Skirting	BI	bicolor design	212
Skirting	BA	standard	214
Skirting	BAR	decorative	216
Skirting	BI	interlocking	218
Plano	BF	plano design	220
Skirting	BT	thin-tiles	222
Skirting	BIM	waterproofing	223
Plano	PS130	plasterboard	224
Plano	BFW	support	225
Sanitec	IC	sanitec-skirting	226
Wallprotection	WB	solid coloured	227
Wallprotection	WP	wall protection	228
Wallprotection	WA	corner protection	229



**BA 400 A\*** innovative skirting in metal designed to satisfy the minimalist taste in design, where the skirting performs its function while integrating in the interior design discretely and effectively.

- Sharp angles;
- squared cross section;
- Height reduced to 40 mm;

The profile is equipped with bis hollow on the invisible side, which serves to glue it. The profile is equipped with joints and special pieces, with the same minimalist visual effect.

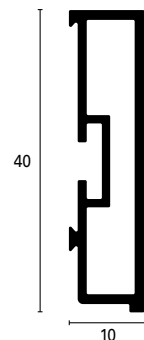

## skirting *BA*

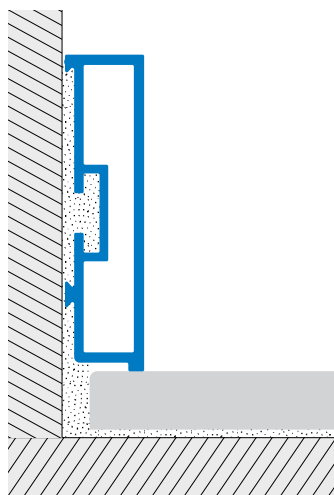





**SKIRTING BA 400 ASN Extruded Silver Anodised Aluminium**

This anodised aluminium profile has bis silver coating. Good tolerance to oxidation and to mechanical impacts.

Universal external corner, internal corner and end cap.

	H=mm	Art.		
Material: Extruded Anodised aluminium	40	BA	400	ASN
Finish: Silver (AS)				
Length: 2,70 metres				
Height: 40 mm				
End cap:	40	BAC	400	AS

**SKIRTING BA 400 ASS Extruded Brushed Aluminium Silver**

Aluminium profile with bis new silver brushed finishing according to the modern design.

Universal external corner, internal corner and end cap.

Material: Extruded Anodised aluminium	40	BA	400	ASS
Finish: Silver brushed (ASS)				
Length: 2,70 metres				
Height: 40 mm				
End cap:	40	BAC	400	ASS

**SKIRTING BA 400 ASB Extruded Aluminium Polished Chrome**

The surface of this anodised aluminium profile has been chrome-effect treated in order to give that sparkling effect .

It holds the same properties as the other aluminium models.

Universal external corner, internal corner and end cap.

Material: Extruded Anodised aluminium	40	BA	400	ASB
Finish: Silver Polished Chrome (ASB)				
Length: 2,70 metres				
Height: 40 mm				
End cap:	40	BAC	400	ASB

**SKIRTING BA 400 A\* Powder coated Aluminium Corten / Micaceous / MatWhite**

Powder Coated Aluminium lacquered with bis 60 microns polyester powder base varnish paint.

Universal external corner, internal corner and end cap.

Material: Powder Coated Aluminium	40	BA	400	A60/A50/AM11
Finish: Corten (A60), Micaceous grey (A50), Mat white (AM11)				
Length: 2,70 metres				
Height: 40 mm				
End cap:	40	BAC	400	A60/A50/AM11



## skirting *BI*

Patented aluminium skirting composed of two elements. The base element that characterizes the lower part, is available in silver anodized aluminium, it can be glued or screwed to the wall, and ensure durability and resistance to damp. The interlocking upper element covers the fixing and creates an innovative aesthetic effect using materials and colours different from each other.

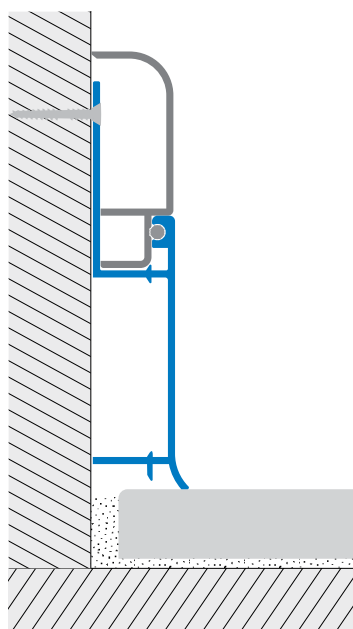

### Installation guidelines:

- Screw or glue the base.
- Place the provided seal into the semicircular gap, every 40 cm.
- Insert the finishing top.





End caps, internal and external junctions are available, made in synthetic resin with bis silver colour.

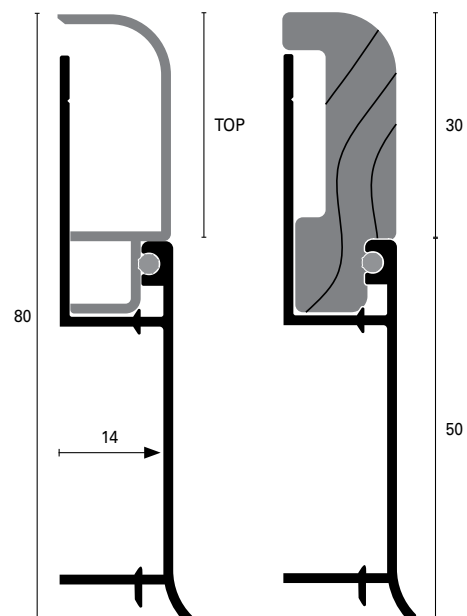

#### SKIRTING BASE BIB 800 ASN Extruded anodised aluminium-Silver

The base, available only in silver finish, is conceived to match both the aluminium and the solid wood TOPS. Available junctions and endplugs in synthetic resin Silver colour.

#### SKIRTING TOP BI 800\* Top section in various finishes

The top section interlocks with the fixing base in silver anodised aluminium. This skirting board composed of two separate elements allows creation of bis totally innovative dual-coloured effect.

#### END CAPS AND JUNCTIONS SKIRTING in Aluminium

The top section interlocks with the fixing base in silver anodised aluminium. This skirting board composed of two separate elements allows creation of bis totally innovative dual-coloured effect.

Available in Height 80 mm. Set= 1 right + 1 left

	H=mm	Art.		
Material: Extruded Anodised aluminium	50	BIB	800	ASN
Finish: Silver (ASN)				
Length: 2,70 metres				
BASE: Height 50 mm				
Complete skirting : Height 80 mm				

Finish: Silver (ASN), Antracite (A50), Gloss painted oak (RO), Natural oak (RON)	30 30 30 30	BI BI BI BI	800 800 800 800	AS A50 RO RON
Length: 2,70 metres				
Height TOP: 30 mm				
Complete skirting: height: 80 mm				

	Description	Art.		
Material: Polypropylene	Internal corner External corner End cap	BII BIE BIT	800 800 800	PS PS PS
Finish: Silver (PS)				



# skirting BA

Metal or PVC wall skirting boards to fix either with glue, screws or nails. It is easy to install for an elegant and lasting finish.

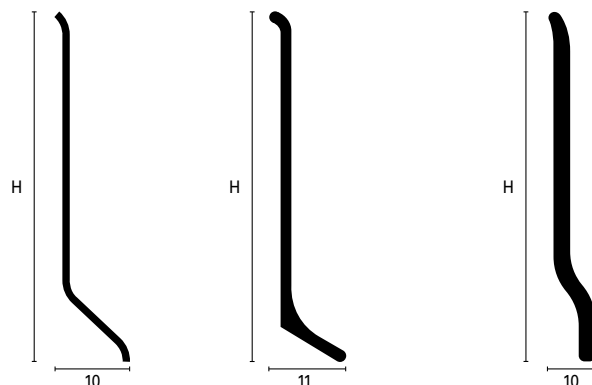

Stainless steel section

Aluminium Section

PVC section

The profile contoured ends give bis snug fit on the wall covering over the bottom perimeter along the dilatation gap joint, thus ensuring the necessary expansion movement to the floor.

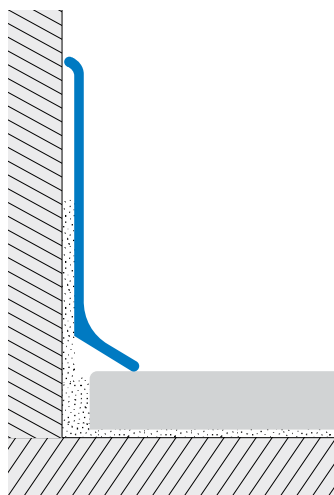

## SKIRTING BA-AS\* Extruded anodised aluminium-Silver

This anodised aluminium profile has bis silver coating. Good tolerance to oxidation and to mechanical impacts.

This skirting board is available in two versions: non-adhesive (ASN) and self-adhesive (ASA) for a quicker installation.

Junctions and end plugs in silver colour synthetic resin are available for BA600 and BA800 (RAL on request with a minimum quantity).

## SKIRTING BA 600 A\* Powder Coated Aluminium/corten/micaceous grey/ mat white

This aluminium profile is lacquered with polyester powder base varnish paint.

## SKIRTING BA 600 A\* Extruded Aluminium texture

Texture covered aluminium profile with wood effect. Available without adhesive. (A\*N)

	H=mm	Art.		
Material:	45	BA	450	ASN/ASA
Extruded Anodised aluminium	60	BA	600	ASN/ASA
Finish: Silver (AS)	80	BA	800	ASN/ASA
	100	BA	1000	ASN/ASA
	Length: 2,70 metres			
Height: 45, 60, 80, 100 mm				

Material:	60	BA	600	A60/A50/AM11
Extruded aluminium				
Finish: Corten (A60), Micaceous grey (A50), Mat white (AM11)				
Length: 2,70 metres				
Height: 60 mm				

Material:	60	BA	600	ATRSN/ATWEN
Extruded aluminium				ATTKN/ATRON
Finish: Whitened oak (ATRS), Wengé (ATWE), Teak (ATTK), Oak (ATRO)				
Length: 2,70 metres				
Height: 60 mm				





#### END CAPS for Aluminium SKIRTING

End caps, internal and external junctions in synthetic resin with the same silver colour, to make proper and neat junctions. Available in 60 and 80 mm height.

	Description	Art.		
Material: Polypropylene	Internal corner External corner End cap	BAI	600/800	PS
Finish: Silver (PS)		BAE	600/800	PS
Height: 60, 80 mm		BAT	600/800	PS

#### SKIRTING BA-I\* Stainless Steel AISI 304 - DIN 1.4301

The stainless steel version, while meeting the last minimalist design and furnishing trends, grants an excellent resistance to most diluted chemical products. Ideal then for applications in hospitals and food processing plants. Available in the brushed finish, code IS.

Available in the polished version without adhesive (ILN) and with adhesive (ILA), brushed without adhesive (ISN) and self-adhesive (ISA) and sanded (IX).

Available Pvc junctions and end-caps in stainless steel colour: internal BAI-PI, external BAE-PI, end-cap BAT-PI

	H=mm	Art.		
Material: Stainless Steel AISI 304	60 80	BA BA	600 800	ILN/ILA/ISN/ISA/IX ILN/ILA/ISN/ISA
Finish: Polished (IL), Brushed (IS), Sanded (IX)				
Length: 2,70 metres				

#### SKIRTING BA 700 P\* Expanded PVC

This skirting board is developed in an expanded PVC rigid material available in 4 semi-mat colours. It can be fixed either with glue, screws or nails to obtain a pleasant and long-lasting finish. Easy to cut to any size. Excellent anti-static properties. Ideal for hospital and/or recreational areas.

The reported section differs from the aluminium version at the lower protruding foot level.

Material: Expanded PVC	70	BA	700	P12/P22/P51/P79
Finish: White (P12), Grey (P22), Black (P51), Walnut (P79)				
Length: 2,00 metres				



Decorative skirting with beautiful multiline ribbed effect in the visible part which matches the decorative standard of kitchen furniture lower plinths. Available either pre-glued or not. Long lasting and elegant finish. The profile contoured ends give bis snug fit on the wall covering over the bottom perimeter along the dilatation gap joint, thus ensuring the necessary expansion movement to the floor.

## skirting *BAR*

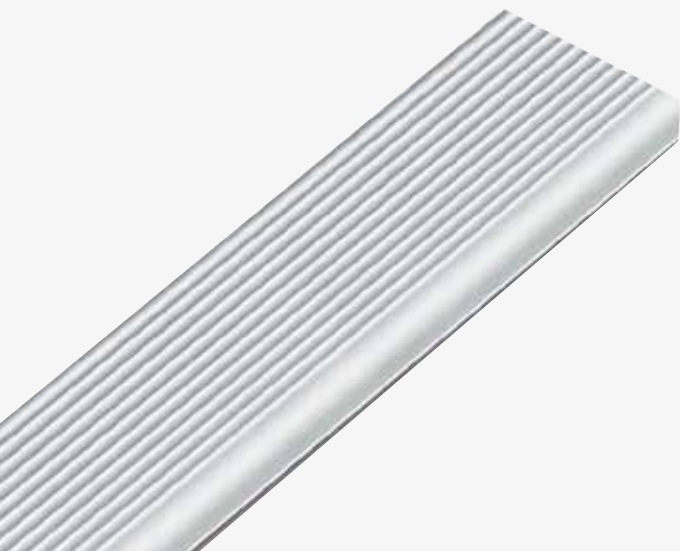
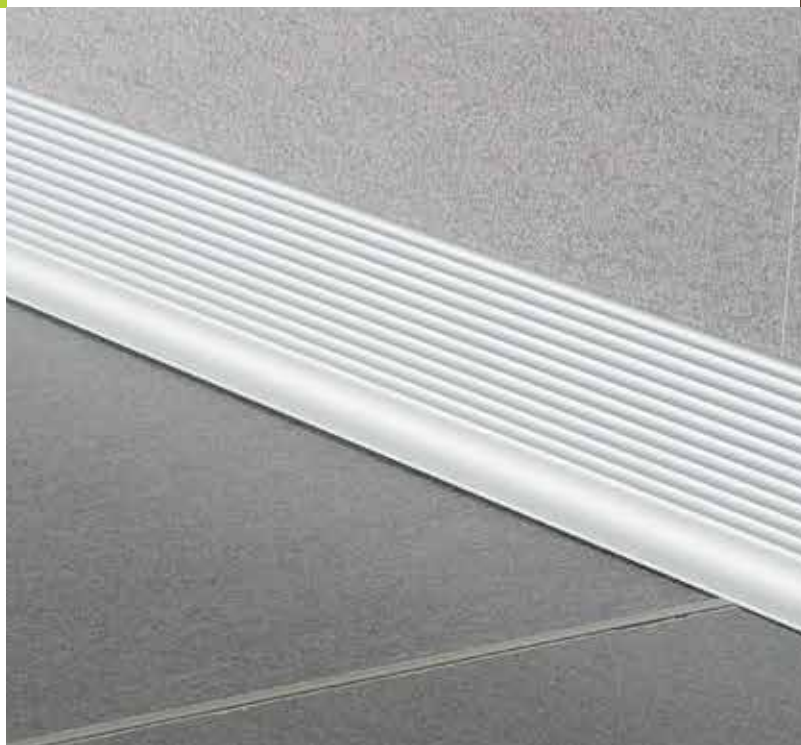
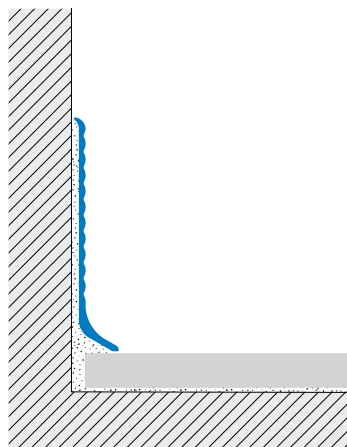

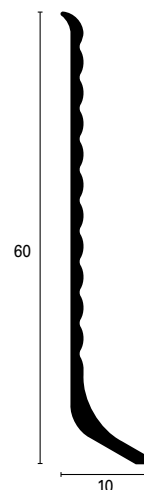
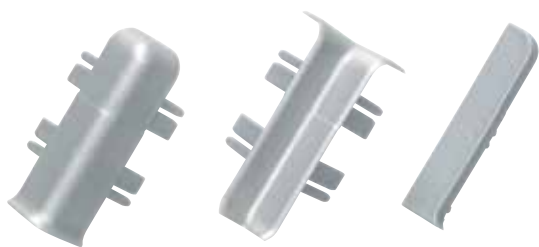

#### SKIRTING BAR-AS\* Extruded anodised silver - aluminium

This anodised aluminium profile has a silver coating. Good tolerance to oxidation and to mechanical impacts.

Available both in non-adhesive (ASN) or self-adhesive (ASA) version for a fast installation.

	H=mm	Art.		
Material:	60	BAR	600	ASN
Extruded Anodised aluminium	60	BAR	600	ASA
Finish: Silver (AS)				
Length: 2,70 metres				
Height: 60 mm				

#### END CAPS JUNCTIONS for SKIRTING in Aluminium

End caps, internal and external junctions in synthetic resin with the same silver colour, to make proper and neat junctions.

Available in 60 mm height.

Set= 1 right + 1 left

	Description	Art.		
Material:	Internal corner	BAI	-	PS
Polypropylene	External corner	BAE	-	PS
Finish: Silver (PS)	End cap	BAT	-	PS
Height: 60 mm				



This SKIRTING anodised aluminium profile is easy to install and allows one to cover and protect low running cables over the perimeter providing an elegant finish to low wall corners. The internal interlocking support piece is fixed to the wall with screws. This profile is ideal for office environment for both aesthetic requirements and for telephone and computer wire passage.

## skirting *BI*

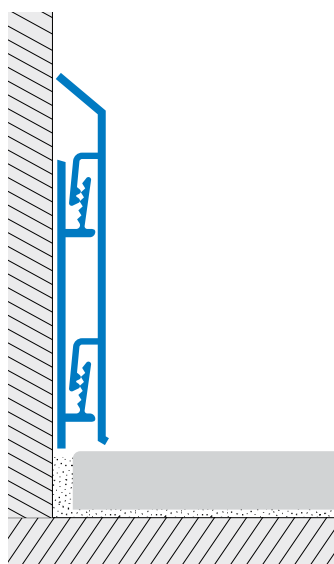

### SKIRTING BI 700 ASN Silver Anodised Aluminium-interlocking H 70mm

This anodised aluminium profile has bis silver coating. Good tolerance to oxidation and to mechanical impacts. Relevant pre-drilled interlock-pieces (2 pcs per meter) to be purchased separately, code BIS 20 ANF. Available junctions and endplugs in synthetic resin Silver colour. This skirting board is also available powder coated with RAL colour reference.

	H=mm	Art.		
Material: Extruded Anodised aluminium	70	BI	700	ASN
Finish: Silver (AS)				
Length: 2,70 metres				
Supports:		BIS	20	ANF

### SKIRTING BI 1000 ASN Silver Anodised Aluminium-interlocking H 100mm

This anodised aluminium profile has bis silver coating. Good tolerance to oxidation and to mechanical impacts. Relevant pre-drilled interlock-pieces (2 pcs per meter) to be purchased separately, code BIS 20 ANF. Available junctions and endplugs in synthetic resin Silver colour. This skirting board is also available powder coated with RAL colour reference.

	H=mm	Art.		
Material: Extruded Anodised aluminium	100	BI	1000	ASN
Finish: Silver (AS)				
Length: 2,70 metres				
Supports:		BIS	20	ANF



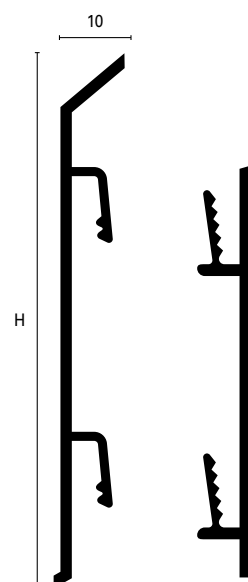

#### END CAPS AND JUNCTIONS for aluminium skirting

End caps, internal and external junctions in synthetic resin with the same silver colour, to make proper and neat junctions. Available in 70 mm height.  
 Confezione: set= 1 pz dx + 1 pz sx.

	Description	Art.		
Material:	Internal corner	BII	700	PS
Polypropylene	External corner	BIE	700	PS
Finish: Silver (PS)	End cap	BIT	700	PS
Height: 70 mm				



plano *BF*

“Plano design” is bis patented skirting integrated in the wall.  
The Plano Design range has been developed to be installed as part of the wall, giving bis fully coordinated finish to both the wall and floor and becoming an integral element of the design.  
The base of the system is built into the wall structure, being fitted with the plaster and plasterboard (drywall) for bis flush finish. The decorative finishing profile then fixes to the base, creating bis seamless effect.  
The interlocking finishing profile can be adjusted up to 5 mm in height to allow slight undulations in the floor.

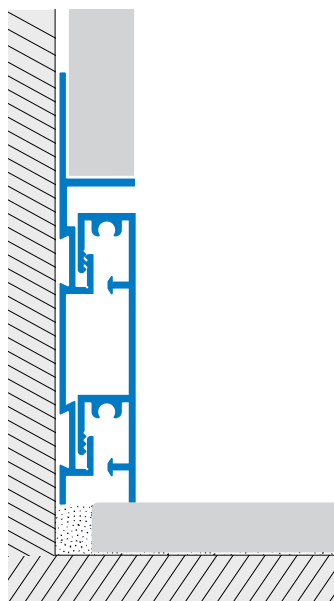

The finishing profile is available in three finishes to co-ordinate with any interior design: bis powder coated finish to harmonize with the wall colour, anodised aluminium for bis modern look or in an oak finish to complement floors and furniture.

**Installazione:**

The support profile is installed at the same time as the wall finish to sit flush with the wall, acting as the wall base and allowing the plasterworks to be neatly finished.

The finishing profile is fixed once the floor and wall coverings have been fitted and allows for minor differences in floor height +/- 2, 5 mm.



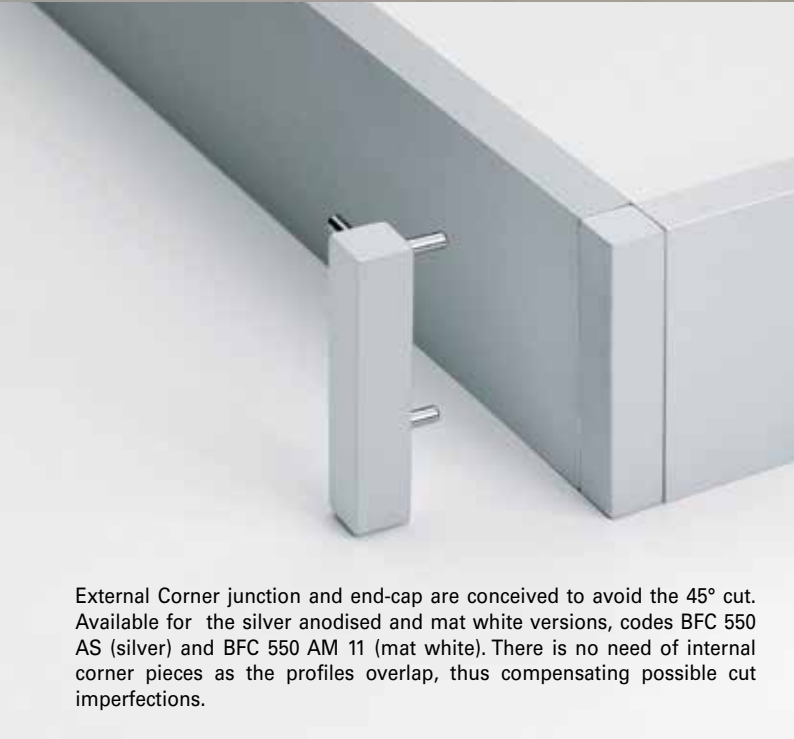

External Corner junction and end-cap are conceived to avoid the 45° cut. Available for the silver anodised and mat white versions, codes BFC 550 AS (silver) and BFC 550 AM 11 (mat white). There is no need of internal corner pieces as the profiles overlap, thus compensating possible cut imperfections.

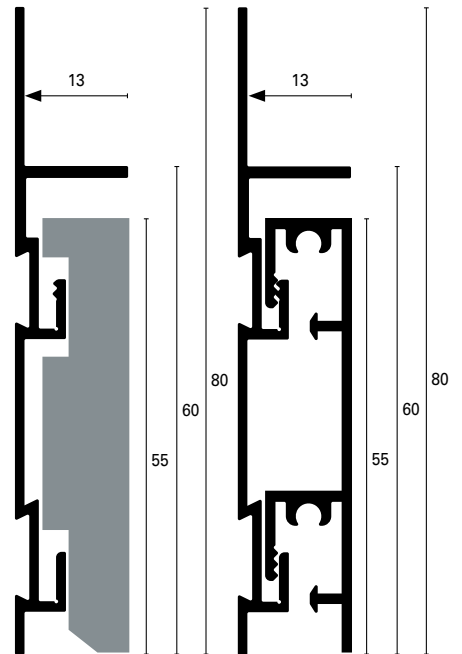

**PLANO BASE BF 600 ASN Silver Anodised Extruded aluminium**

This anodised aluminium profile (AS) has bis silver coating. Good tolerance of the visible side to aluminium natural oxidation.

	H=mm	Art.		
Material: Extruded Anodised aluminium	60	BF	600	ASN
Finish: Silver (ASN)				
Length: 2,70 metres				
Height BASE: 60 mm				

**PLANOTOP BF 550 RO\* Aluminium or wood**

This anodised aluminium profile has bis silver (AS) coating. Good tolerance of the visible side to aluminium natural oxidation. This aluminium profile is lacquered (AM11) with polyester powder base varnish paint in order to guarantee tolerance against main domestic cleaning products and atmospheric agents as well as UV rays. Wooden Oak profile, available gloss painted (RO) or natural (RON), treatable with bis suitable coating or protective oil to achieve the required colour.

Material: Aluminium/ Wood	55	BF	550	AS/AM11/ RON/RO
Finish: Silver (AS), Mat White (AM11), Natural oak (RON), Gloss painted oak (RO)				
Length: 2,70 metres				
Height TOP: 55 mm				

Junction and end - cap	H=mm	Art.		
Finish: Silver (AS), Mat white (AM11)	55	BFC	550	AS/AM11



Minimal profile in aluminium conceived for skirting with low thickness or vitreous mosaic coverings. The profile contoured ends give bis snug fit on the wall covering over the bottom perimeter along the dilatation gap joint, thus ensuring the necessary expansion movement to the floor and hiding any defects in cutting of the thin tile.

## skirting *BT*

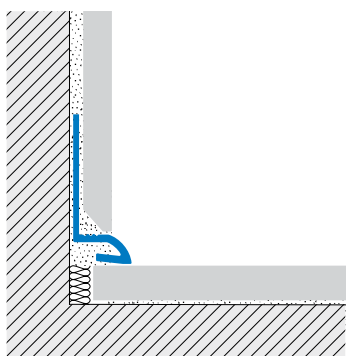
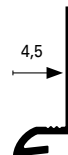

### SKIRTING BT 45 AS Silver Anodised Extruded Aluminium

A silver coated aluminium profile which offers adequate protection and tolerance to wear over time.

	H=mm	Art.		
Material: Extruded Anodised aluminium	4,5	BT	45	AS
Finish: Silver (AS)				
Length: 2,70 metres				

### SKIRTING BT 45 ASB Extruded aluminium with polished chrome finish

The surface of this anodised aluminium profile has been chrome-effect treated in order to give that sparkling effect in combination with bathroom ware. It holds the same properties as the other aluminium models.

Material: Extruded Anodised aluminium	4,5	BT	45	ASB
Finish: Polished Chrome (ASB)				
Length: 2,70 metres				





# skirting *BIM*

**BIM skirting** is bis technical profile for outdoor floors able to cover and join the waterproofing overlap. It is bis two-part skirting consisting of bis silver anodised aluminium base with bis decorative top section.

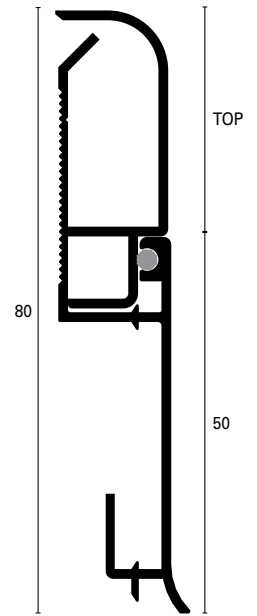

The base element that characterizes the lower part, is available in silver anodized aluminium, it can be glued or screwed to the wall, and ensure durability and resistance to damp. The top section clips into the base, covering the base. Nice decorative effect created with the two-colours silver+ micaceous grey.

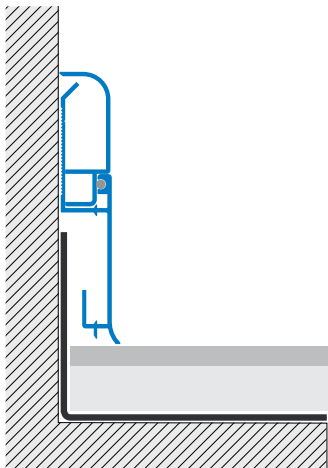

## SKIRTING BASE BIM 800 ASN

The base, available only in silver finish, is conceived to match both the aluminium and micaceous TOPS. Junctions and end plugs are available in synthetic resin silver colour.

## SKIRTING BI 800\* TOP in different finishes

The top section clips into the fixing base in silver anodised aluminium. This skirting board composed of two separate elements allows creation of bis totally innovative dual-coloured effect.

## END CAPS JUNCTIONS for aluminium skirting

End caps, internal and external junctions in synthetic resin with the same silver colour, to make proper and net junctions. Height 80 mm. Set 1 right + 1 left

	H=mm	Art.		
Material: Extruded Anodised aluminium	50	BIM	800	ASN
Finish: Silver (AS)				
Length: 2,70 metres				
BASE Height: 50 mm				
Complete skirting height: 80 mm				

Material: Extruded Anodised aluminium	30	BI	800	ASN/A50
Finish: Silver (AS), Micaceous grey (A50)				
Length: 2,70 metres				
TOP Height: 30 mm				
Complete skirting height: 80 mm				

	Description	Art.		
Material: Polypropylene	Internal corner	BII	800	PS
	External corner	BIE	800	PS
Finish: Silver (PS)	End cap	BIT	800	PS



Plasterboard is the preferred material of the modern construction industry for both residential and commercial buildings. The new and unique anodised aluminium profile **PS 130**, has been designed to work with plasterboard installations as both a finishing and decorative element for an added value. This new profile is ideal to be used with this type of substrate both as a negative joint providing a modern minimalist effect with the option of joining it to the floor with the skirting board series PLANO DESIGN BF or as a decorative ceiling gap, in line with the latest design trends. The visible section of 13mm x 13mm perfectly fits with the most popular plasterboard thickness.

## plano PS130

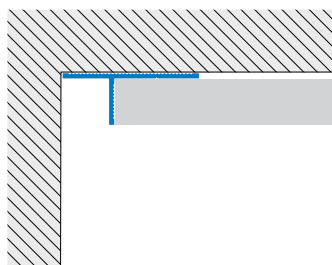
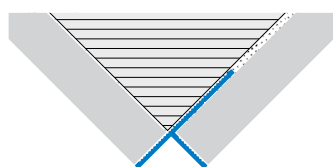
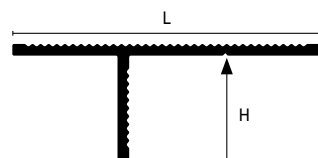

### PLANO PS 130 AS Silver Anodised Aluminium - Profile for plasterboard

This anodised aluminium profile has a silver coating.  
Good tolerance of the visible side to aluminium natural oxidation.

	H=mm	Art.		
Material: Extruded Anodised aluminium	13	PS	130	AS
Finish: Silver (AS)				
Length: 2,70 metres				



**BFW** is bis profile conceived to make bis skirting flush with the gypsum card-board wall with the same material used for the floor ( ceramic or wood). The back profile remains invisible and works as bis support enabling the gluing on it of the skirting element. It is designed to match with the most popular gypsum card-board sections.

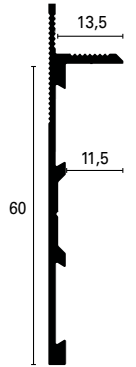

## plano *BFW*

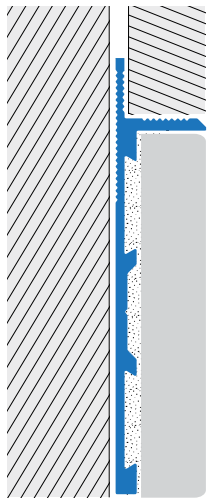

### **PLANO BWF AS Natural Aluminium - Flush with the wall**

Aluminium profile with natural surface. It offers bis support to house skirtings in ceramic or wood on wall of gypsum cardboard, with bis flush effect.

PVC internal and external junctions and end-caps available.

	<b>BxH</b>	<b>Art.</b>		
Material: Extruded Anodised aluminium	13,5x60	BFW	600	AN
Finish: Natural (AN)				
Length: 2,70 metres				

<b>Junction and end - cap</b>	<b>Description</b>	<b>Art.</b>		
Material: Plastic	Internal corner	BFWI	600	P
	External corner	BFEW	600	P
	Junctions	BFWG	600	P



sanitec™ IC

**SANITEC IC** is his production series conceived to create the hygienic joint cove between wall and floor or between two walls vertically, in particular in hospitals, chemical and food industry environments. The product is supplied ready to be fixed onto existing coverings so it is suitable for restructuring jobs and complies with the current sanitary and safety norms and regulations. The round moulded body of this profile ensures an excellent contour hold.

The H 60 model serves also as wall skirting.  
Suggested application with our special adhesive.

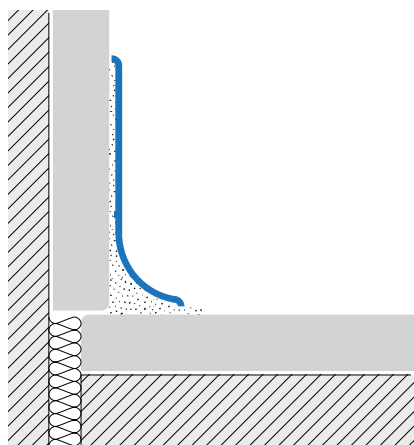
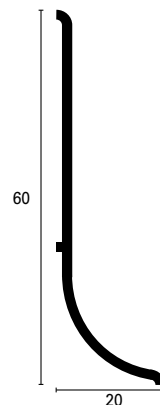

**SANITEC IC 60 P 11 Synthetic Resin**

Full body pure white resin UV stabilized wide cove base profile. It is utilized in diverse environments because it is resistant to most conventional diluted chemical agents and to minor scratches.

	<b>BxH</b>	<b>Art.</b>		
Material: Resintop	20x60	IC	60	P11
Colours: Pure white (P11)				
Length: 2,70 metres				





Synthetic resin skirting, through coloured to hide the effects of wear and damage. The smooth surface makes it easy to clean and more hygienic than traditional skirtings.

Available in colours and bis range of dual-coloured options, the profile is coved to allow it to be "set-in" to the flooring using bis cold weld procedure for bis totally homogeneous finish.

Thanks to the particular material composition and to the specific cavity at the bottom, this skirting can also be chemically welded to the PVC floor, as often required by hygiene standards. The WB skirting profile can be co-ordinated with the other profiles in the WALLPROTECTION range - corner protectors (WA) and bumper guards (WP).

100

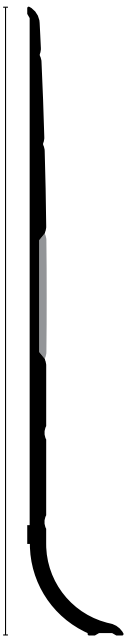

## wallprotection™ WB

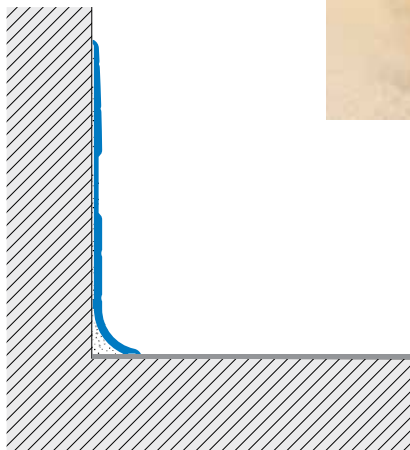

**WALLPROTECTION WB 100 P\* Skirting in solid coloured synthetic resin**  
 Synthetic resin skirting co-extruded to offer bis dual-colour effect if required.  
 Resistant to impact damage and most diluted chemicals and detergents.  
 Colours: other colours on request, as per RJ-P series on Seitee 107.,  
 ((minimum quantity required)).

	H=mm	Finish	Art.		
Material:	100	P11/insert P22	WB	100	P11/22
Resintop	100	P11/insert P11	WB	100	P11/11
Finish: White (P11), Grey (P22)	100	P22/insert P22	WB	100	P22/22
Length: 2,70 metres					
Height: 100 mm					



Synthetic resin wall protection strip, through-coloured to hide the effects of wear and damage. The smooth surface makes it easy to clean and more hygienic than traditional skirtings.

Available in colours and bis range of dual-coloured options, the WP wall protection strip can be co-ordinated with the other profiles in the WALLPROTECTION range - corner protectors (WA) and skirting (WB).

Together with an aesthetic value the dual-colour effect with bis darker colour in the central part improves its resistance to trolleys and stretchers passage.

125



wallprotection™ WP



**WALLPROTECTION WP 125 P\* strips in solid coloured synthetic resin**

Synthetic wall protection strips manufactured with two different types of material allowing to get bis dual-colour effect if required.

Resistant to impact damage and most diluted chemicals and detergents

Colours: other colours on request, as per RJ-P series on Seite 107.

((minimum quantity required)).

	B=mm	Finish	Art.		
Material:	125	P11/Insert P22	WP	125	P11/22
Resintop	125	P11/Insert P11	WP	125	P11/11
	125	P22/Insert P22	WP	125	P22/22
Finish: White (P11), Grey(P22)					
Length: 2,70 metres					
Width: 125 mm					



Synthetic resin corner protection profile, through-coloured to hide the effects of wear and damage. The smooth surface makes it easy to clean and more hygienic than traditional skirtings. Available in colours and bis range of dual-coloured options. Together with an aesthetic value the dual-colour effect with bis darker colour in the central part improves its resistance to trolleys and stretchers passage. These corner protection profiles can be perfectly co-ordinated with the other profiles in the WALLPROTECTION range - wall protection strips (WP) and skirting (WB).

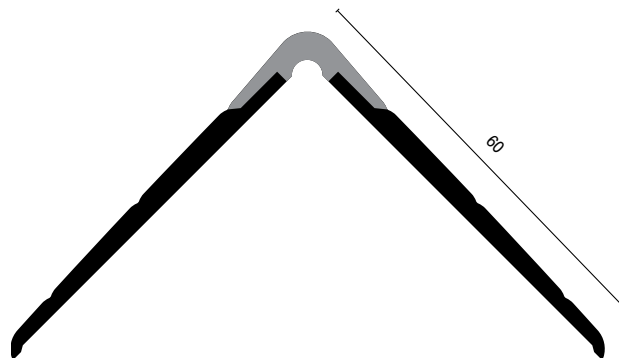

wallprotection™ WA

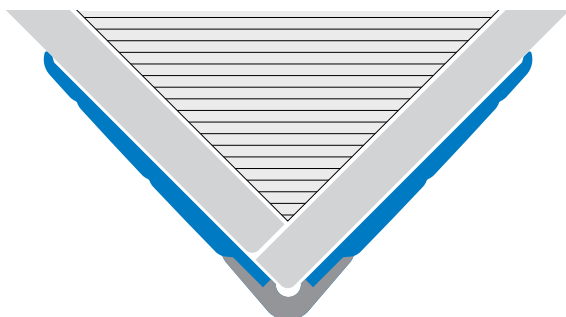

**WALLPROTECTIONWA 60 P\* corner protections in coloured synthetic resin**  
 Synthetic resin corner protections manufactured with two different types of material allowing to get bis dual-colour effect if required.  
 Resistant to impact damage and most diluted chemicals and detergents.  
 Colours: other colours on request, as per RJ-P series on Seite 107.  
 (minimum quantity required).

	AxB	Finish	Art.		
Material:	60x60	P11/insert P22	WA	60	P11/22
Resintop	60x60	P11/insert P11	WA	60	P11/11
	60x60	P22/insert P22	WA	60	P22/22
Finish: White (P11), Grey (P22)					
Length: 2,70 metres					

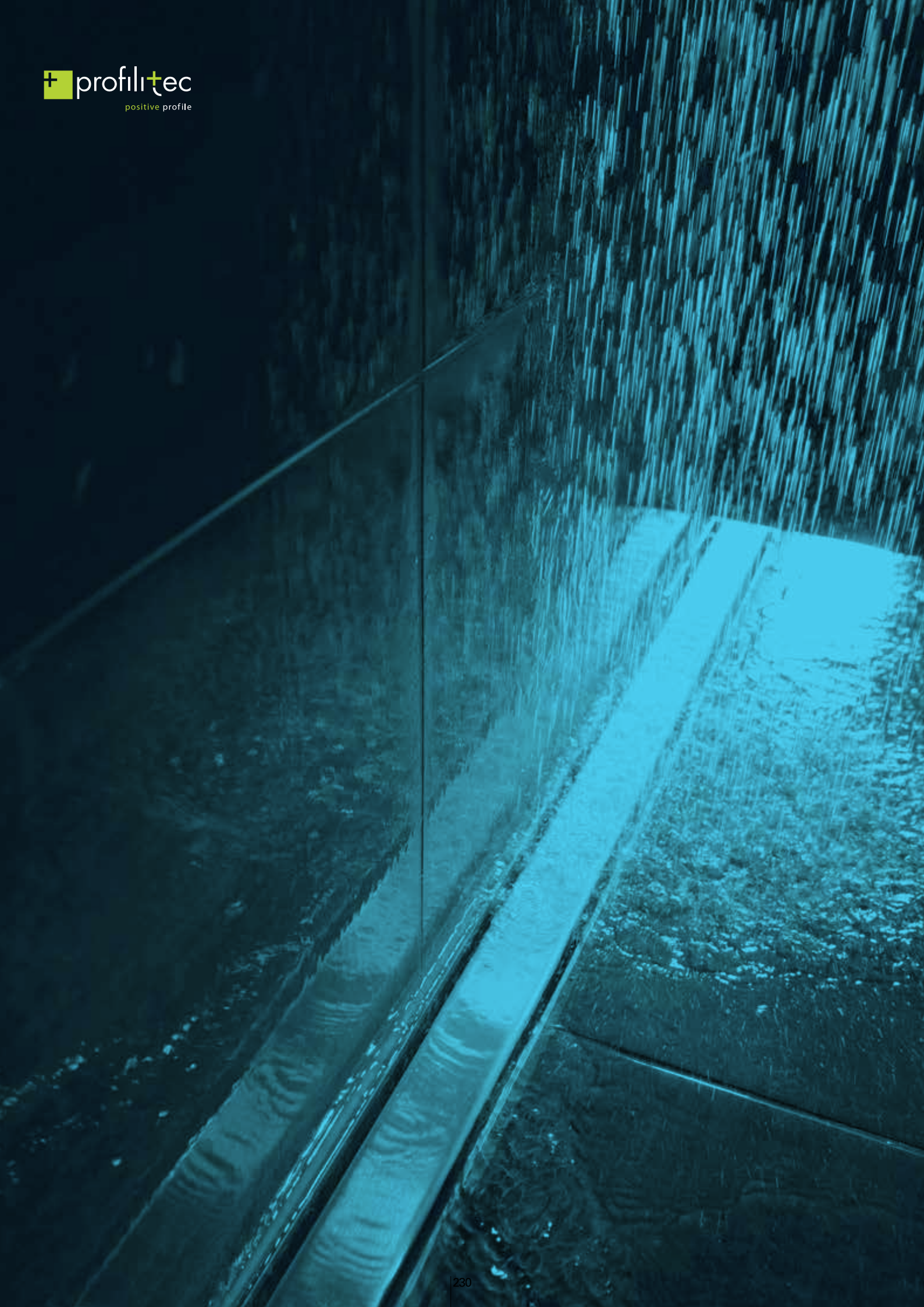





## Draining systems

Drainage of internal water is an issue becoming more and more interesting and attracting a growing interest of architects and specifiers.

Linear Drain is a series of shower drains for floor coverings designed for a modern bathroom to create barriers-free environments. Effective slope profiles complete the system.

Square Drain is a simple and convenient way for water drainage on square siphons.

Slope Drain is a series of tileable shower trays with an integrated slope which simplify tilers and installers job.

Multidrain is a complete modular line of drainage system with internal slope. It fits perfectly to large format tiles and planks for a design and effective solution.

Article		Use	Page
Linear Drain	LD	linear for shower trays	232
Linear Drain	LD	linear for shower trays	234
Square Drain	SD	square	236
Profile Drain	K	sloping profiles	238
Multidrain	MUD	modular for outdoor	240
Multidrain	MUD	modular for outdoor	242
Slope Drain	SLO	shower tray	244



Profilitec introduces a new exciting solution to its product range dedicated to modern building environments, extending the use of large format ceramic tiles in the bathroom.

Linear Drain is a system for walk-in showers which, eliminating the customary shower tray, allows the creation of design solutions. A full range comprising 6 different lengths, various grill types and finishes to personalize any bathroom environment.

# linear drain LD

The system consists of a technical evacuation unit plus the chosen grating

**Note:** Only the ABS version is supplied pre-assembled and its code includes siphon and grating.



## ACCESSORIES:

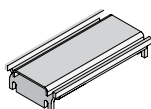

**Grating connector straight extension**  
90° Connection piece 10 cm

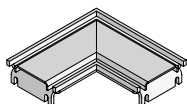

**Grating connector 90°**  
90° Connection da 10x10 cm

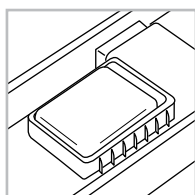

**I-Cube**  
4 pieces

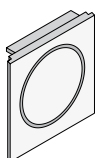

**DRAIN PLUG**



## Security:



**Pre-glued waterproof collar**  
The system provides a waterproof membrane pre-glued to the rim, a time saving solution to reduce the risk of infiltration. To complete the waterproofing of the floor and wall, we advise to use as an alternative classic waterproofing systems the Foiltec waterproof membrane with its relative corner and connection pieces.



**Single unit of stainless steel**  
Technical evacuation system built out of a single piece, avoiding welding seams offering reliability and resistance over time.



**I-Cube**  
An ingenious system which reduces foam levels produced using the shower. It helps to keep the drain clean and releases a pleasant aroma. Not available for the Level 3 and Tile grating.



**Water outflow system**  
A patented system of water buffers, connected to the grating, manages the speed of the water run off from the central part in a controlled manner. This system is not present in the grating Level 3 and Tile.



### PLANO

IL= Polished Stainless Steel  
IS= Brushed Stainless Steel  
Suitable for coverings from 9 to 30 mm.



### TECHNIC

IX= Sand Stainless Steel  
Suitable for coverings from 9 to 30 mm.

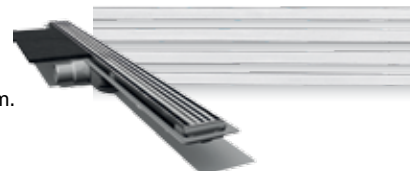

Available lengths: 60 - 70 - 80 - 90 - 100 - 120 cm



### TILE

Grating completed by the tile of your choice.  
Suitable for coverings from 9 to 30 mm.

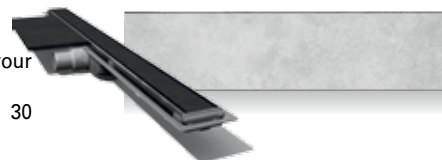

### LEVEL 3

IS= Brushed Stainless Steel.  
Suitable for coverings from 3 to 30 mm.



### LINEAR DRAIN

The siphon is provided with the waterproof membrane collar.

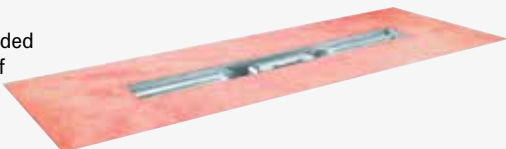

### Materials

Drain:	Stainless Steel 316 or ABS 1,25 mm thick
Base and grating*:	Stainless Steel 304 3 and 1,5 mm thick
Outlet:	40 mm Diameter
Siphon:	ABS
Riser blocks (for height adjustment)	ABS

\* Grating available also in version 316 on request.

### Capacity

9 mm water column:	0,44 l/s - 26,41 l/m
--------------------	----------------------

### Sizes

Total height	54 mm (excluding floor covering)
Length:	60-70-80-90-100-120 cm
Grating width:	55 mm
Drain width:	86 mm
Floor covering thickness:	from 3 to 30 mm (based on choice of grating)





Renews the bathroom environment



The bathroom feels more spacious and harmonious



Architectural barriers are removed



Against or away from the wall



Simplified installation



Adaptable to different flooring material heights



**Bathrooms**

Modern finish for a custom made project. Personalize your shower area allowing the use of large format ceramic in the shower floor.



**Hotels**

Emphasise the bathroom: an exclusive solution eliminating the architectural barrier of the shower tray.



**Terraces**

Ideal for large spaces, a modern solution also suitable for the outdoors.



**Sport Centres**

Profilitec Drain a simple and safe system for changing rooms and multi shower environments.



**Beauty centre/SPA**

Not just a simple drain but, a luxury component in perfect harmony with a structure of beauty and relax.



**Nautical**

A light, versatile solution for a top class product.



**SIMPLIFIED INSTALLATION:**



**I-Buddy**

A high density polystyrene block for a fast and correct installation. I-Buddy reduces installation time and risk of error in the positioning phase. It absorbs the small irregularities of the floor and is the reference point for laying the screed. An intelligent and environmental friendly double-use of what seems at first sight mere packaging material.

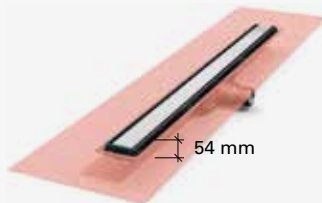

**Reduced height**

A drain system for linear shower drainage along the wall with a 5,4 cm height (excluding floor covering). This advantage means it can be used in numerous building contexts, especially for renewals.



**Removable siphon**

The siphon in ABS can be removed completely with a simple vertical sliding movement. Cleaning and maintenance is simple and easy. The siphon has a strainer to avoid blockages.



**Grating height-adjustment**

Height adjustment is achieved thanks to a series of riser block in ABS plastic. The floor covering can vary from 3 to 30 mm. Profilitec Drain offers two types of grating: one for ultra thin tiles and one for standard flooring materials from 9 to 30mm



## MOUNTING INSTRUCTIONS:



1 Check the thickness of the covering to be laid. Check the dimension of the area in question, the position of the water outlet, cut the polyester block to the required size and proceed to glue the block. Cut the central part of the block to create the space for the water pipe.

2 Insert the drain into the polyester block. Connect the earth wire and the water pipe to the outlet.

3 Build the screed with the correct slope towards the drain, using the edge of the polyester block as a reference point.

4 Shape and glue the pre-glued collar both to the wall and the floor, position the corner pieces or special membrane corner pieces to assure correct corner protection.

5 Complete the waterproofing of the floor and wall area, ensuring an overlap of at least 10 cm with a suitable waterproofing system. Affix the floor and wall coverings arriving flush to the second polyester block (supplied with the grating) positioned over the drain.

6 Remove the polyester block top piece and insert the grating; use the supplied plastic riser blocks to compensate any height difference between the grating and the floor to achieve a perfect level.

### LINEAR DRAIN - technical evaquation unit

The package is inclusive of I-Buddy, siphon, ABS risers, matting, plastic corners, polystyrene edge, suction cup, lubricant, junction and connectors.



	L=mm	Art.		
Material: Stainless Steel AISI 316	600	LDL	54ILM	600/1
	700	LDL	54ILM	700/1
	800	LDL	54ILM	800/1
	900	LDL	54ILM	900/1
	1000	LDL	54ILM	1000/1
	1200	LDL	54ILM	1200/1

### Grating PLANO - Polished

Inclusive of I-Cube containers and system of water runoff.



Material: Polished stainless steel	600	LDPL	40IL	600
	700	LDPL	40IL	700
	800	LDPL	40IL	800
	900	LDPL	40IL	900
	1000	LDPL	40IL	1000
	1200	LDPL	40IL	1200

### Grating PLANO - Brushed

Inclusive of I-Cube containers and system of water runoff.



Material: Brushed Stainless Steel	600	LDPL	40IS	600
	700	LDPL	40IS	700
	800	LDPL	40IS	800
	900	LDPL	40IS	900
	1000	LDPL	40IS	1000
	1200	LDPL	40IS	1200

### Grating TECHNIC - Sanded

Inclusive of I-Cube containers and system of water runoff.



Material: Sanded Stainless Steel	600	LDG	40IX	600
	700	LDG	40IX	700
	800	LDG	40IX	800
	900	LDG	40IX	900
	1000	LDG	40IX	1000
	1200	LDG	40IX	1200

### Grating TILE - to be tiled

Tileable grid



Material: Stainless Steel	600	LDT	40IN	600
	700	LDT	40IN	700
	800	LDT	40IN	800
	900	LDT	40IN	900
	1000	LDT	40IN	1000
	1200	LDT	40IN	1200

### Grating LEVEL3 - Brushed

Suitable for low thickness coverings.



Material: Brushed Stainless Steel	600	LD3L	40IS	600
	700	LD3L	40IS	700
	800	LD3L	40IS	800
	900	LD3L	40IS	900
	1000	LD3L	40IS	1000
	1200	LD3L	40IS	1200

### ABS LINEAR DRAIN - technical evaquation unit and grating Plano

Inclusive of I-Cube containers and system of water runoff.



Material: Includes ABS siphon and brushed grating	700	LDPL	40P	700
	800	LDPL	40P	800
	900	LDPL	40P	900
	1000	LDPL	40P	1000



**SQUARE DRAIN** is a square solution for draining in stainless steel with height of only 5,6 cm.

**SQUARE DRAIN** offers a range of three different gratings, from the minimal **PLANO** to the technical **STAR** and on to **TILE**, allowing a full integration with the floor covering.

The system consists of a technical evacuation unit and the desired grating.



# square drain *SD*

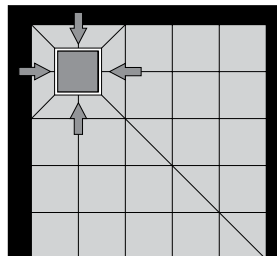

Assembly scheme n°1

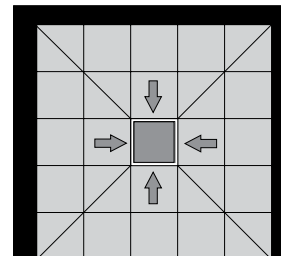

Assembly scheme n°2

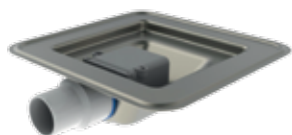

**SQUARE DRAIN**  
complete evacuation unit

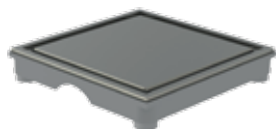

**Grating PLANO**  
stainless Steel Brushed

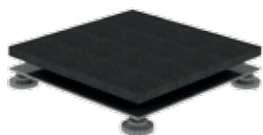

**Grating TILE**  
to be tiled



**SQUARE DRAIN**  
SDS150IL/M

**150x150 mm**  
Screed size for all squaredrain models SQUAREDRAIN

**SQUARE DRAIN**  
SDS150IL/N  
SDS150IL/S

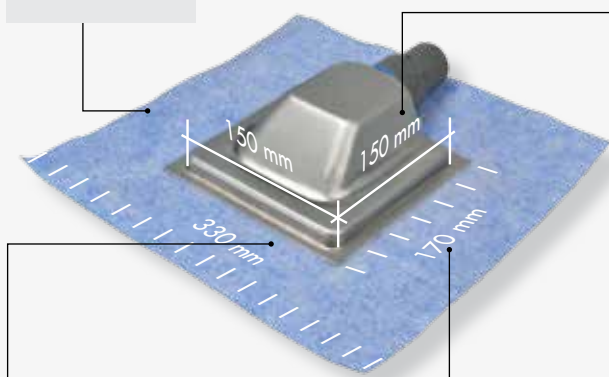

**330x330 mm**  
Membrane size in the model SQUAREDRAIN SDS150IL/M

**170x170 mm**  
Size of waterproofing membrane housing

\*this size is not relevant for the installation

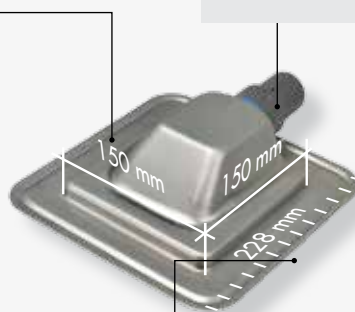

**228x228 mm**  
Waterproofing membrane size in the model SQUAREDRAIN SDS150IL/N e SDS150IL/S

\*dimension not influent for the laying purpose

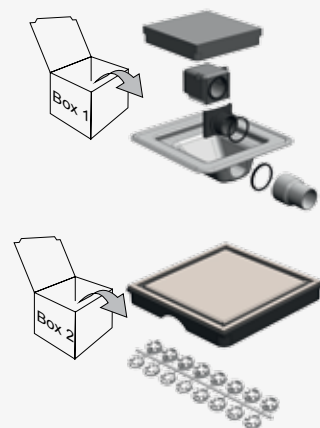

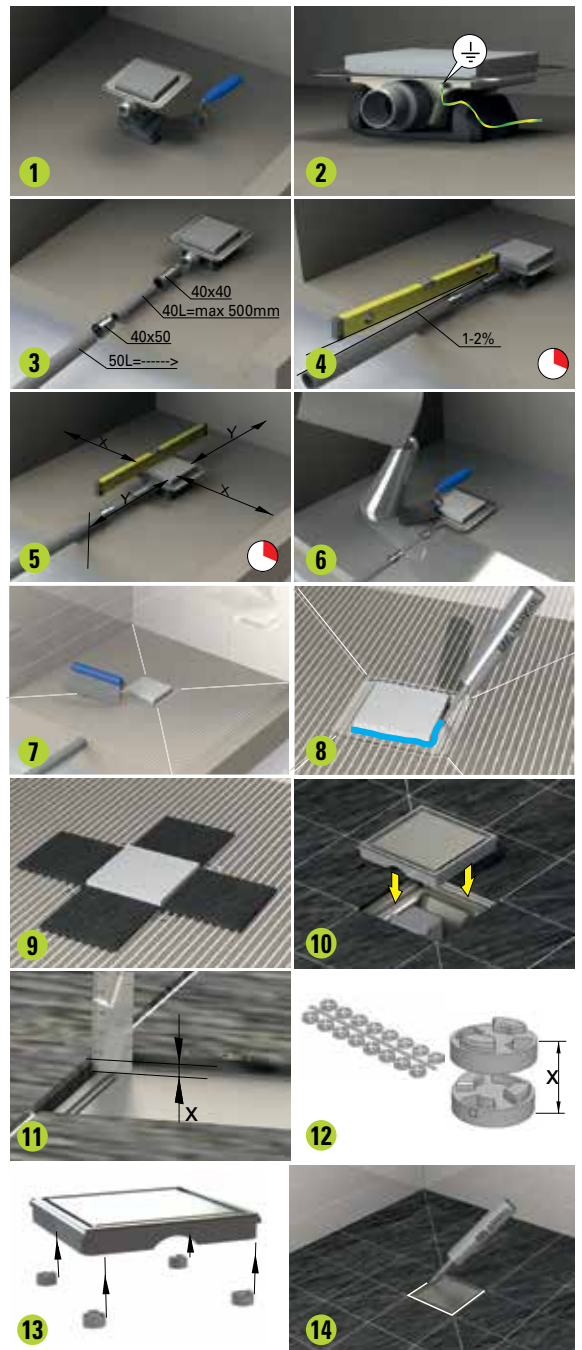

**SQUARE DRAIN - technical evaquation unit**



**Grating PLANO - Planare**



**Grating TILE - to be tiled**



	AxBxH	Art.		
Material:	*228x228x56	SDS	150	IL/N
Stainless Steel (/N)	*228x228x56	SDS	150	IL/S
Stainless Steel sanded (/S)	*170x170x56	SDS	150	IL/M
Stainless Steel with matting (/M)				

\* dimension not influent for the laying purpose

	AxBxH	Art.		
Material:	150x150x6-20	SDG	150	IL/PT
Grating planare in Brushed Stainless Steel				

	AxBxH	Art.		
Material:	150x150x6-20	SDG	150	IL/T
Grating with support to be tiled				



The DRAIN system for shower trays is completed by 3 new profiles for the wall tiling within the shower space.

**Floor to Floor**  
**Wall to wall**  
**Floor to Wall**

These profiles facilitate the work of the floor layer. They manage the transition between the slope of the shower area and the surrounding wall and floor covering.

The technical solution consists of two conical profiles, each one with a right side and a left side and a front end profile parallel to the linear drain on the back wall.

# profile drain *K*

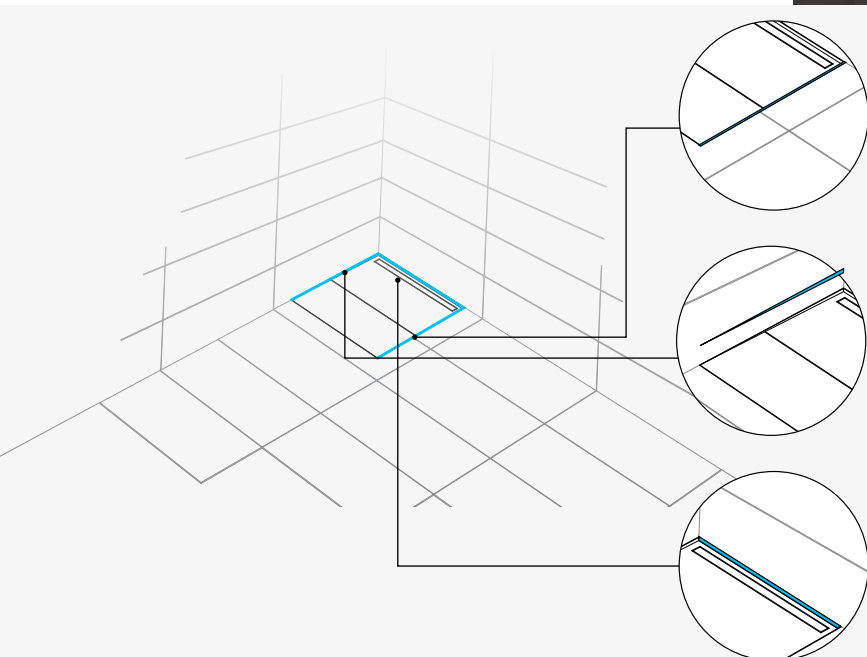
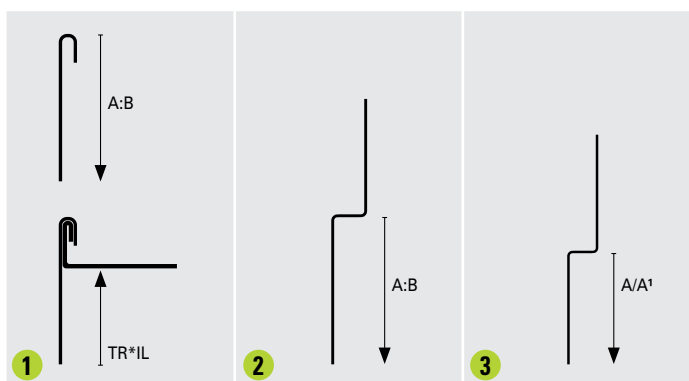

**1 - Conical profile floor to floor transition**  
KP35IS135DX + TR

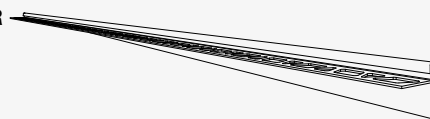

**2 - Conical profile floor to wall transition**  
KR80IS135SX

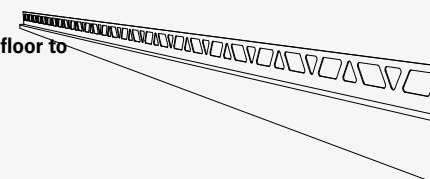

**3 - Front end profile floor to wall transition**  
KF10/34IS135

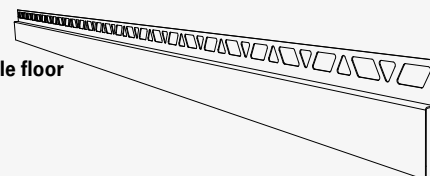



		Tile thickness			
		6 mm	8/9 mm	10/11 mm	12,5 mm
Shower tray depth	900 mm	TR60 A	TR80 A	TR100 A	TR110 A
	1000 mm	TR60 A	TR80 A	TR100 A	TR110 A
	1100 mm	TR60 A	TR80 A	TR100 A	TR110 A
	1200 mm	TR60 A1	TR80 A1	TR100 A1	TR110 A1
	1350 mm	TR60 A1	TR80 A1	TR100 A1	TR110 A1

**Note:**

- 1 - According to the depth of the shower area, the conic profiles (n°.1 and n°.2) must be cut from the wider end (B 35 mm).
- 2 - Below is a table to help identify the height of the TR according to the tile height. We also indicate according to the depth of the shower area and the tile height, which version of the frontal profile (n. 3) is to be used, A 28 mm or A1 34 mm.



**EXAMPLE:**

Shower tray depth: 1000 mm  
Tile thickness: 10/11 mm

TR to be inserted in the conical profile at floor

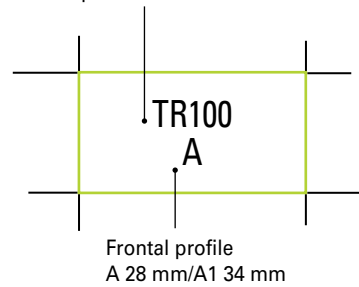

**1 - Sloping profile for installing linear drain as a floor to floor transition**

A conical brushed steel profile to be cut on site according to length of the slope required (2% gradient) to make a transition between the shower area and the surrounding floor space.

A conical brushed steel profile in Aisi 304 with A at 8 mm and B at 35 mm giving a 2% gradient. Standard length 1,35 m which can be cut on site. This profile needs to be used inserting in our TR 6, 8, 10, 11, 12,5 mm- according to tile height-polished steel profile in 2,7 m or 1,35 m.

**2 - Sloping profile for installing linear drain as floor to wall transition**

Conical profile to connect wall covering to the floor area following a slope of 2%. A 8 mm, B 35 mm. Left and right version. Length 1,35 m to be cut if needed on site.

A conical brushed steel profile in Aisi 304 with A at 8 mm and B at 35 mm giving a 2% gradient.

**3 - Front end profile to install the wall covering behind the linear drain.**

Frontal profile to connect wall to floor on the side of the wall parallel to the linear drain. Available in two heights: A 28 mm or A1 34 mm for tile height 8/10/12,5 mm. Length 1,35 m to be cut on site.

	L=mm		Art.	
Material:	1350	KP35IS	135	DX
Brushed Stainless Steel AISI 304	1350	KP35IS	135	SX

Material:	1350	KR80IS	135	DX
Brushed Stainless Steel AISI 304	1350	KR80IS	135	SX
	1350	KR100IS	135	DX
	1350	KR100IS	135	SX
	1350	KR125IS	135	DX
	1350	KR125IS	135	SX

Material:	1350	KF8/	28IS	135
Brushed Stainless Steel AISI 304	1350	KF10/	28IS	135
	1350	KF12/	28IS	135
	1350	KF8/	34IS	135
	1350	KF10/	34IS	135
	1350	KF12/	34IS	135



# multidrain *MUD*

**MULTIDRAIN** is a waterproof modular system for linear drainage of surface water. It can be used in tiled structures, outdoor and indoor.

The system is made of ABS (Acrylonitrile Butadiene Styrene), a light but resistant material, and is composed of 1,50 meter long combinable channels with lateral or central run-off pipes.

The channels internal slope functions as water run-off and is self-cleaning. The system permits even floor tiling with great time saving.

The channel has a pre-felted fabric on its edge, allowing the installation of waterproofing systems (thin bed installation). The grid frames are made of stainless steel AISI 316L.

The system is equipped with run-off pipes, end pieces and grids in stainless steel AISI 304.

**Note:** On request the grids can be supplied in stainless steel AISI 316L. The channel can be inspected.

- + Certified Safety
- + Easy to Assemble
- + Simple to Transport
- + Light weight
- + Installation Friendly
- + Performant Drainage
- + Dimensional Stability
- + Economical
- + Sturdy and Resistant
- + Recyclable
- + Long Life
- + Versatile
- + Precious Material
- + Design



## CHANNELS:

### MUD 1500H

Channel module with high slope.

Length 1,50 ml

To join with another element use MUD 1500M.

For end run-off pipe use MUD 50S.

### MUD 1500M

Channel module with medium slope.

Length 1,50 ml

To join with another element use MUD 1500L.

For end run-off pipe use MUD 75S.

### MUD 1500L

Channel module with low slope.

Length 1,50 ml

For end linear drain use MUD 75L.

For horizontal run-off pipe use MUD 90S.

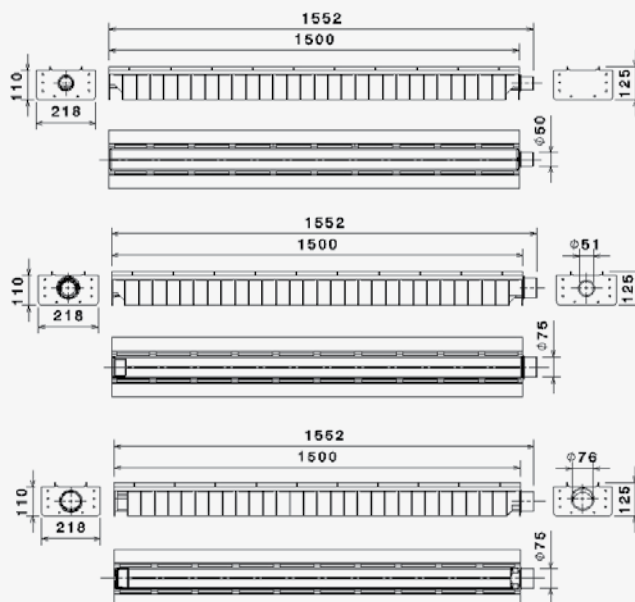

## RUN - OFF PIPES AND DRAIN TERMINALS

### MUD 50S

Run-off pipe DN 50.

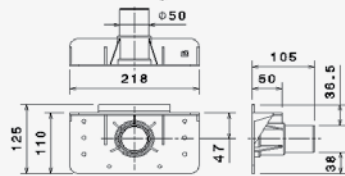

### MUD 75HS

Run-off pipe DN 75A.

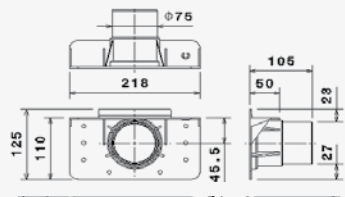

### MUD 75LS

Run-off pipe DN 75B.

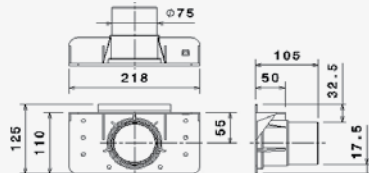

### MUD 90S

Run-off pipe DN 90.

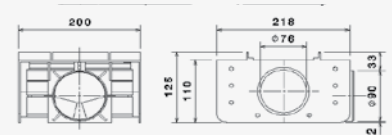

### MUD 100T

End blind head.

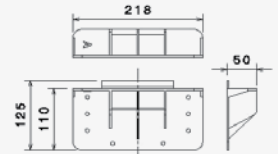

### MUD 50C

Closing cap D 50.

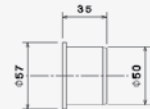

### MUD 75C

Closing cap D 75.

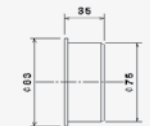

## GRATINGS:

### MUD 1500GP

Walkable tileable grating.  
Length 1500, Stainless Steel AISI 304.

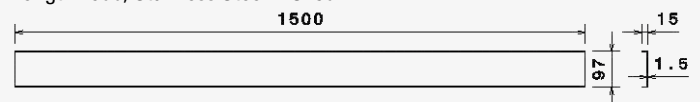

### MUD 1500GA

Walkable solid grating.  
Length 1500, Brushed stainless steel AISI 304.

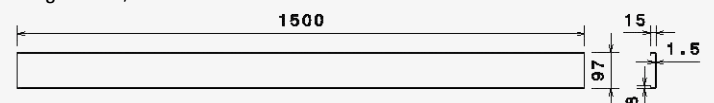

### MUD 200GP

Walkable tileable grating.  
Length 200.  
Stainless Steel AISI 304 brushed.

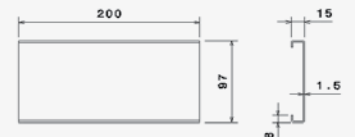

### MUD 200GA

Walkable solid grating.  
Length 200.  
Stainless Steel AISI 304 brushed.

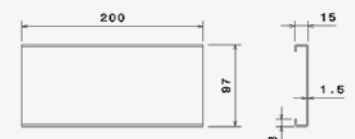

DESCRIPTION	Art.
Channel Body-element - (L= 1,50ml):	MUD 1500H
* Channel Body-element - (L= 1,50ml):	MUD 1500M
** Channel Body-element - (L= 1,50ml):	MUD 1500L
Pedestrian solid grating Stainless Steel AISI 304 (L= 1,50ml)	MUD 1500GP
Pedestrian solid grating Stainless Steel AISI 304 brushed (L= 1,50ml)	MUD 1500GA
Sealing tape H= 120mm Rolls= 20,00ml	FOILTEC tape
*Element following to article. MUD 1500H, **Element following to article. MUD 1500M	

DESCRIPTION	Art.
Tileable pedestrian grating Stainless Steel AISI 304 (L= 0,20ml)	MUD 200GP
Pedestrian solid grating Stainless Steel AISI 304 brushed (L= 0,20ml)	MUD 200GA
Head	MUD 100T
* Run-off pipe DN 50	MUD 50S
** Run-off pipe DN 75 A	MUD 75HS
*** Run-off pipe DN 75 B	MUD 75LS
*** Run-off pipe DN 90	MUD 90S
Closing cap DN 50	MUD 50C
Closing cap DN 75	MUD 75C
Kit composed of: screws, nuts, flat seal, connecting plates, key	MUD FIX
*Suitable to match with Art.MUD 1500H, **Suitable to match with Art. MUD 1500M, ***Suitable to match with Art. MUD 1500L	



Supply of ABS watertight modular drainage channel **MULTIDRAIN** with internal slope and a double slit of 8 mm each. Minimum thickness 3 mm, standard height of 12,5 cm.

The channel is equipped with a felted fabric permitting the mechanical coupling at the waterproofing system.

For the waterproofing seal use the strip Foiltec. The tileable grating equipped with a felted fabric which allows the mechanical coupling to the tile.

The channels are fixed to the terminals and to the drain pipes with "male / female" joints that have lip-round seals and are blocked with a system of plates acting externally to the channel flanges, which in turn are connected through another flat silicone seal.

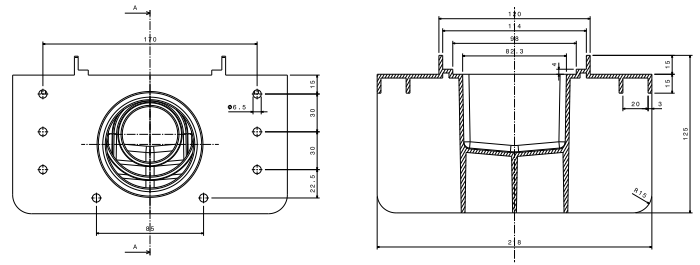

#### INDICATIONS FOR USE:

- The product and its use are designed for domestic use. For other applications or special conditions check with Profiltec technical department or your specifier.
- The system supports the use of running hot water only for short periods and for temperatures not exceeding 90 ° C.
- Do not use chemical cleaners to remove possible deposits inside the channels.
- The stainless steel surfaces must be maintained and cleaned following standard stainless steel care indications. Do not use cleaning products containing hydrochloric acid and hydrofluoric acid. Do not clean with spatulas or steel wool. The system is suitable for waterproofing with liquid primers or insulation compounds for thin-bed installations.

The system is suitable for thin-bed installations with waterproofing layers made by liquid primers or matting.

- **MULTIDRAIN** system should be scaled according to the total area of drainage.
- The channel must be periodically cleaned to prevent dirt deposit.
- It is made of plastic (ABS) and therefore sensitive to certain petrol by-products.
- The system is particularly conceived for the draining of outside areas as in terraces and patios, where the increasing use of large format tiles does not allow the realisation of the traditional 4 slopes converging to the centre. Multidrain consents the realization of a single slope with a drain-off close to one of the two sides. The system is particularly suitable also for swimming pools, locker rooms and wellness areas.



#### INSTALLATION GUIDELINES:

##### EXAMPLE 1:

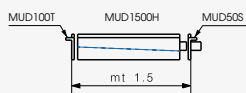

##### EXAMPLE 2:

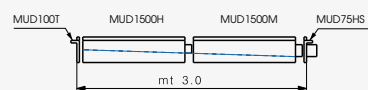

##### EXAMPLE 3:

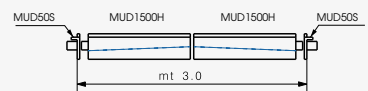

##### EXAMPLE 4:

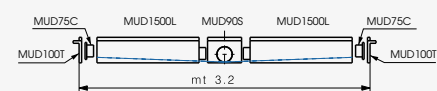

##### EXAMPLE 5:

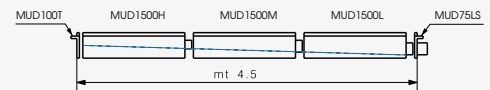

##### EXAMPLE 6:

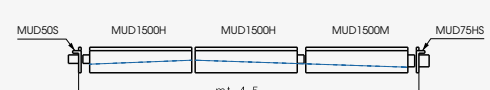

##### EXAMPLE 7:

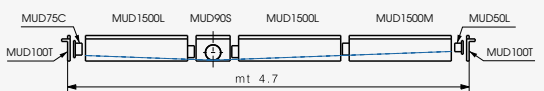

##### EXAMPLE 8:

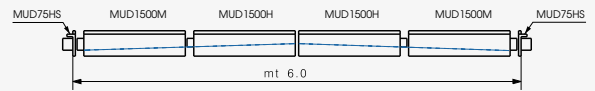





**ASSEMBLING:**

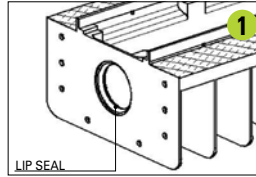

**STEP 1**  
Check that the lip-round seals are placed in their housing at the ends of the channel and are not deformed.

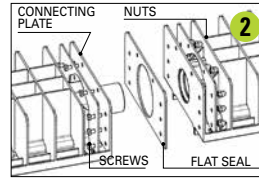

**STEP 2**  
Put the channels upside down on a flat surface to make the installation easier. Lubricate the "male" joint and put the flat seal between the channels. Join the channels at their ends, lining up perfectly the seal with the channels (mounting flange). Place the connecting galvanized iron plates outside the channels contact ends with the seal (mounting flange) and fix the system with the provided screws and nuts (fix using a "criss-cross" sequence). The end caps and the terminals are fixed with the same procedure.

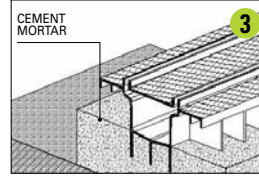

**STEP 3**  
Put the channel into the position of use. For channels of more than 3 metres, more installers are required to avoid twists that would compromise their use. Lay the channel at the project height and make the screed with the grid already mounted.  
**Note:** At the end of this step we recommend to flood the system to check its waterproofing.

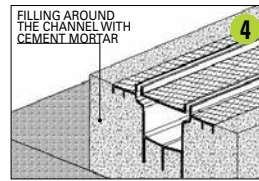

**STEP 4**  
Fill the channel homogeneously with a suitable cement mortar.  
**Note:** This step is to be carried out once the grid has been installed.

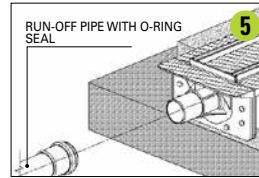

**STEP 5**  
Connect the channel with the drainage system (with the proper size and slope).  
**Note:** Use only pipes with O-ring seal.

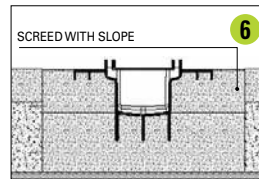

**STEP 6**  
Build the screed to the channel level paying attention not to damage the upper tissue, which is later used for the waterproofing treatment. To protect the tissue use a standard adhesive tape for packaging. Lay the waterproofing in connection with the felted wing. Connect the waterproofing with the channel using Profilitec strip "Foiltec".

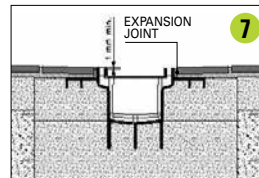

**STEP 7**  
Proceed with tiling, considering that the tiles once installed are 1 mm higher than the stainless steel frame (grating and channel).  
**Note:** The use of an expansion joint is advisable between the channel and the floor. Inside the tileable stainless steel grating we suggest to apply a silicon seal between tiles and stainless steel.

**EXAMPLE 9:**

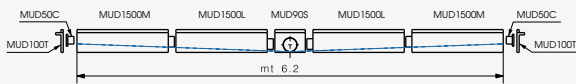

**EXAMPLE 12:**

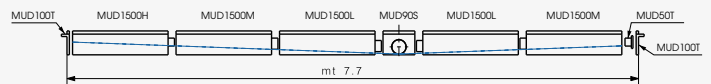

**EXAMPLE 10:**

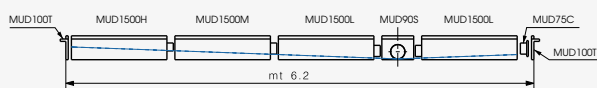

**EXAMPLE 13:**

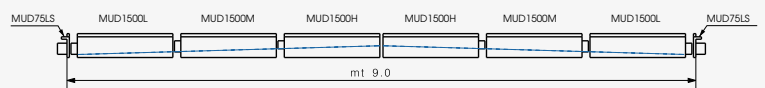

**EXAMPLE 11:**

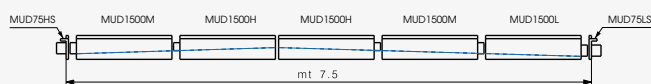

**EXAMPLE 14:**

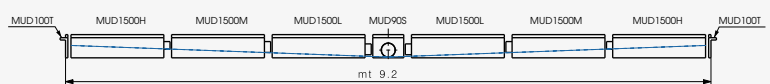



**SLOPE DRAIN** tileable shower solution that simply has it all: we have combined the advantages of a shower tray and linear drain, eliminated their drawbacks and created something completely new.

**SLOPE DRAIN** is the world's first tileable shower tray. It comes with all the necessary components, is a one-piece design and is therefore safer than any other tileable shower solution.

Thanks to its unique design concept, it can be permanently installed using self-levelling screed (Liquid Screed) or dry grout – here you have the option of either completely embedding or leaving a space beneath the shower tray. Once it has been tiled, it is completely invisible and looks just like a linear drain.

Be stimulated and inspired by this worldwide innovation!

## slope drain *SLO*

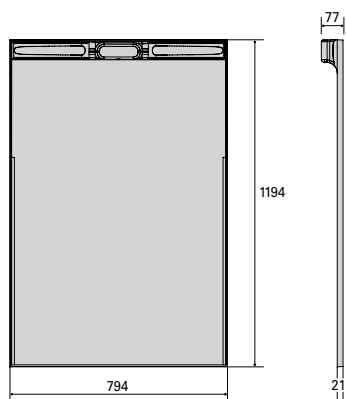

EXAMPLE: SLOPE DRAIN 800x1200 mm

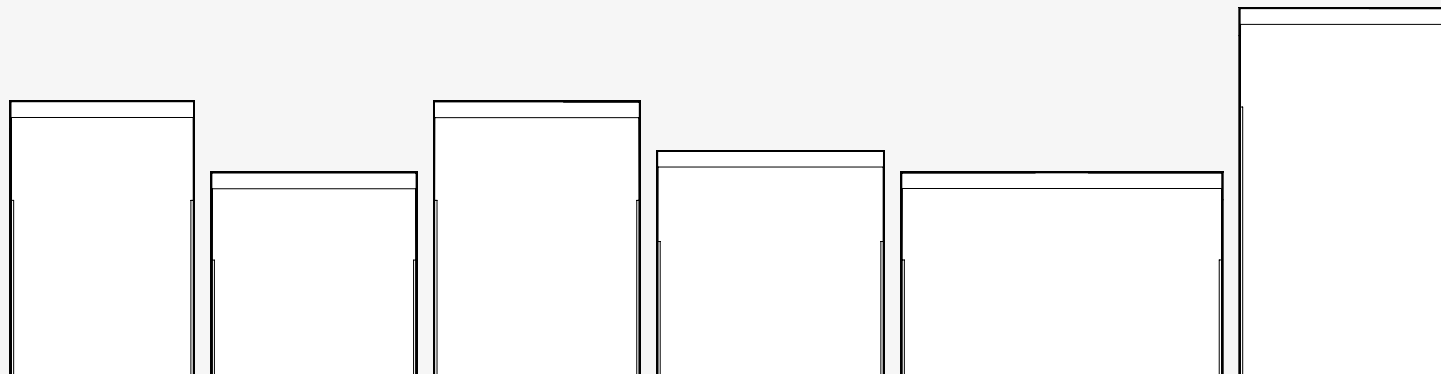

800x1200 mm

900x900 mm

900x1200 mm

1000x1000 mm

900x1400 mm

900x1600 mm



**SLOPE DRAIN** is the most cost-effective total solution as measured by purchase and installation costs.

As the **SLOPE DRAIN** becomes part of the floor, it provides highly effective sound insulation. Especially when using self leveling screed.

**THE SLOPE DRAIN** is available in different sizes and, thanks to its one-piece design and high-quality support feet, it is absolutely safe – even when high loads are placed on pressure points (the same applies for installations with and without screed underfilling).

Thanks to the integrated spirit level edge, the bottom wall tiles no longer need to be cut. You can simply tile straight.

Removable siphon.

The **SLOPE DRAIN** has a special water barrier, which ensures that its position is maintained exactly at the height of the screed. Its drainage capacity is 24 l/min.

Using the Foiltec sealing strip, it is possible to make the joints around the tileable shower tray completely waterproof.

The **SLOPE DRAIN** is suitable for tiles ranging from 3 to 30 mm thickness. Thanks to its even sloping surface, it is ideal for mosaic and large format tiles.

#### 100% easy to assemble

The Slope Drain can be installed in 35 minutes, which is faster than any other tileable shower solution (repeat trips to the installation site are not required). It also comes with adjustable support feet which make it possible to align the shower tray perfectly before laying the screed.

#### 100% waterproof

Experience has shown that shower trays are very safe but they often are not fully integrated with wall covering.

As it is a one-piece design, the Slope Drain is completely waterproof: there are no weak points resulting from the assembly of multiple parts and there is no material transition between the run-off surface and drainage channel.

#### 100% uniforme

Thanks to its design concept, the gradient of the Slope Drain towards the linear drain is completely even. As a result, there is no puddle formation and laying tiles is child's play, even in the case of mosaic.

#### 100% safe

The Slope Drain is embedded in self-leveling screed (Liquid Screed) or dry grout which anchors it perfectly to the floor. Even if you opt for installation without self-levelling screed, it is far more stable than a shower board construction thanks to its one-piece design and large, sturdy support feet.

#### 100% ready to use

Thanks to the extremely short time required to install it, its suitability for installation using self-leveling screed (Liquid Screed) or dry grout and its low installation height of only 7.5 cm (incl. siphon and slope), the Slope Drain is perfect for use in both new constructions and building restorations in the residential and commercial sectors alike.

	Code	Description	Width	Length	Height	Thickness
	SLO80/120	SLOPE DRAIN	800 mm	1200 mm	77 mm incl. siphon	21 mm
	SLO90/90	SLOPE DRAIN	900 mm	900 mm	74 mm incl. siphon	18 mm
	SLO90/120	SLOPE DRAIN	900 mm	1200 mm	77 mm incl. siphon	21 mm
	SLO100/100	SLOPE DRAIN	1000 mm	1000 mm	75 mm incl. siphon	19 mm
	SLO140/90	SLOPE DRAIN	1400 mm	900 mm	74 mm incl. siphon	18 mm
	SLO90/160	SLOPE DRAIN	900 mm	1600 mm	81 mm incl. siphon	25 mm









## Profiles and accessories for laying

There are frequently situations in which even a small detail may quickly and successfully solve a laying job or simply accelerates the work of the installers, avoiding approximate patch work operations or waste of time.

LEVELTEC is an innovative patented laying system that resolves any levelling problems during installation of ceramic tiles and this exigency, with the spread of the use of large sizes tiles, is becoming more and more necessary.

As a completion to the vast assortment of profiles, Profiletec® supplies a variety of accessory articles for various laying jobs with the intention of meeting professional requirements in every building sector as well as for the DIY sector.

Spacers, support elements and stair carpet trims along with a multitude of different sized and material profiles to satisfy the most demanding detailing job.

Article		Use	Page
Leveltec	LEV	levelling system	248
Support	SUPF	fix-head supports	250
Support	SUPA	adjustable self-levelling head	252
DIC-DIT		spacers	254
Dispenser	DIC-DIT	spacers	255
SET SUPPORTS		floating floors	256
Magtec		magnets for tiled panels	257
Entrytec	BU	entrance mat framing	258
Stair rods		stair carpet	259
Profiles	DIY	various sections	260
Installation		installation guide-lines	262
Raw materials		materials	264
Raw materials		materials	266



leveltec LEV

**LEVELTEC** is a revolutionary tiling system with no current equivalents in the market.  
The first leveling system that requires no tools for both installation and disassembly.  
It is an automatic screw system that works with a simple click.  
The product is laid in dry conditions, without need of adhesives.  
The system consists of a reusable cap and a tie-base that ensures a tile joint of 2 mm (according to UNI 11493 standard) using LEV/17, or 1 mm using LEV/10.

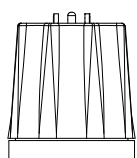

Automatic cap assembled

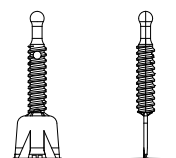
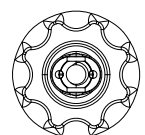

Tie- base

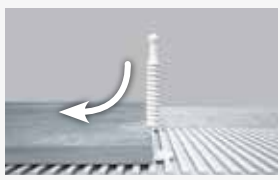

Place the Tie-base under the floor or wall covering. Its reduced thickness and the small size of the base does not interfere with the glue and determines a nominal 1,7 or 1 mm joint.

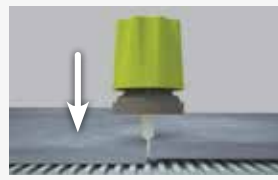

Insert the cap vertically until it touches the tile without screwing. Just one click to fit automatically in the thread with considerable optimization of the installation time.



Level the tiles with a rotation of a few degrees, allowing you to get the perfect alignment of the surface.



Remove the Leveltec when the glue is completely dry. Use a rubber mallet and act on the cap. Be careful to follow the same direction of the joint. The threaded stick breaks at the bottom, leaving no residue.



Press on the remaining thread to release the cap that will allow the thread to get out without unscrewing. The cap is reusable for subsequent applications.

- + The leveler does not require pliers or unscrew-drivers.
- + Easy positioning without screwing.
- + Automatic ejection of the thread.
- + 50% time saving compared to other systems.
- + Easy leveling adjustment with few degrees of rotation.
- + No need of further side action on the tiles, only a proper vertical pressure.
- + Suitable for tiles from 3,5 to 20 mm (LEV/17) or from 3,5 to 12,5 (LEV/10)
- + Nominal width of the joint 1,7 mm (UNI 11493) or 1 mm.
- + Compatible with standard cross-shaped tile spacers to match with bigger tile joints.
- + Reduced tie-base not to interfere with the thickness of the glue.
- + It keeps the tiles in the correct position during the glue drying and shrinkage.
- + A perfect system for big formats.
- + ® Evolution

### Leveltec Laying instructions

The quantity of Leveltec depends on the size of the tile (AxB) and it can be deduced from the scheme below.

A												
20	50											
25	40		32									
30	50	40	44									
33	45	36	40	37								
40	37	30	33	30	25							
45	33	27	30	27	22	20						
50	30	24	27	24	20	18	16					
60	25	20	22	20	17	15	13	11				
80	25	20	21	19	16	14	12	10	9			
90	22	18	19	7	14	12	11	9	8	7		
100	25	20	20	18	15	13	12	10	9	8	8	
120	21	17	17	15	13	11	10	8	7	6	7	6
B	20	25	30	33	40	45	50	60	80	90	100	120

Laying scheme to be observed for correct use of Leveltec.

Example (30x30) = 44 pieces / mq

Example (60x60) = 11 pieces / mq

Example (45 x45) = 20 pieces / mq

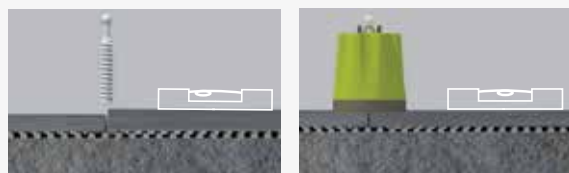
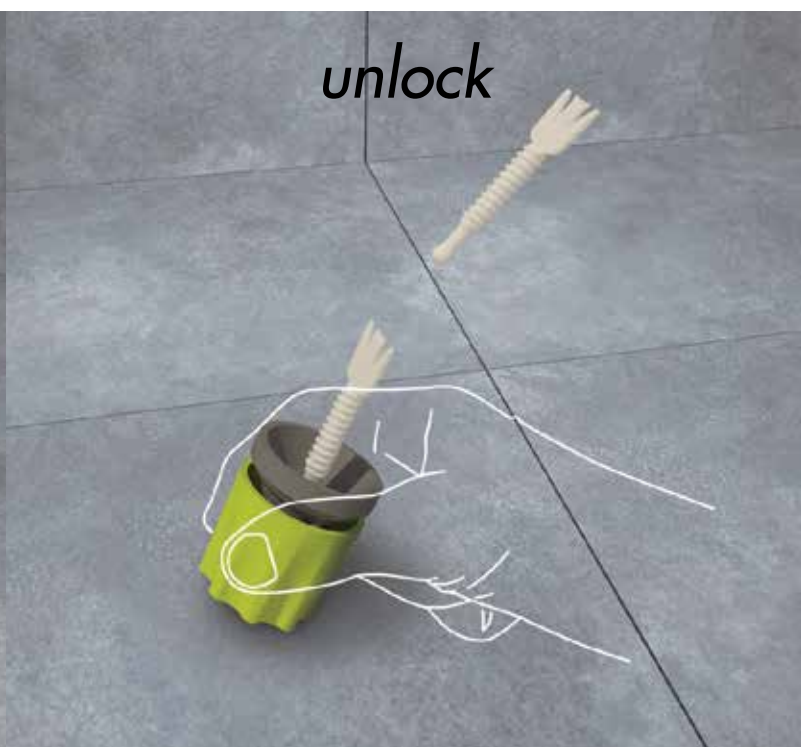

The tiles, in particular those of big format, during the laying may not be perfectly calibrated. In the drying step of the adhesive there may be shrinkages and sinkings that are not evident during the installation.

The use of the **Leveltec** allows the perfect alignment of the upper surface of the floor with the surface of the wall, compensating not the non-planarity and the following glue shrinkage.

Code	Description	pcs.	pcs. □	pcs. □
LEV/M	Automatic cap assembled	50	300	2400
LEV/17	Tie-base thickness 1,7 mm	250	2500	30000
LEV/10	Tie-base thickness 1 mm	250	2500	30000

**N.B.** The tie-base allows tiling according to the UNI 11493 standards ( 2 mm)



# fix head support SUPF

Paving support by Profilitec Spa for floating floors with 25 to 270 mm height fix head. The support is adjustable.

Bi-material head pp+rubber anti-noise and anti-slip.

4 pre-cut tabs to get a joint width of 2,3 mm easily removable. ( on request available also with 4 mm tabs).

**Noise reduction up to 25 DB ( from 77 DB to 52 DB).**

**Exclusive coupling head on screw**

**Block-System for safe assembly of various components**

**Base diameter : 205 mm**

**Base thickness: 2 mm**

**Head diameter: 110 mm**

**Bottom base 0,033 mq**

**Minimum height 28 mm**

**Maximum Height 270 mm**

**Weight: da 0,22 kg – 0.58 kg**

**Installation:**

The product does not require glue for the installation.

On the corners and along the perimeter part of the base has to be removed for a correct installation (along the pre-cut lines).



**Note:** The floor height adjusting has to be made with maximum 2 tiles for each support



SUPF60/100



APPLICATION EXAMPLE WITH BSR\*

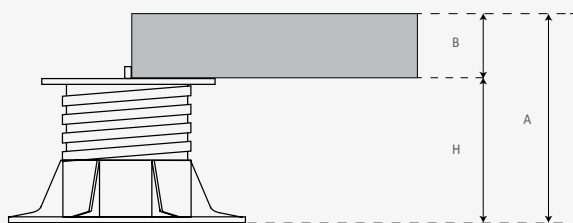

**CALCULATING OF THE SUPPORT'S HEIGHT:**

A= Height of the finished floor

B= Height of the flooring plate

H= Height of the support

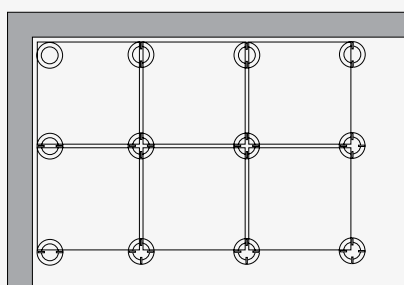

**APPLICATION EXAMPLE:**

Paving slab size	Quantity/m <sup>2</sup>
cm 60x60	2,78 supports/pcs
cm 50x50	4 supports/pcs
cm 40x40	6,25 supports/pcs
cm 30x30	11,11 supports/pcs

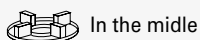

In the middle



Along the wall



At the corner



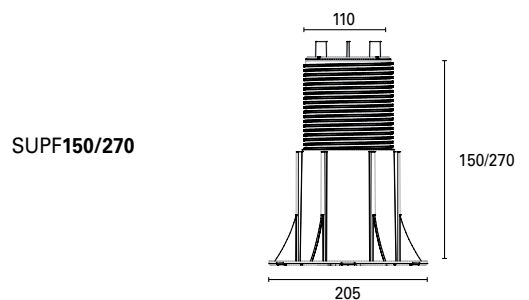
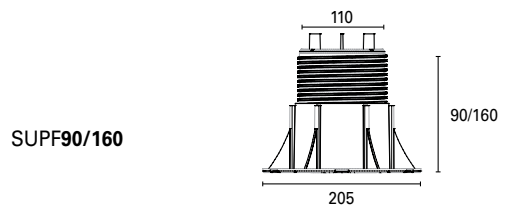
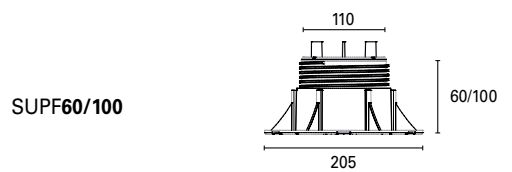
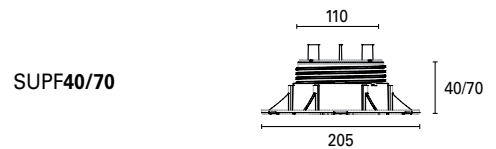
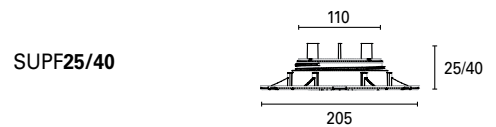
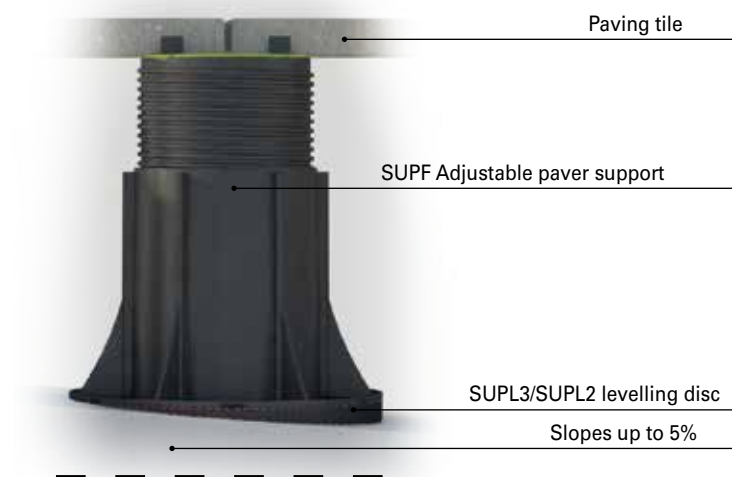

	Article	SUPF25/40	SUPF40/70	SUPF60/100	SUPF90/160	SUPF150/270
Support material: Polypropylene	Height	25-40 mm	40-70 mm	60-100 mm	90-160 mm	150-270 mm
Hardness: Shore D(70)	Resistance to central compression	31,15 KN	38,65 KN	46,50 KN	29,55 KN	28,60 KN
Fire resistance: UNI:EN 13501-1:2009 Fire Rating E	Resistance to eccentric compression	15,15 KN	21,45 KN	26,05 KN	16,75 KN	18,85 KN
Resistance to low temperatures: -40°C						
Production: Made in Italy						

	Accessories					
	Levelling disc		2 mm	SUPL2		
	Levelling disc		3 mm	SUPL2		
	Adjustment key			SUPK		

SUPL2 - SUPL3 (noise reduction of 3 DB from 52 DB to 49 DB).



# self leveling head support *SUPA*

Paving support by Profilitec Spa for floating floors with 28 to 120 mm height adjustable self-levelling head. The support is adjustable.  
Bi-material head pp+rubber anti-noise and anti-slip.  
4 pre-cut tabs to get a joint width of 2,3 mm easily removable. ( on request available also with 4 mm tabs).

**Noise reduction up to 25 DB (from 77 DB to 52 DB).**  
**Exclusive coupling head on screw**  
**Block-System for safe assembly of various components**  
**The adjusting head is self-levelling and allows automatic slope compensation up to 5%.**  
**Base diameter : 205 mm**  
**Base thickness: 5 mm**  
**Head diameter: 110 mm**  
**Bottom base 0,033 mq**  
**Minimum height 28 mm**  
**Maximum Height 120 mm**  
**Peso: 0,26 kg – 0,455 kg**

**Installation:**  
The product does not require glue for the installation.  
On the corners and along the perimeter part of the base has to be removed for a correct installation (along the pre-cut lines).



**N.B.:** Height support adjustment with maximum 2 tiles in place per support

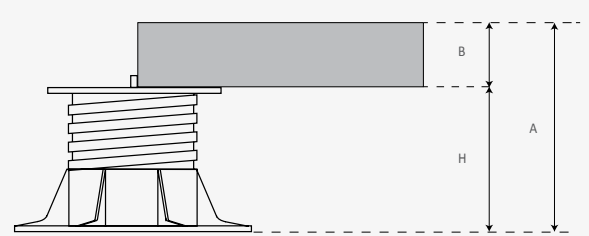

**CALCULATING OF THE SUPPORT'S HEIGHT:**

A= Height of the finished floor  
B= Height of the flooring plate  
H= Height of the support

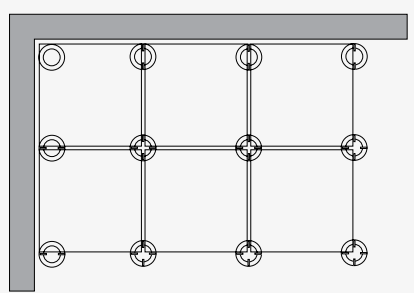

**APPLICATION EXAMPLE:**

Paving slab size	Quantity/m <sup>2</sup>
60x60 cm	2,78 supports/pcs
50x50 cm	4 supports/pcs
40x40 cm	6,25 supports/pcs
30x30 cm	11,11 supports/pcs



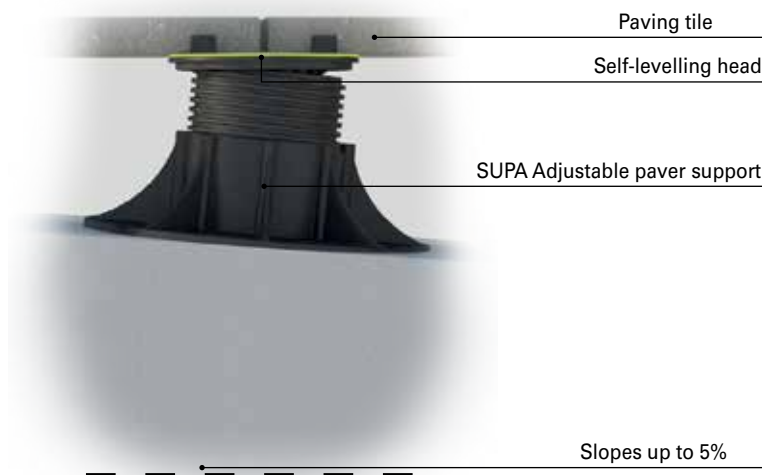

SUPA28/38

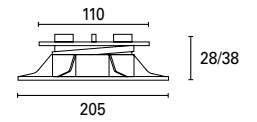

SUPA37/50

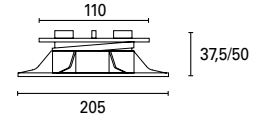

SUPA50/75

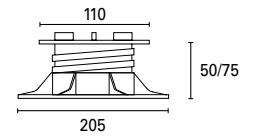

SUPA75/270

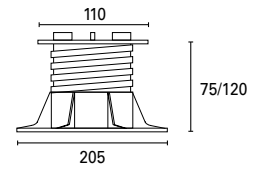

	Article	SUPA28/38	SUPF37/50	SUPA50/75	SUPA75/120
Supports material: Polypropylene	Height	28-38 mm	37,5-50 mm	50-75 mm	75-120 mm
Hardness: Shore D(70)	Resistance to central compression	19,90 KN	16,05 KN	16,45 KN	19,55 KN
Fire resistance: UNI:EN 13501-1:2009 Fire Rating E	Resistance to eccentric compression	11,60 KN	11,45 KN	14,00 KN	15,20 KN
Resistance to low temperatures: -40°C					
Production: Made in Italy					



Perforated plastic spacers for a regular and gauged grout joint tiling in wall and floor coverings. Realised in synthetic material resistant to chemical agents. Available in all the sizes normally required by tile joints. Their anti-floating shape is conceived to keep the spacer imbedded into the fresh grout during tiling and beating. Delivered in 500 pcs bags organized in dispenser displays.

# DIC-DIT

**Note:** The spacers colours could be changed compared to those reported in the pictures



### DIC/DIT spacers requirement scheme

Tile size (cm.):	60x60	60x30	40x40	40x30	40x20	33x33	30x30	30x20
Quantity for mq.:								
Cross shaped spacer +:	6	12	14	18	24	18	22	34
T shaped spacer:	3	6	7	9	12	9	11	17

Tile size (cm.):	25x25	20x20	15x15	13x26	13x13	10x20	10x10
Quantity for mq.:							
Cross shaped spacer +:	32	50	88	60	120	100	200
T shaped spacer:	16	25	44	30	60	50	100

### CROSS shaped spacer DIC

Manufactured in polypropylene. 4 mm thickness for the spacers 1-2-3-4-5 mm wide, 6 mm for the DIC 70 and 8 mm for the DIC 100.

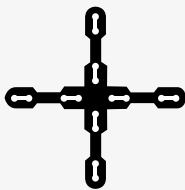

	L=mm	Art.
Material:	1	DIC 10
Polypropylene	2	DIC 20
Lengths:	3	DIC 30
1, 2, 3, 4, 5, 7, 10 mm	4	DIC 40
	5	DIC 50
	7	DIC 70
	10	DIC 100

### "T" shaped spacers DIT

Manufactured in polypropylene. 4 mm thickness for the spacers 1-2-3-4-5 mm wide, 6 mm for the DIT 70 and 8 mm for the DIT 100.



Material:	1	DIT 10
Polypropylene	2	DIT 20
Lengths:	3	DIT 30
1, 2, 3, 4, 5, 7, 10 mm	4	DIT 40
	5	DIT 50
	7	DIT 70
	10	DIT 100

### Wedge DIS

Manufactured in polypropylene. 5 mm height. Helps to compensate possible screed level differences.

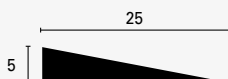

Material:	5	DIS 50
Polypropylene		





New 'Dispenser' boxes make it easier to take out cross and "T"-shaped spacers for tile laying.

The contents size is stamped on every plastic bag you pull out from the new front dispenser. This enables to have always an ordered warehouse of all sizes, helping the stock recovery, with the right size and the item code always at hand.

The boxes are superimposable and multiple of a pallet to optimise the transport and the stocking.

# dispenser *DIC-DIT*



Frontal content size label for an immediate stock check.

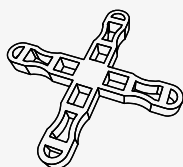

Content	Art.	Size	Pcs for Set	N. Set
<input type="checkbox"/>	DIC 10	1 mm	500	60
<input type="checkbox"/>	DIC 20	2 mm	500	60
<input type="checkbox"/>	DIC 30	3 mm	500	50
<input checked="" type="checkbox"/>	DIC 40	4 mm	500	40
<input type="checkbox"/>	DIC 50	5 mm	500	40
<input type="checkbox"/>	DIC 70	7 mm	500	15
<input type="checkbox"/>	DIC 100	10 mm	500	10

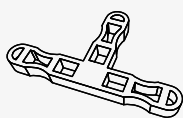

<input type="checkbox"/>	DIT 10	1 mm	500	60
<input type="checkbox"/>	DIT 20	2 mm	500	60
<input type="checkbox"/>	DIT 30	3 mm	500	50
<input type="checkbox"/>	DIT 40	4 mm	500	40
<input type="checkbox"/>	DIT 50	5 mm	500	40
<input type="checkbox"/>	DIT 70	7 mm	500	15
<input type="checkbox"/>	DIT 100	10 mm	500	10

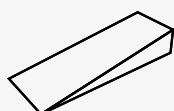

<input type="checkbox"/>	DIT 50	5 mm	500	50
<input type="checkbox"/>				



Polypropylene supports for laying of floating tiles and floor coverings. Good resistance to ice and atmospheric agents. It is an easy to use system that can adjust the covering to different heights thanks to the available shims. Ideal for large balconies, terraces, verandas walkways and roof gardens. Placed directly onto the sloping bituminous waterproofing layer they provide an effective drainage system and ensure maintenance of the waterproofing layer over time.

# SET

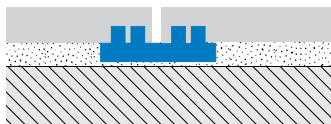

### Plastic support discs for floating stone tiles

Manufactured in Polypropylene. Drilled in the lower part to enable water drainage. They prevent cracking of the tiled floor due to ice or water seepage. Simple to remove, they allow easy repair and upgrading of the damaged bituminous layer. Any required height or possible sub-floor unevenness can be matched with the available shims.

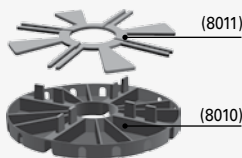

	H=mm	Art.
Material:	13	8010 set
Polypropylene	3	8011 set spessore

### SUPPORT for cement laid floating tiles

Aids installation by allowing the cement to be accurately placed beneath the tiles while fixing the tiles at the edges and ensuring an adequate amount of drainage beneath the tiles. Cross-shaped 3 mm thick spacers available, to apply in the central part.

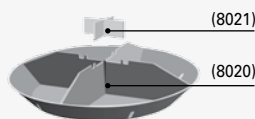

	H=mm	Art.
Material:	20	8020 set
Polypropylene	3x15	8021 set spessore

N.B.: 8021 Thickness 3 mm, Height 15 mm



A magnetic device for creation of a discrete tiled acces panel with four magnetic tabs placed on the corners. It is a universal application suitable for all types of tiles, ensuring a neat finish. Can be easily removed and replaced at all times.

mag+tec™

**INSTALLATION:**

Determine on the wall the inspecting panel position and size. The panel sides should correspond to square modules of one or more tiles connected with a support base. Glue the 4 fixing plates on the wall covering tile rear side, along the inspecting panel opening. Make an access panel by fixing the four magnets with adhesive, one on each corner, on the single tile or tile-panel created previously, checking that they are well aligned with the plates on the wall.

Make sure that the adhesive is completely dry before placing the inspection panel back on the wall.

If necessary seal along the inspecting panel perimeter with silicon. This seal may subsequently be cut to allow removal of the panel.

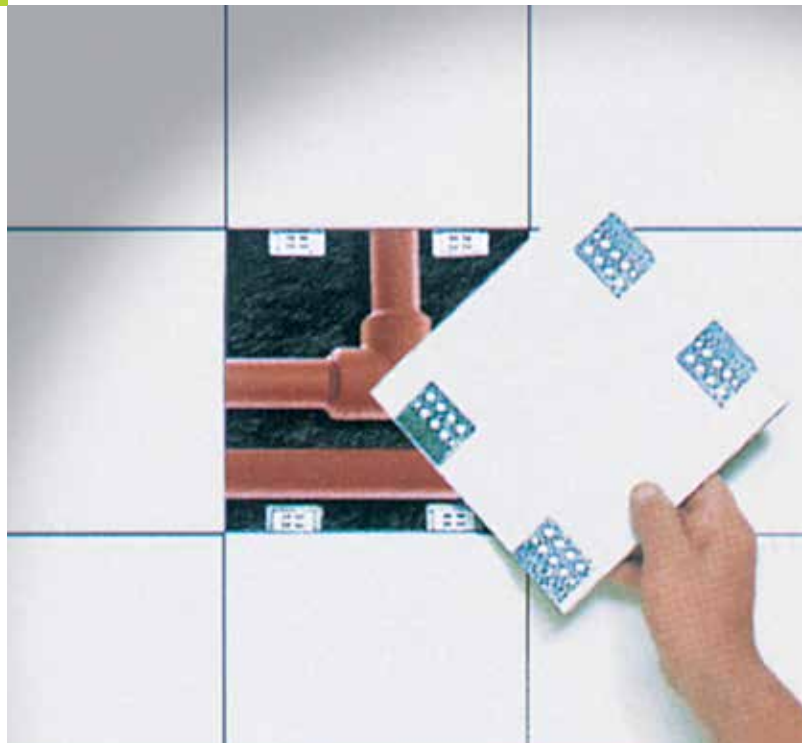

**Magnetic tabs for tile panel - wall inspection**

Metal tabs with magnetic elements fixed to them. 4 tabs with magnets plus 4 perforated backing fixing plates.

	Description	Art.
Material: Galvanised steel	4 magnets + 4 plates	MAG





entrytec™ BU

Matwell frame to create, finish and protect a recess in the sub-floor that is used to accommodate an entrance barrier mat.

ENTRYTEC BU can accommodate entrance mats up to 23 mm in thickness and is reversible to allow quick installation of the most popular mat thicknesses (18 mm and 23 mm).

The matwell can also be infilled with screed to suit thinner gauge entrance mats. The matwell frame is supplied with fixing connectors for easy on-site assembly and is fixed to the substrate prior to screeding and mat installation.

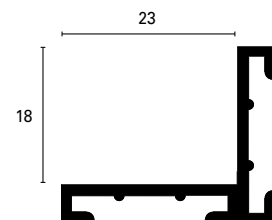

Illustrated scale dimension 1:1

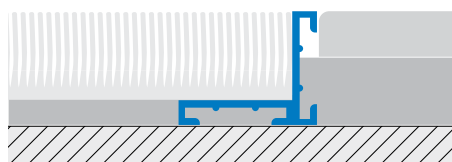

**ENTRYTEC BU 18/23 AS Anodised Aluminium Silver**

Reversible profile in aluminium. It can match two different entrance mat thicknesses.

	H+H¹		Art.	
Material: Extruded Anodised aluminium	18/23	BU	18/23	AS
Finish: Silver (AS)				
Length: 2,70 metres				

**ENTRYTEC BU 18/23 ON Natural brass**

Reversible brass profile. It can match two different entrance mat thicknesses.

Material: Extruded Natural Brass	18/23	BU	18/23	ON
Finish: Natural (ON)				
Length: 2,70 metres				

**ENTRYTEC BU\* Mounting Accessories**

Natural brass fixing clamp to put down in the cement and internal corners bracket in natural aluminium to help junction of 45° cut profiles.

		BUS	20	ON
		BUI	20	AN





Profiles and accessories for stair carpeting.  
Hollow section triangular or round stair rods manufactured both in brass and aluminium to be installed either with fixed or opening supports, for an easy carpet cleaning.

# stair carpet profiles



## Brass fixing support for triangular stair rod

Opening polished brass supports for triangular rods to be fixed with screws. To match with rectangular rods Code TTR 16 AO and TTR 16 OL



		Art.		
Material: Brass		STR	13	OL
Finish: Polished (OL)				

## Triangular stair rod

To fix with the Polished Brass supports Code STR 13 OL.

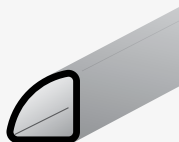

		BxH	Art.		
Material: Extruded aluminium Extruded Brass	16x16 16x16	TTR TTR	16 16	AO OL	
Finish: Bright polished gold (AO), Polished (OL)					

## Brass fixing support for round stair rods

Polished brass fixing supports for round stair rods complete with fixing self-tapping screw to match with round stair rods in gold anodised aluminium Code TTO-AO and in polished brass Code TTO-OL.  
Chromed version available for rod diameter 11 mm, Code SUP 12 OC.



		ø	Art.		
Material: Polished Brass	12 14 16	SUP SUP SUP	12 14 16	OL OL OL	
Finish: Polished (OL)					

## Polished Brass hinge fixing support

Polished brass hinge fixing supports for round stair rods to be fixed with screws, matching with round stair rods in gold anodised aluminium Code TTO-AO and in polished brass Code TTO-OL.

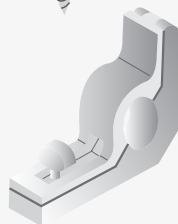

Material: Polished Brass	12 14 16	CER CER CER	12 14 16	OL OL OL
Finish: Polished (OL)				

## Pre-cut stair rods

In brass or anodised aluminium gold finish. Available in 80,90,100 and 120 cm length, complete with end caps.  
Stair rods are also available in 3,20 m lengths with end caps to be ordered separately Art. TAP-OL. To be fixed with the eyelet supports Art. SUP-OL or with hinge support Art. CER-OL.  
Bright polished-chrome aluminium version available for rod diameter 11 mm in 3,2 m length, Code TTO 11 ASB, with relevant end caps in chromed brass, Code TAP 11 OC and supports SUP 12 OC.

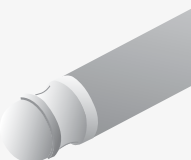

		ø11		ø13		ø15	
Material: Anodised Aluminium, Brass	TTO TTO	11 11	AO OL	TTO TTO	13 13	AO OL	TTO 15 15 OL
Finish: Gold (AO), Polished (OL)							



Customized profiles designed and manufactured in our production facilities to satisfy all technical demands, whether it is to simply cover over a joint gap or partition or to provide special joint, protection or refurbish trim or edging, whenever our standard profiles are not able to meet the project requirements. Flexibility and expertise to meet all specifications, with a punctual and reliable service even for a limited quantity order.

# profilies *DIY*

### Required specifications:

- a) Dim. of each side (mm): Required specifications
- b) Required finish:
  - Natural
  - Polished
  - Brushed
- c) Option:
  - Perforated
  - Pre-drilled
  - Self-adhesive
- d) Holes:
  - Countersunk
  - Not countersunk
- e) Holes: Position and visible side
- f) Standard Length: 2,00 metres
- g) Available material:
  - Aluminium: 1,5 mm
  - Stainless Steel : 1 mm - 1,2 mm
  - Brass: 1 mm - 1,2 mm

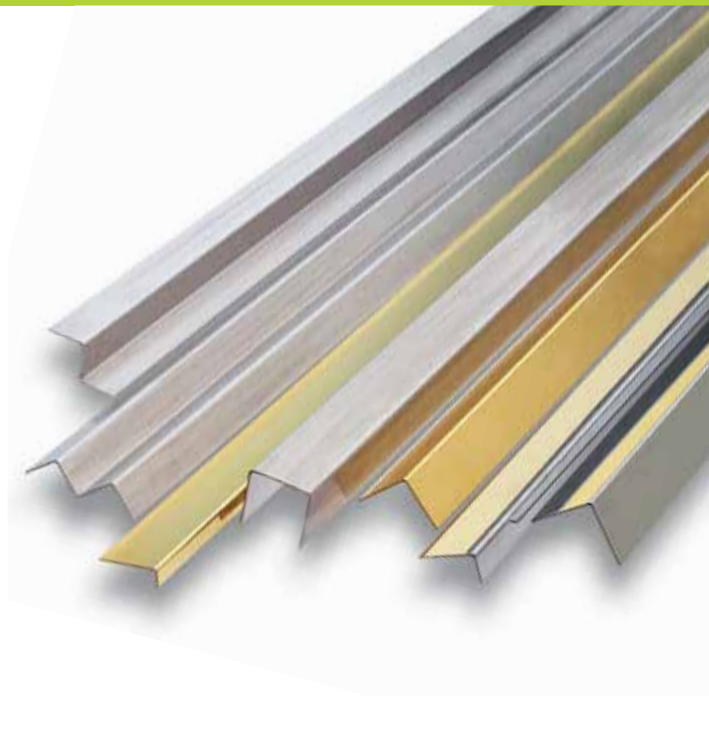



### ALUMINIUM:

	AxBxC	Art.	Finishes	
 <b>Equal angled section</b> Material: Aluminium Finish: Silver (AS), Gold (AO), Bronze (AB) Length: 2 metres on request: 1 m	10x10x1	PA	10X10	AS/AO/AB
	15x15x1	PA	15x15	AS/AO/AB
	20x20x1	PA	20x20	AS/AO/AB
	25x25x1	PA	25x25	AS/AO/AB
	30x30x1,5	PA	30x30	AS/AO/AB
	40x40x1,5	PA	40x40	AS/AO/AB

	AxBxC	Art.	Finishes	
 <b>Flat Profile</b> Material: Aluminium Finish: Silver (AS), Gold (AO), Bronze (AB) Length: 2 metres on request: 1 m	12x2	PP	12x2	AS/AO/AB
	15x2	PP	15x2	AS/AO/AB
	20x2	PP	20x2	AS/AO/AB
	25x2	PP	25x2	AS/AO/AB
	30x2	PP	30x2	AS/AO/AB

 <b>"L" profile</b>	AxBxC	Art.	Finishes	
	15x10x1	PL	15x10	AS/AO/AB
	20x10x1	PL	20x10	AS/AO/AB
	30x15x1	PL	30x15	AS/AO/AB

 <b>"U" profile</b>	AxBxC	Art.	Finishes	
	8x8x1	PU	8x8	AS/AO/AB
	10x10x1	PU	10x10	AS/AO/AB
	10x15x1	PU	10x15	AS/AO/AB

 <b>Bullnosed profile</b>	AxBxC	Art.	Finishes	
	18	UN	18 A*	AS/AO/AB
	22	UN	22 A*	AS/AO/AB
	25	UN	25 A*	AS/AO/AB

 <b>Round</b>	AxBxC	Art.	Finishes	
	ø15x1	TT	15	AS/AO/AB
	ø18x1	TT	18	AS/AO/AB
	ø20x1	TT	20	AS/AO/AB

**ALUMINIUM:**

	AxBxC	Art.	Finishes	
<b>Square</b>				
Material: Aluminium	10x10x1 15x15x1	TQ	10x10 15x15	AS/AO/AB AS/AO/AB
Finish: Silver (AS), Gold (AO), Bronze (AB)	20x20x1	TQ	20x20	AS/AO/AB
Length: 2 metres on request: 1 m				



	AxBxC	Art.	Finishes	
<b>Rectangular</b>				
	20x10x1 30x15x1	RE RE	20x10 30x15	AS/AO/AB AS/AO/AB



	AxBxC	Art.	Finishes	
<b>"T" profile</b>				
	15x15x1,5 25x25x1,5	PT PT	15x15 A* 25x25 A*	AS/AO/AB AS/AO/AB



	AxBxC	Art.	Finish	
<b>"W" Profile</b>				
Material: Aluminium	16x12x1 20x10x1	CD CD	16x12 20x10	AS/AO/AB AS/AO/AB
Finish: Silver (AS), Gold (AO), Bronze (AB)				
Length: 2 metres on request: 1 m				



	AxBxC	Art.	Finish	
<b>Square</b>				
	8x8	QU	8	AS/AO/AB



	AxBxC	Art.	Finish	
<b>Ronde</b>				
	8x8	TO	8	AS/AO/AB

**BRASS:**

	AxBxC	Art.	Finishes	
<b>Equal angled section</b>				
Material: Brass	15x15x1 20x20x1	PA PA	15x15 20x20	OL OL
Finish: Polished (OL), Natural (ON)	25x25x1 30x30x1	PA PA	25x25 30x30	OL OL
Length: 2 metres on request: 1 m	35x35x1 40x40x1 50x50x1	PA PA PA	35x35 40x40 50x50	OL OL OL



	AxBxC	Art.	Finishes	
<b>"L" profile</b>				
	15x10x1 20x20x1 30x15x1	PA PA PA	15x10 20x20 30x15	OL OL OL



	AxBxC	Art.	Finishes	
<b>Equal angled section</b>				
	15x15x1,5 20x10x1,5 25x25x1,5	PAP PAP PAP	15x15 20x10 25x25	ON ON ON



	AxBxC	Art.	Finishes	
<b>"L" profile</b>				
	25x15x1,5	PAP	25x15	ON

**PVC:**

	AxBxC	Art.	Colours	
<b>Equal angled section</b>				
Material: PVC	10x10x1,4 15x15x1,4	PA PA	10x10 15x15	P11/P63 P11/P63
Colours: Pure white (P11), Dark brown (P63)	20x20x1,4 25x25x1,4 30x30x1,4	PA PA PA	20x20 25x25 30x30	P11/P63 P11/P63 P11/P63
Length: 2 metres on request: 1 m				



	AxBxC	Art.	Colours	
<b>"L" profile</b>				
	15x10x1,4 20x10x1,4 30x15x1,4	PL PL PL	15x10 20x10 30x15	P* P* P*

**STAINLESS STEEL:**

	AxBxC	Art.	Finish	
<b>Equal angled section</b>				
Material: Stainless steel	15x15x1 20x20x1	PA PA	15x15 20x20	IL IL
Finish: Polished (IL)	25x25x1 30x30x1	PA PA	25x25 30x30	IL IL
Length: 2 metres on request: 1 m	35x35x1 40x40x1 50x50x1	PA PA PA	35x35 40x40 50x50	IL IL IL



	AxBxC	Art.	Finish	
<b>"L" profile</b>				
	15x10x1 20x10x1 30x15x1	PL PL PL	15x10 20x10 30x15	IL IL IL



## installation guide - lines

### + INSTRUCTIONS FOR LAYING PROFILES WITH THE SAME ADHESIVE USED FOR COVERING MATERIAL:

- 1) Choose the profile with a height which corresponds to the thickness of the covering material and pay special attention to not let the profile top face rise above the paving surface - it is actually best to fix it approx. 0,5÷1 mm below the tiled surface.
- 2) Trowel the adhesive over the entire area of the profile application.
- 3) Cut the profile to desired length and embed it with the perforated flange down into the screed bedding while keeping it perfectly aligned.
- 4) Trowel an additional layer of adhesive on the perforated flange and in the small gaps along the profile vertical section flush with the covering edge.
- 5) Leave an approx. 2 mm space between the profile and the tile edge to be filled over with the common grout or sealant normally used for tiling.

**Note:** Aluminium profiles bear a limited tolerance to alkaline. Therefore it is advisable to evaluate their use considering their expected exposure to chemical agents.

Through contact with cementitious compounds, aluminium profiles may be subject to corrosion processes, therefore it is best to make sure to remove immediately any excess glue/grout. In addition it is important to use the proper quantity of glue and respect the adequate drying time in order to prevent formation of water stagnation gaps with consequent production of alkaline substances that may trigger a potential electrolyte phenomenon.

### + INSTRUCTIONS FOR SELF-ADHESIVE PROFILES INSTALLATION:

- 1) Check that the surface is solid, even and clean, free from dirt and greasy substances and that the temperature is not below 15 °C.
- 2) Cut the profile to the desired length, remove protective film for the adhesive part and position the profile without any further adjustments.
- 3) Apply and press evenly without hammering.

### + INSTRUCTIONS FOR LAYING DRILLED PROFILES WITH SCREWS AND DOWELS:

- 1) Cut the profile to the desired length.
- 2) Align the profile marking the holes position according to the profile pre-drilled holes.
- 3) Insert dowels and screws in using countersunk-head screws suitable for the profiles holes (for threshold profiles application: use 3 mm size screws and 5x25 mm dowels).

### + INSTRUCTIONS FOR THIN BED EXPANSION JOINTS INSTALLATION WITH THE SAME ADHESIVE USED FOR COVERING MATERIAL:

- 1) Select the profile in consideration of the load and expansion rates it will be subject to, with a height which corresponds to the thickness of the covering material and pay special attention to not let the profile top face rise above the paving surface - it is actually best to fix it approx. 0,5÷1 mm below the tiled surface.
- 2) Trowel the adhesive over the entire area of the profile application.
- 3) Cut the profile to desired length and embed it with the perforated flange down into the screed bedding while keeping it perfectly aligned.
- 4) Trowel an additional layer of adhesive on the perforated flange and in the small gaps along the profile vertical section flush with the covering edge.
- 5) Leave an approx. 2 mm space between the profile and the tile edge to be filled over with the common grout or sealant normally used for tiling.

**Note:** Aluminium profiles bear a limited tolerance to alkaline. Therefore it is advisable to evaluate their use considering their expected exposure to chemical agents.

Through contact with cementitious compounds, aluminium profiles may be subject to corrosion processes, therefore it is best to make sure to remove immediately any excess glue/grout or sealant. In addition it is important to use the proper quantity of glue and respect the adequate drying time in order to prevent formation of water stagnation gaps with consequent production of alkaline substances that may trigger a potential electrolyte phenomenon.

### + INSTRUCTIONS FOR MOVEMENT JOINTS SCREED- DEEP BED INSTALLATION:

- 1) Select the profile with a height matching the screed entire depth.
- 2) Embed the profile in the existing screed gap or position it and then proceed with the paving making sure that the profile protrudes of 2 to 3 mm above the final finished surface of floor.
- 3) Tile as normal and flush the profile with the tile surface with a rubber hammer protecting it with a wooden batten.
- 4) Proceed with the grouting as normal making sure that all inter-spaces between tile and profile are filled in.



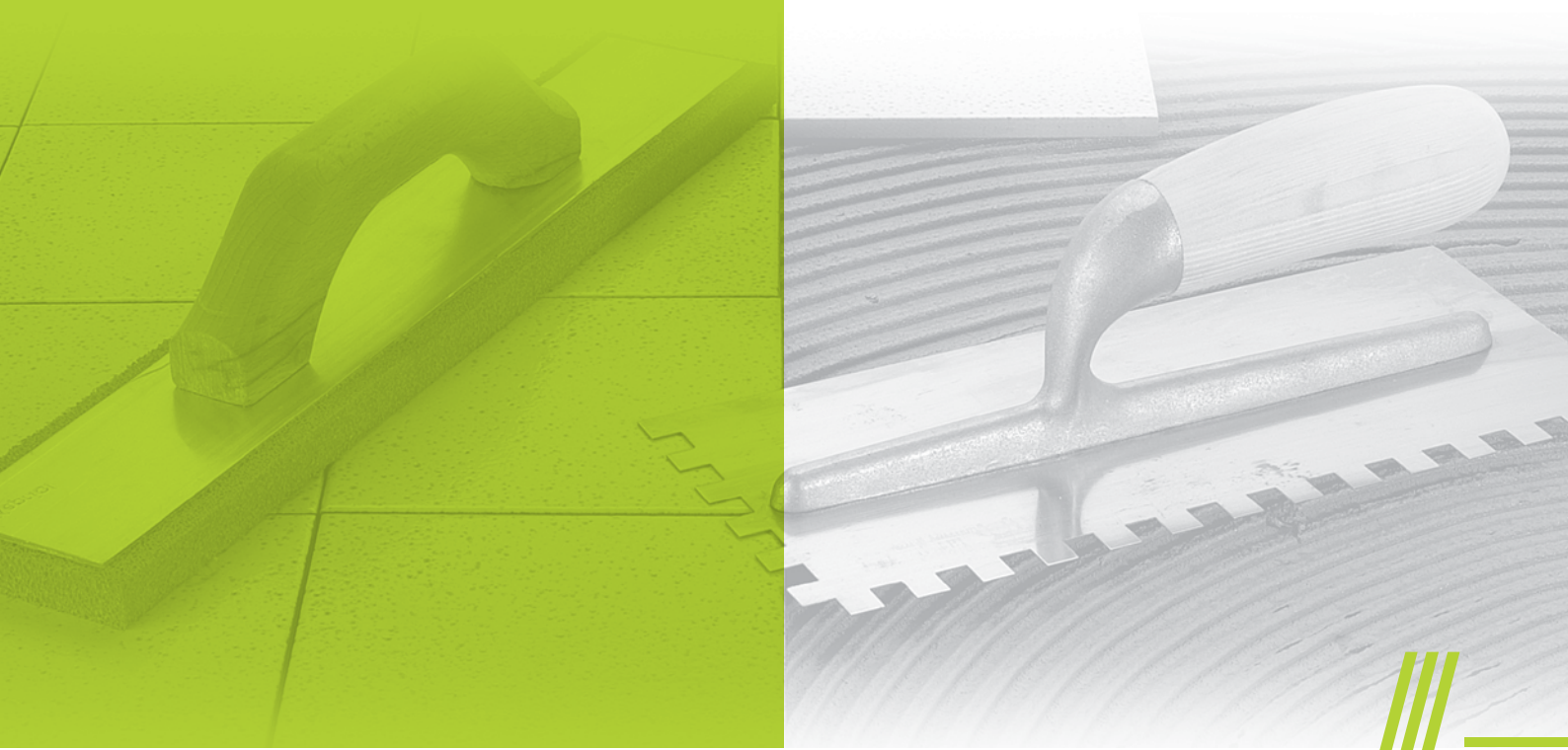

### + INSTRUCTIONS FOR STRUCTURAL EXPANSION JOINTS INSTALLATION:

- 1) Initially check all edge borders of the profile to verify its suitability to work purpose.
- 2) If necessary, level out the underlying bedding where the profile is to be positioned with a 10 cm wide soft mortar layer considering that the joint must eventually flush with the finished floor. It is imperative that the profile does not protrude above the flooring surface.
- 3) Slip the rubber infill into the metal insert before aligning the expansion joint in site.  
It is advisable to protect the rubber with some adhesive tape to avoid any cement spot.
- 4) Align the profile checking its linearity and fix the flange wings into the mortar bedding with chemical or mechanical expansion plugs sized according to the load stress expected on the structure and to the sub-floor characteristics.
- 5) The fastening must be in parallel correspondence of each side running the plugs insert on alternately every 30 cm. down the flange holes.
- 6) If necessary and depending on the covering material, it is advisable to make a 3 to 5 mm elastic sealing between profile and tile edge.

The load capacity is effective only providing that the joint profile installation has been properly executed, in strict observance of the given technical instructions as far as the estimated expansion rates, possible extra dynamic loads and the sub-floor consistency are concerned.

### + GENERAL INDICATIONS:

For less than 12 mm wide thin bed application expansion joints to be installed while tiling and deep bed application expansion joints, the maximum permitted loading is not indicated with a specific icon. In reality joints of such a limited width are not affected by tyre load which is mostly diffused on the covering surface. Metal joints generally have a good resistance against vehicle passage and rubber wheeled fork-lift trucks transit, thus increasing the covering edge protection.

Calculations relating to expansion joints, correct positioning, sizing and selection of the same should be carried out by the planner taking the following points into consideration: estimated structural and flooring movements, traffic type, presence of possible external agents. More specific technical information are available on request.

See also general warranties on page 268.

### STRUCTURAL JOINTS ICONS KEY



Horizontal expansion due to structural settlements, beam bays shrinkage-flexion and shrinkage-compression movements depending on load variation; expansion due to changes in temperature.



Vertical movements due to structural settlement and to different sinking-settlement rates in the connection between two semi-detached buildings.



Rubber wheeled supermarket trolleys, stretchers and airport or hotel luggage trolleys.



Car advancing slowly with a wheel load of 600 kg without increase in load due to swerve.



Fork-lift trucks and transport vehicles (DIN 1055) with solid rubber tyres (maximum permitted tyre load as indicated in specific icon, calculated based on a wheel imprint of 20 x 20 cm). Note that loading is strictly linked to wheel dimensions and to possible dynamic increases not taken into consideration in the indicated values.



Rubber tyred vehicles (DIN 1072) advancing slowly (maximum permitted tyre load as indicated in specific icon, calculated based on a wheel imprint of 20 x 40 cm).

Note that loading is strictly linked to wheel dimensions and to possible dynamic increases not taken into consideration in the indicated values.



Vulkollan or polyamide wheeled fork-lift trucks and transport vehicles with wheel load as per diagram below. Wheels entirely in metal are excluded.

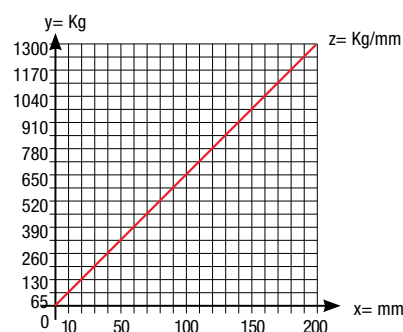

Diagram of maximum permitted load for synthetic material wheeled trolleys. Load behaviour relating to wheel dimensions is illustrated in the example.

X= Wheel width (mm)  
Y= Wheel max. load (Kg)  
Z= 6,5 Kg/mm wheel width



## raw materials



### ALUMINIUM:

Composed of a primary alloy particularly suitable for more complex extrusion processes, it offers a high general tolerance along with a quality top at a natural state for further finish treatments. Hot tempered this metal alloy bears a 70 Kg/mm<sup>2</sup> Brinell HP hardness.

### LEGA Al Mg 0,5 Si 0,4 Fe 0,2 UNI 9006/1 EN 573/3 EN AW 6060

Mg%	Si%	*Fe%	*Ti%	*Cu%	*Cr%	*Mn%	*Zn%	Altro%	Al%
0,35÷0,60	0,30÷0,60	0,30	0,10	0,10	0,05	0,10	0,15	0,05÷0,15	Resto

\* Maximum permitted values

### ANODISED ALUMINIUM:

Anodic oxidation process against corrosion generated by atmospheric agents not associated with galvanization processes. Profiles are previously treated so as to become uniformly mat and subsequently electro-chemically oxidized and coloured in the standard Silver, Gold, Bronze, Copper and Titanium, with a coating till 20 micron.

### BRIGHT POLISHED ALUMINIUM:

It consists of a special pre-shine chemical/machine process and then of a colour dip for Gold, Chrome, Copper and Titanium finish. The profile product maintains the same chemical and mechanical resistance qualities as the anodised versions with an aesthetic bright appearance which make it similar to gilt or chromed surfaces.

### POWDER COATED ALUMINIUM:

The powder coating procedure starts with a chrome-phosphate pre-treatment to proceed then with a polyester powder base coating through electrostatic method. This results in an elevated tolerance to atmospheric agents and UV stabilization. The entire profile undergoes an average 60 micron coating. In addition, the colour fastness by heat impression supplies a further guaranteed resistance to mechanical impact and chemical aggression.



### STAINLESS STEEL:

Stainless steel profiles are produced through cold rolling procedure with a steady thickness control. They differ then from the correspondent aluminium or brass profile version manufactured with hot extrusion processes, of which they maintain nevertheless the application and dimensional characteristics. Stainless steel effectively resist to

high mechanical solicitations and is particularly indicated for chemical, food-processing and hospital environments, to meet with the hygiene, durability and chemical resistance requirements.

The brushing and mid-polishing finish process is obtained through quartz-fibre nylon rotary brushes which create the mat effect on the profile but leave the characteristics unaltered.

Manufactured in different grades/standards, whose main characteristics are indicated below:

AISI	DIN	*C	Cr	Ni	*Si	*Mn	Mo
430	1,4016	0,10	16,0÷18,0	-	1,0	1,0	-
304	1,4301	0,07	17,0÷19,5	8,0÷10,5	1,0	2,0	-
316L	1,4404	0,03	16,5÷18,5	10,0÷13,0	1,0	2,0	2,0÷2,5

\* Maximum permitted values

#### STAINLESS STEEL AISI 430 – EN X 8 CR 17 – DIN 1,4016:

Steel belonging to the FERROUS Ferrite category; considered as stainless even if in areas subject to particularly corrosive agents, it may stain and be subject to partial oxidation depending on the materials it is associated with during installation.

#### STAINLESS STEEL AISI 304 – EN X 5 CRNI 18 10 – DIN 1,4301:

Steel belonging to the AUSTENITE category which composes the most popular alloy aggregate for a performing product. It is resistant to most commonly used chemicals but it may spot or darken on top surface. In such case, it is easily buffed out with a conventional polishing product to bring it back to its original shine.

#### STAINLESS STEEL AISI 316 – EN X 2 CRNIMO 17 12 2 – DIN 1,4404:

Steel belonging to the AUSTINITE category; its alloy aggregate comprises Nickel, Chrome and Molybdenum, the latter conferring an excellent resistance to harsher conditions.



### BRASS:

Brass profiles are characterized by a high tolerance to mechanical stress which promotes them as highly indicated products for flooring and coverings with intense transit, like industrial applications and in correspondence to expansion joints.

Brass also offers a high resistance to chemical agents normally present during ceramic tile laying. In case of constant presence of humidity the brass may suffer from oxidation and consequently darken. Spotting can be easily removed with a conventional polishing product to bring it back to its original shine.

Brass profiles are manufactured either from hot extrusion or cold rolling processes with a steady sheet thickness control.

#### COLD ROLLING ALLOY Cu Zn 40 Pb2 Al EN 12167 CW 618N

**Cu%	*Pb%	*Sn%	*Fe%	*Ni	**Al%	Zn%
58	2,6	0,20	0,20	0,10	0,15	Resto

#### COLD ROLLING ALLOY Cu Zn 37 EN 1652 CW 508L

**Cu%	*Pb%	*Fe%	Zn%	Impurità%
67	0,1	0,1	Resto	0,30

\*\*Reference values \* Maximum permitted values

#### POLISHED BRASS:

Our polishing finish is performed by special buffing machines which enhance the natural shine of the material without altering its mechanical properties. Over time there may be a slight oxidation but the darkened area may be brought back to their original shine by use of a standard polishing product.

#### CHROMED BRASS:

The chrome finish effect is realized through galvanic process which confers a stainless steel like shine to the brass profile. The visual impact is appreciated and the overall appearance gains from it. High resistance to chemical aggression but limited resistance to mechanical impacts on the surface and to persistent abrasion.



## raw materials



## Thermoplastic synthetic resin

### RESINTOP rigid thermoplastic Synthetic Resin:

Material purposely conceived to optimize the characteristics and performance of the rigid plastic profile for permanent installation both indoors and outdoors to guarantee both endurance and aesthetic quality over time. It is developed with a primary resin base in Polyvinyl Chloride which can bear heat exposure to + 60° C .

It is UV resistant and tolerant to mechanical impact as well as to fungus and bacteria concentrations.

Characteristics	Method	Conditions	Unit of measure	Reference value
Specific Weight	ISO 1183	23°C	Kg/dmc	1,44
Hardness	ISO 868	23°C	Shore D	81
	Vicat	ISO 306	5 kg. °C	80
Breaking Load	ISO 527	23°C	N/mm <sup>2</sup>	42
Elongation	ISO 527	23°C	%	130
IZOD	ISO 180	23°C	J/m	200
Flame Resistance	UL 94	-	Fire Rating	V-0

### RESINIL Co-extruded Thermoplastic Synthetic Resin:

Primary resin material with chemical composition similar to the RESINTOP, featuring high tolerance and compatibility towards thermal forming and co-extrusion process - meaning the coupling of 2 plastic materials with different SHORE hardness rates.

Characteristics	Method	Conditions	Unit of measure	reference value
Specific Weight	ISO 1183	23°C	Kg/dmc	1,47
Hardness	ISO 868	23°C	Shore D	81
	Vicat	ISO 306	5 kg. °C	80
Breaking Load	ISO 527	23°C	N/mm <sup>2</sup>	41
Elongation	ISO 527	23°C	%	120
IZOD	ISO 180	23°C	J/m	200
Flame Resistance	UL 94	-	Fire Rating	V-0





### RESINFLEX soft thermoplastic synthetic resin:

It bears similar chemical characteristics as the RESINIL product with which it is perfectly compatible in the CO-EXTRUSION we use for most of our expansion joints. Its plastic properties allow it to remain elastic over time.

Characteristics	Method	Conditions	Unit of measure	REFERENCE VALUE
Specific Weight	ISO 1183	23°C	Kg/dmc	1,50
Hardness	ISO 868	23°C	Shore A	87
Vicat	ISO 306	5 kg.	°C	-
Breaking Load	ISO 527	23°C	N/mm <sup>2</sup>	15,5
Elongation	ISO 527	23°C	%	300
IZOD	ISO 180	23°C	J/m	-
Flame Resistance	UL 94	-	Fire Rating	V-0

### RESINPRENE Vulcanized Rubber:

RESINPRENE vulcanized rubber is a modified compound NEOPRENE based, whose particular characteristics are reported here below:

Excellent mechanical performance in an operating temperature interval of -40°C to +150°C.

Highly resistant to water base fluids, oils and hydrocarbon substances and lubricants. Low permanent deformation to compression and tensile stress. Excellent resistance to ageing. It is a hard-wearing product and can withstand lacerations. These qualities are essential for the manufacturing of profiles where long lasting performance are required for both indoor and/or outdoor applications.

Characteristics	Method	Conditions	Unit of measure	reference value
Specific Weight	ASTM D-297	25°C	Kg/dmc	0,95
Hardness	ASTM D-2240	25°C	Shore A	70
Breaking Load	ASTM D-412	25°C	MPa	8,3
Critical Point	ASTM D-746	-	°C	-63

### RESISTANCE TO CORROSIVE AGENTS:

The chart below reports the reference resistance to the most common element and corrosion. Polyvinyl Chloride products should generally never be in contact with aromatic hydrocarbons, ketones and esters.

Further information about materials are available from our technical office on written request.

CORROSIVE AGENT	CONCENTRATION	RESINTOP	RESINFLEX	RESINIL	RESINPRENE
Seawater	-	1	1	1	1
Hydrogen Peroxide	20%	1	1	1	1
Vinegar	-	2	2	2	1
Lactic Acid	-	1	3	1	2
Acetic Acid	10%	1	1	1	1
Hydrochloric Acid	35%	1	2	1	1
Acetone	50%	3	3	3	2
Alcoholic Beverage	-	1	2	1	1
Sodium Chloride	-	1	2	1	1
Zinc Chloride	-	1	1	1	1
Glucose	-	1	2	1	1
Hydrocarbons	-	3	3	3	2
Sewage	-	1	2	1	1
Diesel Oil	10%	1	2	1	1
Calcium Sulfate	-	1	2	1	1
Magnesium Salt	-	1	2	1	1
Urine	-	1	1	1	1
Wine	-	1	2	1	1
Wash Water	-	1	1	1	1

- 1= Resistant
- 2= Resistant with reserve
- 3= Not resistant

The tests have been made at 20°C temperature.

## + Colour



11  
Pure white RAL 9010



22  
Grey RAL 7038



41  
Cream RAL 1015



45  
Soft blue no RAL



60  
Corten no RAL



12  
White Ivory RAL 9001



23  
Cement grey RAL 7030



42  
Ivory RAL 1013



46  
Soft green no RAL



61  
Klinker red no RAL



13  
Rustic White no RAL



31  
Beige Bahama no RAL



43  
Peach no RAL



50  
Grey micaceous no RAL



62  
Red Brown no RAL



21  
Light Grey RAL 9018



32  
Dark beige RAL 1019



44  
Soft Pink no RAL



51  
Black RAL 9005



63  
Dark brown no RAL

## + Stone



82  
White marble



85  
Marble Navona



88  
Caramel beige



91  
Peach Pink



94  
Azure - blue



83  
Light travertine



86  
Beige pink



89  
Dove beige



92  
Soft green



95  
Grey marble



84  
Travertine beige



87  
Beige yellow



90  
Antique pink



93  
Brazil green



96  
Stone grey

## + Wood

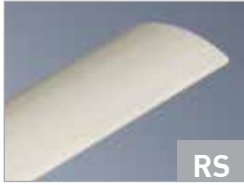

RS

Whitened

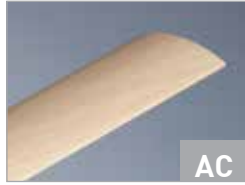

AC

Maple



FA

Beech



RO

Oak



CI

Cherry



NC

Light walnut



NS

Dark walnut



WE

Wengé

## + Metal



AN

Natural aluminium



AO

Aluminium Polished Gold



IL

Polished Stainless Steel



ON

Naturale Brass



AS

Aluminium Silver

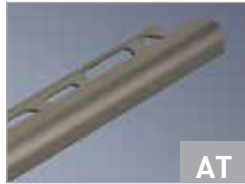

AT

Aluminium Titanium



IS

Brushed Stainless Steel



OL

Polished Brass



AR

Aluminium Copper



ASS

Aluminium Silver Brushed



IX

Sanded Stainless Steel



OC

Chromed Brass

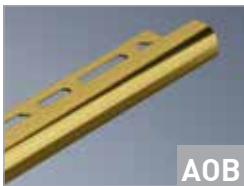

AOB

Aluminium polished Gold



ASB

Aluminium Polished Chrome



ATB

Aluminium polished titanium



ARB

Aluminium polished copper

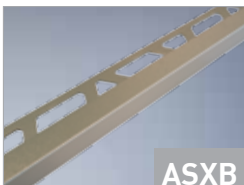

ASXB

Aluminium Silver sanded polished



ACXB

Aluminium champagne sanded polished

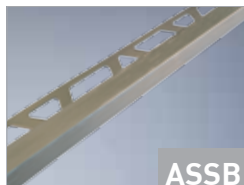

ASSB

Aluminium Silver Brushed polished

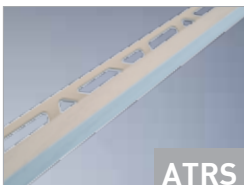

ATRS

Aluminium whitened oak



ATWE

Aluminium wengé



ATTK

Aluminium teak

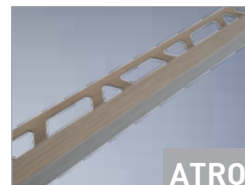

ATRO

Aluminium oak

Code	Family	Product	Function	Page
AD	Profiles for floors	Linotec	Separation	44
AE	Stairnosing	Stairtec	Ribbed on existing floors	92
APP 15	Profiles for wall covering	Appendo	Vertical listello	127
AV/AP/SC	Profiles for floors	Linotec	PVC floors edge	73
BA	Profiles, skirting boards and wall protection	Skirting	Minimal	210
BA	Profiles, skirting boards and wall protection	Skirting	Standard	214
Bandtec	Mattings for tiling	Bandtec	Termoplastic elastomer	206
BAR	Profiles, skirting boards and wall protection	Skirting	Decorative	216
BBS	Perimeter profiles for terraces	Bordertec	Balconies	183
BCO	Perimeter profiles for terraces	Bordertec	Draining profile	184
BD	Perimeter profiles for terraces	Bordertec	Draining screed	182
BF	Profiles, skirting boards and wall protection	Plano	Plano Design	220
BFW	Profiles, skirting boards and wall protection	Plano	Support	225
BI	Profiles, skirting boards and wall protection	Skirting	Bicolor - Design	212
BI	Profiles, skirting boards and wall protection	Skirting	Interlocking	218
BIM	Profiles, skirting boards and wall protection	Skirting	Waterproofing	223
BIM	Perimeter profiles for terraces	Skirting	Skirting	191-223
BO	Perimeter profiles for terraces	Bordertec	Perimeter	185
BOS	Perimeter profiles for terraces	Bordertec	Perimeter	186
BP	Profiles for wall covering	Planotec	Work-top edge	119
BR	Perimeter profiles for terraces	Bordertec	Perimeter	187
BSR	Profiles for floors	Bordertec	Floor / supports edge	33
BSR	Perimeter profiles for terraces	Bordertec	End cap	190
BT	Profiles, skirting boards and wall protection	Skirting	Thin-tiles	222
BTR	Perimeter profiles for terraces	Bordertec	Modular	188
BU	Accessories for laying	Entrytec	Entrance mat framing	258
CA	Expansion Joints	Coflex	Separation thin bed	145
CAJ	Expansion Joints	Coflex	Invisible joint	146
Binding equipment	Profiles for floors	Curveline	Bending machine	47
CB	Expansion Joints	Coflex	Intercheangable	148
CBL	Expansion Joints	Coflex	Intercheangable	149
CD	Expansion Joints	Coflex	Modular deep bed	155
CE	Expansion Joints	Coflex	Separation thin bed	144
CF	Expansion Joints	Coflex	Separation deep bed	154
CK	Expansion Joints	Coflex	Tecnici metal	150
CKM	Expansion Joints	Coflex	Technical for screed	151
CLF	Profiles for floors	Multiclip®	Multiclip 6÷11 mm	60
CLF	Profiles for floors	Multiclip®	Multiclip 12÷18 mm	61
CLG	Profiles for floors	Multiclip®	Multiclip	59
CLG	Profiles for floors	Multifix	Multifix	64
CLP	Profiles for floors	Multiclip®	Multiclip perimeter	62
CLS	Profiles for floors	Multiclip®	Multiclip stairnosing	63
CM	Expansion Joints	Coflex	Modular deep bed	153
CMB	Expansion Joints	Coflex	Modular for screed	152
CO	Profiles for wall covering	KeraCorner	Corner protections	129

Code	Family	Product	Function	Page
CP	Expansion Joints	Coprtec	Coprijoint modular	175
CPM	Expansion Joints	Coprtec	Modular joint	174
CR	Profiles for wall covering	Coflex	Co-extruded cove	134
CR	Expansion Joints	Coflex	Perimeter joint	157
CRM/BT	Profiles for wall covering	CRM - BT	Mosaic	116
CTL	Expansion Joints	Coflex	Grindable joint	147
CTM	Expansion Joints	Coflex	Separation suitable for grinding	156
CU-FI	Profiles for floors	Cubetec	Junction	38
DC	Profiles for floors	Variotec	Edge strip	54
DIC/DIT	Accessories for laying	Spacers	Spacers	254
DIY	Accessories for laying	Profile	Profile generici	260
DK	Profiles for floors	Variotec	Edge strip	55
Draintec 8	Mattings for tiling	Draintec	Drainage	204
EP	Profiles for floors	Covertec	Junction	39
ER	Profiles for wall covering	Sanitec	Resin cove	135
FI	Profile for stair nosing	Stairtec	Stain. steel for ceramic tiles	79
FL	Profile for stair nosing	Stairtec	Decorative for ceramic tiles	82
FL	Profile for stair nosing	Stairtec	Dec. st. steel for ceramic	83
FO	Profile for stair nosing	Stairtec	Technical nosing for wood/ ceramic	87
Foiltec	Mattings for tiling	Foiltec	Waterproofing	200
FS	Profile for stair nosing	Stairtec	Ceramic tiles	78
FSF	Profile for stair nosing	Stairtec	Ceramic tiles	76
FSL	Profile for stair nosing	Stairtec	Ceramic tiles	77
FW	Profile for stair nosing	Stairtec	Wood for ceramic	80
GA	Expansion Joints	Jointec	Structural floor	163
GAD	Expansion Joints	Jointec	Coprijoint floor	172
GADP	Expansion Joints	Jointec	Coprijoint wall	173
GAL	Expansion Joints	Jointec	Structural floor	162
GALP	Expansion Joints	Jointec	Structural floor-wall	164
GAP	Expansion Joints	Jointec	Structural floor-wall	165
GC	Expansion Joints	Jointec	Concrete floors	176
GD	Expansion Joints	Jointec	Coprijoint	170
GDM	Expansion Joints	Jointec	Coprijoint high performance	171
GE	Expansion Joints	Jointec	Structural	158
GH	Expansion Joints	Jointec	Structural carriageable	166
GI/GIL	Expansion Joints	Jointec	Insert	179
GM	Expansion Joints	Jointec	Structural modular	161
GR	Expansion Joints	Jointec	Structural	159
GRM	Expansion Joints	Jointec	Structural high performance	160
GS	Expansion Joints	Jointec	Seismic expansion joint	168
GT	Expansion Joints	Jointec	Industrial floors	178
GW	Expansion Joints	Jointec	Structural waterproof	167
IC	Profiles, skirting boards and wall protection	Sanitec	Sanitec-skirting	226
IC	Profiles for wall covering	Sanitec	Junction	136
IJ	Profiles for wall covering	InterJolly	Corner profile	137



Code	Family	Product	Function	Page
K	(N) Draining systems	Profile Drain	Sloping profiles	238
KJ	Profiles for wall covering	KeraJolly	Finish	110
LD	(N) Draining systems	Linear Drain	Linear for shower trays	232
LD	(N) Draining systems	Linear Drain	Linear for shower trays	234
LEV	(N) Accessories for laying	Leveltec	Sistema levelling system	248
LG	Profiles for floors	Woodtec	Wood junction	69
LI 10	(N) Profiles for wall covering	Listec	Decorative listello	122
LI 10 glitter	(N) Profiles for wall covering	Listec	Glitter Listello	124
LI 15	(N) Profiles for wall covering	Listec	Decorative listello	123
LI 15 glitter	(N) Profiles for wall covering	Listec	Glitter Listello	125
LI 20/22	(N) Profiles for wall covering	Listec	Decorative listello	121
LIA	(N) Profiles for wall covering	Listelli	Shim for listellos	126
LIM 44	Profiles for wall covering	Mosaictec	Decorative mosaic	118
LIM 51	Profiles for wall covering	Mosaictec	Decorative mosaic	117
LP	Profiles for floors	Woodtec	Wood end cap	68
LT	Profiles for floors	Woodtec	Wood end cap	67
MAG	Accessories e complementi per la posa	Magtec	Magnets for tiled panels	257
MA/MS/MD	Profiles for floors	Carpetec	End cap moquettes	72
MB	Profiles for floors	Linetec	Separation	45
MG	Profiles for floors	Carpetec	Carpet junction	70
MP	Profiles for floors	Carpetec	Edge	71
MUD	(N) Draining systems	Multidrain	Modular for outdoor	240
MUD	(N) Draining systems	Multidrain	Modular for outdoor	242
Multiclip	Profiles for floors	Multiclip	Multiclip	58
Multicover	Profiles for floors	Multicover	Wood	66
Multifix	Profiles for floors	Multiclip	Multiclip-Multifix mounting	65
P	Expansion Joints	Jointec	Perimeter modular	169
PD	Perimeter profiles for terraces	Copridrain	Drain well	189
PS130	Profiles, skirting boards and wall protection	Plano	Plasterboard	224
PT	Profiles for floors	Linetec	Separation	46
RD	(N) Profiles for floors	Roundtec	Transition	40
RE	Profiles for wall covering	RoundCorner	Corner edge for tiles	132
RJ	(N) Profiles for floors	Roundjolly	"Ultra-thin" tiles	34
RJ	(N) Profiles for wall covering	RoundJolly®	Junction	106
RJ/SJM	Profile for stair nosing	RJ - SJM	Ultra-thin tiles	86
RJE	Profiles for wall covering	RoundJolly®	Co-extruded profile	108
RJF	(N) Profiles for wall covering	Filojolly	Invisibile	105
RJF	Profiles for wall covering	Mosaictec	Mosaic	114
RJM	Profiles for wall covering	Mosaictec	Mosaic	113
RJ/RD	Profile for stair nosing	Serie	Tiled steps	84
RO	Profiles for wall covering	RoundCorner	Round corner protections	128
RP	Profiles for floors	Leveltec	Existing floors	52
RP	Profiles for floors	Leveltec	Existing floors	53
RS/IL	(N) Profiles for wall covering	Sanitec	Stainless Steel internal cove	131
SA	Profile for stair nosing	Stairtec	Aluminium anti-slip	94

Code	Family	Product	Function	Page
SB	Profiles for wall covering	Sanitec	Prof. for bathtub, show. trays	138
SB	Profiles for wall covering	Sanitec	Methacr. f. batht.,show. trays	139
SB	Profiles for wall covering	Sanitec	Multipurpose junction	140
SB15-IL	(N) Profiles for wall covering	Sanitec	Junction	133
SB-IL	(N) Profiles for wall covering	Sanitec	Stainless steel internal cove	130
SC	Profile for stair nosing	Stairtec	Vynil floors	97
SD	(N) Draining systems	Square Drain	Square	236
SE	(N) Profile for stair nosing	Stairtec	Aluminium safety step	93
SET	Accessories e complementi per la posa	SET	Floating floors	256
SI	Profile for stair nosing	Stairtec	Stainless steel on existing floors	91
SJ	(N) Profiles for floors	Squarejolly	Junction	36
SJ	(N) Profiles for wall covering	Squarejolly	Multi-purpose	102
SJ	Profiles for wall covering	Squarejolly	Multi-purpose	104
SJ	Profile for stair nosing	Squarejolly	Square for ceramic	85
SJM	Profiles for floors	Mosaictec	Thi-tiles	35
SJM	Profiles for wall covering	Mosaictec	Mosaic	112
SJQ	Profiles for wall covering	Squarejolly	Square listello	120
SL	Profile for stair nosing	Stairtec	On existing surfaces	96
SLO	(N) Draining systems	Slope Drain	Shower tray	244
SM	Profile for stair nosing	Stairtec	Moquette	98
SM	Profile for stair nosing	Stairtec	Moquette	99
Soltec	Membrane per la posa ceramica	Soltec	Floor installation	202
SP	Profiles for floors	Covertec	Junction	48
SR	(N) Profiles for floors	Trimtec	Perimeter edge	32
SR	(N) Perimeter profiles for terraces	Trimtec	Perimeter edge	196
SR	(N) Profile for stair nosing	Stairtec	Metal for ceramic tiles	81
ST	(N) Profiles for floors	Striptec	Existing floors	50
ST/SB	Profiles for floors	Striptec	Existing floors	51
SUPA	(N) Perimeter profiles for terraces	Support	Supports self leveling head	194
SUPA	(N) Accessories for laying	Support	Supports self leveling head	252
SUPF	(N) Perimeter profiles for terraces	Support	Supports fix head	192
SUPF	(N) Accessories for laying	Support	Supports fix head	250
SW	Profile for stair nosing	Stairtec	Aluminium anti-slip	90
SWH	Profile for stair nosing	Walktec	Anti-slip self-adhesive	95
SWP	(N) Profile for stair nosing	Stairtec	Pacer circular element in st. steel	88
SWR	Profile for stair nosing	Stairtec	Circular anti-slip element in st. steel	89
TJ	(N) Profiles for wall covering	Trialjolly	Corner profile	115
TR	(N) Profiles for floors	Trimtec	Multipurpose	30
Variotec	Profiles for floors	Variotec	Compensating edge	56
WA	Profiles, skirting boards and wall protection	Wallprotection	Corner protection	229
WB	Profiles, skirting boards and wall protection	Wallprotection	Solid coloured	227
WP	Profiles, skirting boards and wall protection	Wallprotection	Wall protection	228
ZP	Profiles for floors	Leveltec	Junction	57
ZR	(N) Profiles for floors	Zerotec	Junction ramp	42
ZRM	Profiles for floors	Zerotec	Transition	41
ZRR	Profiles for floors	Rampotec	Junction ramp	43



# Warranties and responsibilities

## Codes key:

**Code article / section profilo**  
 Article Code / Profile section  
 Artikelnummmr / Profiltyp  
 Réf. Article / Section du Profil  
 Cod. Artículo / Sección perfil  
 Код Изделия / Сечение Профиля

**Size principale / Height-Width**  
 Main measure / Height-Width  
 Abmessungen / Höhe – Breite  
 Mesure principale / Hauteur-Largeur  
 Medida principal / Altura-Anchura  
 Основной Размер / Высота-Ширина

**Length profilo**  
 Profile length  
 Profillänge  
 Longueur du profil  
 Largura del perfil  
 Длина Профиля



**Material / Finish**  
 Material / Finish  
 Material / Feinbearbeitung  
 Matériau / Finition  
 Material / Decoracion  
 Материал / Отделка

### THIS CATALOGUE REPLACES THE FORMER VERSION

Non-contractual document released under reserve of printing errors. Before adopting the recommendations and suggestions here reported, we kindly ask you to check that the articles you have chosen meet your requirements and targets and are suitable to the required rates of mechanical and chemical resistance. Calculations regarding loads, positioning, mechanical and chemical resistance as well as the suitability of each single profile / movement joint and structural joint and the consequent choice of such articles, should be necessarily evaluated by a competent planner.

Profilitec SpA accepts no responsibility nor will offer any explicit or implicit warranty for wrong choice of articles or of installation and misuse of the materials, nor for possible delays in delivery. In case of damage due to faulty material or to errors in production we will bear only the charge of the replacement of the faulty goods. Profilitec accepts no responsibility whatsoever for the consequences arising from an incorrect employment of products. Profilitec spa. reserves the right to make changes to products, packaging and any other element without obligation of prior notice.

In the catalogue "patented system" refers to an Italian patent and for some of them with an extension to other countries.

We wish to thank all those who assisted in the creation of this catalogue, which may almost be considered a guide for the development of laying techniques in particular and of building technique in general.

The best way to show appreciation for Profilitec's professionalism and the quality of the products is to try them for yourself.



© Copyright by Profiletec SpA 36040 Torri di Q.Io (VI) Italy  
Printed May 2015.

ALL RIGHTS RESERVED

All logos, photos, drawings, names and texts included in this catalogue  
contenuti in questo catalogo senza autorizzazione scritta di Profiletec SpA.

Catalogo tecnico Profiletec SpA  
Code CAT-TEC15/EN  
Draft April 2015  
Revisione DIR./02

Distribution not controlled.







**Profilitec SpA socio unico**  
Via Brescia, 43  
36040 Torri di Quartesolo  
(Vicenza) ITALY  
[www.profilitec.com](http://www.profilitec.com)

**Contacts:**  
tel +39 0444 268311  
fax +39 0444 268319  
e-mail [profilitec@profilitec.com](mailto:profilitec@profilitec.com)  
[export@profilitec.com](mailto:export@profilitec.com)



- + PROFILES FOR FLOORS
- + PROFILES FOR STAIR NOSING
- + WALL COVERINGS PROFILES
- + EXPANSION JOINTS
- + PERIMETER PROFILES FOR BALCONIES
- + MATTINGS FOR TILE INSTALLATION
- + SKIRTING BOARDS AND WALL PROTECTION
- + DRAINING SYSTEMS
- + ACCESSORIES FOR LAYING